

Luxury design



organizer/listino 2022



FLORIM È CERTIFICATA B CORP

FLORIM IS B CORP CERTIFIED

Guardiamo al business come una forza positiva in grado di generare profitto e allo stesso tempo creare un impatto virtuoso sulle persone e sull'ambiente. Da sempre.

Le nostre scelte, giorno dopo giorno, ci hanno portato a migliorare il nostro modo di fare impresa.

We conceive the business as a positive force able to generate profits and at the same time create a virtuous impact on people and the environment. Since forever.

Our choices, day after day, have led us to improve our way of doing business.

COSA SIGNIFICA ESSERE B CORP?

Ci siamo misurati con i **più alti standard di performance sociale e ambientale** e dopo un lungo e rigoroso processo di verifica **siamo diventati B Corp.**

Le aziende che riescono a ottenere questa certificazione sono le più evolute al mondo in termini di impatto positivo sia sociale che ambientale.

Costituiscono un movimento globale di 'Purpose Driven Businesses' che ha l'obiettivo di diffondere un nuovo **paradigma economico**, che vede le imprese come protagoniste nel **rigenerare la società.**



Certified



Corporation



Guarda il video *"Essere sostenibili è una scelta quotidiana"* con i volti di alcune delle "persone Florim" che ogni giorno contribuiscono a rendere l'azienda sempre più responsabile.

Watch the video "Being sustainable is a daily choice" with the faces of some of the "Florim people" who contribute to making the company even more responsible, every day.

WHAT DOES IT MEAN TO BE B CORP?

We vied with the **highest social and environmental performance standards**, and after a long and scrupulous verification process, **we became B Corp.**

Companies that succeed in obtaining this certification are the most evolved in the world in terms of their positive social and environmental impact.

They constitute a global movement of 'Purpose Driven Businesses' whose aim is to diffuse a **new economic paradigm**, whereby companies are the drivers of **social regeneration.**

**FOR
PROFIT**

Ricerca
il profitto
Seeks profit

Certified



Corporation

Ricerca il profitto e ha un impatto positivo sulle persone e l'ambiente
Seeks profit and has a positive impact on people and the environment

**NON
PROFIT**

Ha un impatto positivo sulle persone e l'ambiente
Has a positive impact on people and the environment

BUSINESS RIGENERATIVO

È in corso un **cambiamento culturale** epocale di cui siamo orgogliosi di essere parte. Uno dei principi fondamentali di tutte le B Corp è quello di adottare un business rigenerativo che si contrappone a quello estrattivo.

Rigenerare significa non solo diminuire l'impatto sulla natura e sull'ambiente che ci circonda, ma addirittura produrre effetti positivi, creando valore condiviso nella società e rigenerando la biosfera.

Diventano B Corp solo quelle aziende che misurano il loro impatto complessivo attraverso il Benefit Impact Assessment (BIA) superando il punteggio di 80 (in una scala da 0 a 200) ed entrando così in una élite di imprese **rigenerative**. Chi non supera questa soglia viene considerata **azienda estrattiva** ovvero per funzionare consuma risorse economiche, sociali e ambientali superiori di quanto sia in grado di generare come output.

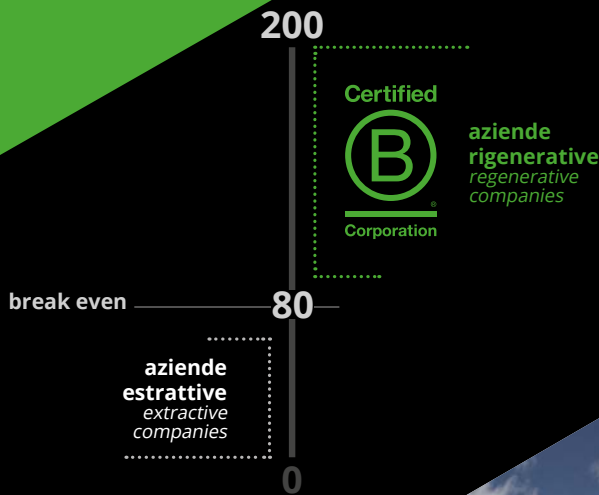

REGENERATIVE BUSINESS

An historical **cultural shift** is under way, of which we are proud to be a part. One of the underlying principles of all B Corps is the adoption of a regenerative business model as opposed to an extractive one.

Regenerating means not only reducing the impact of business on our surrounding nature and environment, but also producing **positive effects, creating shared value in society and regenerating the biosphere.**

Only those companies that measure their overall impact through the Benefit Impact Assessment (BIA) exceeding the score of 80 points can be certified as B Corp, joining an elite of **regenerative companies**. Anyone who does not exceed this threshold is considered an **extractive company** or, in order to function, they consume higher economic, social and environmental resources than they are able to generate as output.

IL PUNTEGGIO DI FLORIM

Il punteggio conseguito da Florim Italia è di 98,1 punti e il consolidato, che comprende la consociata americana, è di 90,9 punti. Così il Gruppo Florim rientra tra le 3.700 B Corp al mondo.

Sono oltre 140.000 le aziende che stanno cercando di ottenere la certificazione, nel rispetto di **severissimi standard di trasparenza e sostenibilità.**

Solo il 3% riesce a superare l'iter di verifica imposto da **B Lab**, ente certificatore di origine americana che oggi opera a livello globale.

FLORIM'S SCORE

Florim Italia score is 98.1 points and the consolidated, which includes the American subsidiary, is 90.9 points. Florim Group is now one of the 3,700 B Corps throughout the world.

More than 140,000 companies are currently seeking to obtain the certification **in compliance with the strictest transparency and sustainability standards.**

Only 3% manage to pass the verification process implemented by **B Lab**, the US certifying body that currently operates on a global scale.

90.9

Florim consolidato
Florim consolidated

98.1

Florim Italia
Florim Italy

Azienda

Produciamo superfici ceramiche da quasi 60 anni con **passione, innovazione, impegno costante al miglioramento e responsabilità sociale** d'impresa. Sono queste le linee guida che contraddistinguono il nostro modo di fare impresa: il **MADE IN FLORIM**.

We produce porcelain stoneware surfaces with **passion, innovation and in a socially responsible way**. Those are the guidelines that identify our business and which can be summed up in a few words: **MADE IN FLORIM**.

Nous produisons des surfaces céramiques depuis près de 60 ans avec **passion, innovation, recherche et une attention à la responsabilité sociale d'entreprise**. Ce sont les lignes phares qui guident notre mode de travailler: le **MADE IN FLORIM**.

Wir produzieren seit fast 60 Jahren Keramikoberflächen mit **Leidenschaft, Innovationsgeist, ständigem Engagement für Verbesserungen und sozialer Unternehmensverantwortung**. Dies sind die Prinzipien, die unsere Arbeitsweise auszeichnen: kurz **MADE IN FLORIM**.

Producimos superficies cerámicas desde hace casi 60 años con **pasión, innovación, compromiso de mejora constante y responsabilidad social**. Estos son los valores distintivos de nuestro modo de hacer empresa: el **MADE IN FLORIM**.

Мы производим керамогранитные поверхности социально ответственным образом со страстью и инновациями. Это основные принципы, которые определяют наш бизнес и которые могут быть кратко изложены в нескольких словах: **MADE IN FLORIM**.



Luxury design

Materiali prestigiosi e ricercati delle materie più preziose che la natura propone. Lusso ostentato o sofisticato uso della materia per un'eleganza più informale e decisa. Rara, preziosa e intimamente legata al vivere dell'uomo, la materia viene reinterpretata nell'esprimere il concetto dell'ambiente moderno.

Prestigious and exquisite materials made of the most precious materials that nature has to offer. Ostentatious luxury or sophisticated use of materials for a more informal and bold elegance. Rare, luxurious and intimately linked to everyday life, the material is reinterpreted to convey the concept of a modern environment.

Des matériaux prestigieux et recherchés à partir des matières les plus précieuses offertes par la nature. Luxe ostentatoire ou utilisation sophistiquée de la matière pour une élégance plus informelle et audacieuse. Rare, précieuse et intimement liée à l'existence de l'homme, la matière est réinterprétée à travers l'expression du concept d'environnement moderne.

Kostbare, edle Materialien aus den wertvollsten Stoffen, die die Natur zu bieten hat. Betonter Luxus oder anspruchsvoller Einsatz des Materials für eine eher informelle und offensichtliche Eleganz. Das Material - selten, wertvoll und eng mit dem Leben des Menschen verbunden - wird neu interpretiert, um das Konzept des modernen Ambiente zum Ausdruck zu bringen.

Productos prestigiosos y refinados, de las materias más preciosas que la naturaleza ofrece. Lujo ostentado o sofisticada utilización de la materia, con el fin de obtener una elegancia más informal y decidida. Rara, preciosa e íntimamente ligada a la vida del hombre, la materia es reinterpretada para expresar el concepto del ambiente moderno.

Роскошные и изысканные покрытия, воссоздающие самые ценные природные материалы. Вычурная роскошь или изящное использование материи для создания более неформальной и яркой элегантности. Редкий, ценный и тесно связанный с повседневной жизнью человека материал переосмысливается в новом ключе и выражает концепцию современного интерьера.

elegance



preciousness



exclusivity



charm

Indice



gres porcellanato colorato in massa

coloured body porcelain stoneware / grès cérame colore dans la masse
durchgefärbte feinsteinzeug / gres porcelánico coloreado en masa
керамогранит, окращенный по всей тлщине

40/49	Étoile de rex
62/77	I classici di rex
102/107	I marmi di rex
118/127	Les bijoux de rex
128/135	Les origines de rex
158/167	Prexious of rex
168/177	Rêves de rex

vetro

glass / verre / glas / vidrio / стекло

50/55	Extra light
56/61	Gold

gres fine porcellanato

fine porcelain stoneware / grès cérame fin
feinsteinzeug-kollektionen / gres porcelánico fino
фарфоровый керамогранит

12/21	Ardoise
22/39	Atmosphères de rex
62/71	I classici di rex/Decowood
108/117	La roche di rex
136/147	Matières de rex
148/157	Planches de rex
178/187	Selection oak

gres porcellanato decorato

decorated porcelain tiles
grès cérame décoré
verziertes feinsteinzeug
gres porcelánico decorado
ДЕКОРИРОВАННЫЙ КЕРАМОГРАНИТ

78/101	I filati di rex
---------------	-----------------



La simbologia

SYMBOL/SYMBOLS/SYMBOL/SIMBOLOGIA/Символы

DIN 51130: Scivolosità a piedi calzati: il materiale ceramico viene posto su un piano e oliato. Successivamente il piano viene progressivamente inclinato ,mentre un operatore con scarpa di gomma cammina lungo il piano fino a quando non inizia a scivolare; la misura dell'angolo che si forma tra il piano inclinato e il suolo all'inizio dello scivolamento determina la classificazione del materiale. / Shod foot slipperiness: the ceramic material is placed on a surface and oiled. Subsequently, the surface is progressively tilted, while an operator with rubber shoes walks along the surface until he starts to slip; the measurement of the angle that is formed between the inclined surface and the ground when the slipping starts determines the classification of the material. / Glissance pieds chaussés : le matériau céramique est mis sur un plan et huilé. Le plan est ensuite incliné progressivement, tandis qu'un opérateur avec des chaussures en caoutchouc marche le long du plan jusqu'à ce qu'il ne commence à glisser ; la mesure de l'angle qui se forme entre le plan incliné et le sol au début du glissement donne la classification du matériau. / Rutsicherheit auf Schuhen: Das Keramikmaterial wird auf einer Fläche angebracht und mit einem Gleitmittel bestrichen. Daraufhin wird die Fläche nach und nach geneigt, während eine Prüfperson mit Gummischuhen die Fläche entlangläuft, bis sie ins Rutschen gerät. Die Größe des Winkels, der zwischen der geneigten Fläche und dem Boden zu Beginn der Rutschtbewegung entsteht, bestimmt die Klassifizierung des Materials. / Deslizamiento con pies descalzos: el material cerámico se coloca sobre un plano y se aceita. Seguidamente el plano se inclina progresivamente, mientras que un operador con calzado de goma camina a lo largo del plano hasta que empieza a resbalar; la medida del ángulo que se forma entre la superficie inclinada y el suelo al principio del deslizamiento determina la clasificación del material. / **устойчивость к скольжению при хождении в обуви: керамический материал укладывается на поверхность и покрывается маслом. Затем поверхность постепенно наклоняется, а оператор в резиновой обуви ходит по поверхности до тех пор, пока не начинает скользить; размер угла, образованного наклоненной поверхностью и основанием на момент начала скольжения определяет классификацию материала**

DIN 51097: Scivolosità a piedi nudi: il materiale ceramico viene posto su un piano e bagnato. Successivamente il piano viene progressivamente inclinato ,mentre un operatore con piede nudo cammina lungo il piano fino a quando non inizia a scivolare; la misura dell'angolo che si forma tra il piano inclinato e il suolo all'inizio dello scivolamento determina la classificazione del materiale. / Barefoot slipperiness: the ceramic material is placed on a surface and made wet. Subsequently, the surface is progressively tilted, while an operator with bare feet walks along the surface until he starts to slip; the measurement of the angle that is formed between the inclined plane and the ground when slipping starts determines the classification of the material. / Glissance pieds nus : le matériau céramique est mis sur un plan et mouillé. Le plan est ensuite incliné progressivement, tandis qu'un opérateur pieds nus marche le long du plan jusqu'à ce qu'il ne commence à glisser ; la mesure de l'angle qui se forme entre le plan incliné et le sol au début du glissement donne la classification du matériau. / Rutsicherheit barfuß: Das Keramikmaterial wird auf einer Fläche angebracht und befeuchtet. Daraufhin wird die Fläche nach und nach geneigt, während eine Prüfperson barfuß die Fläche entlangläuft, bis sie ins Rutschen gerät. Die Größe des Winkels, der zwischen der geneigten Fläche und dem Boden zu Beginn der Rutschtbewegung entsteht, bestimmt die Klassifizierung des Materials. / Deslizamiento con pies descalzos: el material cerámico se pone sobre un plano y se moja. Seguidamente el plano se inclina progresivamente, mientras que un operador con los pies descalzos camina a lo largo del plano hasta que empieza a resbalar; la medida del ángulo que se forma entre la superficie inclinada y el suelo al principio del deslizamiento determina la clasificación del material. / **устойчивость к скольжению при хождении босиком: керамический материал укладывается на поверхность и смачивается водой. Затем поверхность постепенно наклоняется, а оператор ходит босиком по поверхности до тех пор, пока не начинает скользить; размер угла, образованного наклоненной поверхностью и основанием на момент начала скольжения определяет классификацию материала.**

DCOF: Coefficiente di attrito dinamico: viene misurata la forza necessaria per mantenere in movimento un elemento (BOT 3000) rivestito in gomma dalla superficie della piastrella in condizioni di superficie bagnata; il rapporto tra la forza necessaria e il peso dell'elemento scivolante indica il Coefficiente di attrito dinamico. / Dynamic coefficient of friction: the force required to maintain the movement of an element (BOT 3000) coated with rubber on the surface of the tile in wet surface conditions is measured; the relationship between the force required and the weight of the slipping element indicates the dynamic coefficient of friction. / Coefficient de frottement dynamique : la force nécessaire pour maintenir en mouvement un élément (BOT 3000) revêtu en caoutchouc sur la surface du carreau en conditions de surface mouillée est mesurée ; la relation entre la force nécessaire et le poids de l'élément glissant indique le coefficient de frottement dynamique. / Dynamischer Reibungskoeffizient: Gemessen wird die Kraft, die erforderlich ist, um ein Element mit Gummiverkleidung (BOT 3000) durch die Fliese bei nasser Oberfläche in Bewegung zu halten. Das Verhältnis zwischen der erforderlichen Kraft und dem Gewicht des gleitenden Elements gibt den dynamischen Reibungskoeffizienten wieder. / Coeficiente de fricción cinética: se mide la fuerza necesaria para mantener en movimiento un elemento (BOT 3000) revestido de goma por la superficie de la baldosa bajo condiciones de superficie mojada; la relación entre la fuerza necesaria y el peso del elemento que resbala indica el Coeficiente de fricción dinámica. / **коэффициент динамического трения: измеряется сила, необходимая для поддержания одного элемента (BOT 3000) с резиновым покрытием в движении на плитке в условиях влажной поверхности; соотношение между необходимой для этого силой и весом элемента является коэффициентом динамического трения.**

SQUADRATO / SQUARED / EQUARRI / REKTIFIZIERT / ESCUADRADO /Калиброванная

Piastrelle o lastre ceramiche portate a dimensioni predefinite, ognuno esattamente uguale all'altra (monocalibro) con sistema di mole abrasive. / Ceramic tiles or slabs made to a pre-defined size, each one exactly the same as the others (single size), using a system of abrasive grinders. / Carreaux ou dalles céramiques mises aux dimensions prédéfinies, parfaitement identiques l'une à l'autre (mono-calibre) grâce à un système de disques abrasifs. / Fliesen oder Keramikplatten mit festgelegten Formaten. Alle Fliesen sind aufgrund der Verwendung des Schleifscheiben-Systems hundertprozentig identisch (Monokaliber). / Baldosas o piezas de cerámica que se realizan con dimensiones predefinidas, cada pieza es exactamente igual a la otra (mono dimensión) con sistema de discos abrasivos. / **Керамическая плитка или плиты, доведенные шлифовальными кругами до установленных размеров, все изделия одинаковы (один калибр).**

Grado di variazione cromatica

DEGREE OF COLOUR CHANGE/DEGRE DE VARIATION CHROMATIQUE/GRAD DER FARBABWEICHUNG/GRADO DE VARIACIÓN CROMÁTICA/
СТЪПЪНЬ ХРОМКИЧЪСКООО ИЗМЪНЪНИЯ

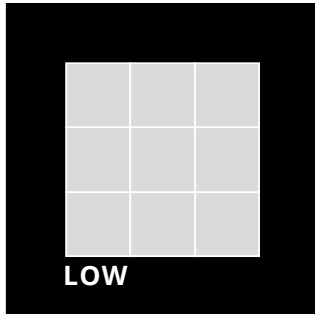

v1

PRODOTTO MONOCROMATICO.

The least amount of shade and texture variation.

Attainable in naturally fired clay products.

Produit monochromatique.

Eifarbiges produkt.

Producto monocromático.

ОДНОЦВЕТНАЯ ПРОДУКЦИЯ.

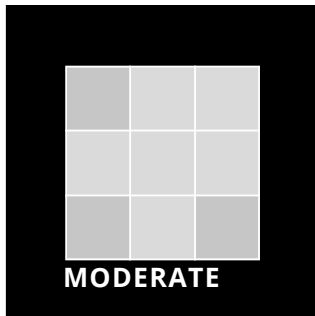

v2

PRODOTTO CON LEGGERA VARIAZIONE CROMATICA.

Light to moderate shade and texture variation within each carton.

Produit à légère variation chromatique.

Produkt mit leichter farbnuance.

Producto con una pequeña variación cromática.

ПРОДУКЦИЯ С ЛЕГКИМИ ЦВЕТОВЫМИ ИЗМЕНЕНИЯМИ.

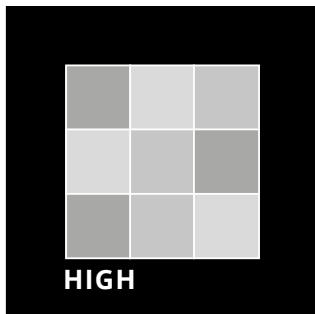

v3

PRODOTTO CON MARCATA VARIAZIONE CROMATICA.

High shade texture variation within each carton.

Produit à variation chromatique accentuée.

Produkt mit ausgeprägter farbnuance.

Producto con evidente variación cromática.

ПРОДУКЦИЯ С ЯРКИМИ ЦВЕТОВЫМИ ИЗМЕНЕНИЯМИ.

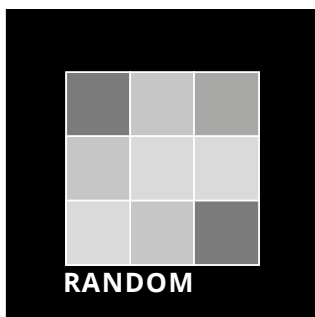

v4

PRODOTTO CON FORTE VARIAZIONE CROMATICA.

Very high shade and texture variation within each carton.

Produit à forte variation chromatique.

Produkt mit starker farbnuance.

Producto con fuerte variación cromática.

ПРОДУКЦИЯ С СИЛЬНЫМИ ЦВЕТОВЫМИ ИЗМЕНЕНИЯМИ.

Superfici

SURFACES/SURFACES/OBERFLÄCHEN/SUPERFICIES/ПоверхностиСимволы

Naturale - Sablé / Matte / Mat / Matt / Mate / Натуральная

Superficie risultante dalla produzione di piastrella pressata senza lavorazioni successive alla cottura. / Surface coming from manufacturing pressed tiles without further work after firing. / Surface résultant de la production d'un carreau pressé sans être travaillé après la cuisson. / Die Oberfläche entsteht durch das Fliesenpressverfahren - im Anschluss an das Brennen erfolgt keine weitere Bearbeitung. / Superficie que resulta de la producción de baldosa prensada sin ulteriores elaboraciones después de la cocción. / Поверхность, получаемая в результате производства прессованной плитки, без выполнения обработки после обжига.

Strutturato - Structuré / Structured / Structuré / Strukturiert / Estructurado / Структурированный

Superficie risultante dalla produzione di piastrella pressata, a tampono non liscio con intensità di evidenza variabile (da leggera ondulazione ad imitazione di pietra tagliata), senza lavorazioni successive alla cottura. / Surface coming from manufacturing pressed tiles, using a rough pad with variable intensity (from a slightly undulating one to inspired cut stone), without processing after firing. / Surface résultant de la production d'un carreau pressé, par un tampon à relief avec une intensité d'aspect variable (de légère ondulation à l'inspiration de la pierre taillée), sans être travaillé après la cuisson. / Die Oberfläche beruht auf dem Produktionsverfahren der Fliesenpressung unter Verwendung eines unglatten Stempels mit Intensitätsvariation (leichte Wellung entsprechend eines geschnittenen Steins). Es erfolgt keine Weiterbearbeitung nach dem Brennen. / Superficie que resulta de la producción de baldosa prensada, con tampón no liso con intensidad de evidencia variable (de ligera ondulación a imitación de piedra cortada), sin ulteriores elaboraciones después de la cocción. / Поверхность, получаемая в результате производства прессованной плитки, с использованием негладкого тампона, с переменной заметностью (от легкой волнистости до имитации разрезанного камня), без выполнения обработки после обжига.

Glossy - Shiny

Superficie ottenuta dopo la cottura sottoponendo le lastre a spazzolatura e lucidatura meccanica con serie di utensili abrasivi a grana decrescente. La superficie finale è morbida, lucida e riflettente. / Surface obtained after firing subjecting the slabs to mechanical brushing and polishing with a series of decreasing grain abrasive utensils. The final surface is soft, glossy and reflective. / Surface obtenue après cuisson, en soumettant les dalles à un brossage et un polissage mécanique avec un jeu d'outils abrasifs de grain décroissant. La surface finale est douce, brillante et réfléchissante. / Oberfläche, die nach dem Brand erhalten wurde, indem Platten mit einer Serie von Reibwerkzeugen mit kleiner werdender Struktur einer mechanischen Bürstung und Politur unterzogen wurde. Die fertige Oberfläche ist weich, glänzend und reflektierend. / Superficie obtenida después de la cocción sometiendo las losas a un procedimiento de cepillado y pulido mecánico con una serie de utensilios abrasivos de grano decreciente. La superficie final es suave, brillante y reflectante. / Эта поверхность получена после обжига, подвергая плиты механической щеточной обработке и полировке, используя абразивный инструмент с уменьшающейся зернистостью. Готовая поверхность является мягкой, полированной и отражающей.

Superficie R+PTV / R+PTV Surface / Surface R+PTV / Oberfläche R+PTV / Superficie R+PTV / Поверхность R+PTV

Superficie ottenuta dalla produzione di piastrella con tampone opportunamente sagomato così da raggiungere precise caratteristiche di sicurezza misurate secondo i principali metodi normativi in uso. La superficie finale è leggermente ruvida, opaca e conforme ai requisiti di scivolosità R10 (norma di riferimento DIN 51130) e scivolosità Pendolo >36 wet (slider 96, norma di riferimento BS 7976 -AS/NZS 4586).

Surface obtained from the production of tiles with appropriately shaped die in order to achieve precise safety characteristics measured based on the main prevailing regulatory methods in use. The final surface is slightly rough, matt and complies with R10 slipperiness requirements (reference standard DIN 51130) and Pendulum slipperiness >36 wet (slider 96, reference standard BS 7976 -AS/NZS 4586). / Surface obtenue à partir de la production de carreaux avec tampon opportunément façonné de manière à satisfaire des caractéristiques de sécurité précises, mesurées suivant les principales méthodes réglementaires en vigueur. La surface finale est légèrement rugueuse, mate et répond aux exigences de la classe de glissance R10 (norme de référence DIN 51130) et de glissance - test du pendule - humide - valeur >36 (slider 96, norme de référence BS 7976 -AS/NZS 4586). / Durch die Produktion von Fliesen mit entsprechend geformter Kachelunterlage erhaltene Oberfläche, um präzise Sicherheits-Charakteristiken zu erzielen, gemessen nach den wichtigsten angewandten Regelungsmethoden. Die fertige Oberfläche ist leicht angeraut, matt und konform mit den rutschhemmenden Eigenschaft R10 (Bezugsnorm DIN 51130) und der Rutschfestigkeit Pendolo >36 wet (slider 96, Bezugsnorm BS 7976 -AS/NZS 4586). / Superficie obtenida de la producción de baldosas con un molde específicamente fabricado para alcanzar características precisas de seguridad de conformidad con los principales métodos normativos vigentes. La superficie final es ligeramente áspera, opaca y conforme a los requisitos de resistencia al deslizamiento R10 (norma de referencia DIN 51130) y resistencia al deslizamiento Péndulo >36 mojado (slider 96, norma de referencia BS 7976 -AS/NZS 4586). / Эта поверхность создается во время производства плитки при помощи специального фасонного тампона, позволяющего получать точные характеристики безопасности, измеренные в соответствии с основными методами, предусмотренными стандартами. Конечная поверхность является слегка шершавой, матовой и соответствует требованиям сопротивления скольжению R10 (справочный стандарт - DIN 51130) и сопротивления скольжению методом маятника >36 в мокром состоянии (образец 96, справочный стандарт BS 7976 -AS/NZS 4586).

Soft

Superficie risultante dalla produzione di piastrella pressata, sottoposta a lavorazione meccanica di intensità intermedia, successiva alla cottura per dare alla superficie una finitura morbida e lievemente satinata, levigata ma non riflettente. / Surface coming from manufacturing pressed tiles, with a smooth or structured pad, subjected to intermediate intensity mechanical processing, with little removal of the material after firing to give the surface a smooth and slightly glazed finish, polished but not reflecting. / Surface résultant de la production d'un carreau pressé, par un tampon lisse ou structuré, soumis à un travail mécanique d'une intensité moyenne, avec une élimination minimale de matière après la cuisson, afin de donner à la surface une finition douce et légèrement satinée, polie mais non réfléchissante. / Die Oberfläche entsteht durch eine Fliesenpressung unter Verwendung eines glatten oder strukturierten Stempels. Die Fliese wird einer mittelschweren mechanischen Bearbeitung unterzogen, wobei im Anschluss an das Brennen eine minimale Materialmenge abgetragen wurde. Dies verleiht der Oberfläche ein weiches, leicht satinierendes, geschliffenes aber reflektionsfreies Finish. / Superficie que resulta de la producción de baldosa prensada, con tampón liso o estructurado, sometido a un proceso mecánico de intensidad intermedia, con mínima eliminación de materia, posterior a la cocción para dar a la superficie un acabado suave y levemente satinado, pulido pero no reflectante. / Поверхность, получаемая в результате производства прессованной плитки, с использованием гладкого или структурированного тампона, подверженная механической обработке после обжига средней интенсивности, с минимальным удалением материала, для придания поверхности мягкой, слегка сатиновой отделки, шлифованной, не отражающей свет.

Cannetè / Cannetè / Cannetè / Cannetè / Cannetè

Superficie risultante dalla produzione di piastrella pressata a tampone non liscio con rilievi geometrici regolari ad intensità crescente, senza lavorazioni successive alla cottura. / Surface resulting from the manufacturing of a tile pressed with a non-smooth pad featuring regular geometrical embossing with increasing intensity, with no further processing after firing. / Surface résultant de la production d'un carreau pressé par tampon non lisse, avec reliefs géométriques d'intensité croissante, sans usinage après la cuisson. / Die Oberflächen sind das Ergebnis des Produktionsverfahrens der Fliesenpressung unter Verwendung eines unglatten Stempels mit gleichmäßigen geometrischen Reliefs ohne eine Weiterbearbeitung nach dem Brennen. / Superficie resultante de la producción de azulejos prensados con tampones texturados, con relieves geométricos regulares de intensidad creciente, sin elaboraciones posteriores a la cocción. / Поверхность получается в результате прессования в пресс-форме не с гладкой внутренней поверхностью, а с постепенно увеличивающимися по размеру выпуклостями с регулярным геометрическим рисунком, без последующей обработке во время обжига.

Patiné - Adouci

Superficie ottenuta dopo la cottura sottoponendo a spazzolatura meccanica di intensità intermedia lastre non smaltate con tampone liscio o ondulato. La superficie finale è morbida, lievemente satinata, non riflettente. / Surface obtained after firing subjecting unglazed slabs to intermediate intensity mechanical brushing with smooth or wavy die. The final surface is soft, slightly satin-finished, non reflective. Surface obtenue après cuisson, en soumettant des dalles non émaillées à un broyage mécanique de moyenne intensité au moyen d'un tampon lisse ou ondulé. La surface finale est douce, légèrement satinée, non réfléchissante. / Oberfläche, die nach dem Brand erhalten wurde, indem nicht emaillierte Platten mit glatter oder wellförmiger Kachelunterlage mit einer Serie von Reibwerkzeugen mit kleiner werdender Struktur einer mechanischen Bürstung mit mittlerer Stärke unterzogen wurden. Die fertige Oberfläche ist weich, leicht satiniert, nicht reflektierend. / Superficie obtenida después de la cocción sometiendo las losas no esmaltadas a un procedimiento de cepillado mecánico de intensidad intermedia con molde liso u ondulado. La superficie final es suave, ligeramente satinada, no reflectante. / Эта поверхность получена после обжига, подвергая механической щеточной обработке средней интенсивности неглазурованные плиты, используя гладкий или волнистый тампон. Готовая поверхность является мягкой, слегка сатирированной, не отражающей.

Tabella Imballi

PACKAGE TABLE - TABLEAU DE EMBALLAGES - TABELLE FORMATE - TABLA DE LOS EMBALAJES - Таблица упаковок

	scatola - box			pallet		
	pz	mq	kg	box	mq	kg

imballi per scatola
packages for boxes
emballages pour boîte
verpackungen für schachteln
embalajes para cajas
Упаковки на коробку

imballi per pallet
packages for pallets
emballages pour palette
verpackungen für paletts
embalajes para paletas
Упаковки на поддон

Tabella gruppi di prezzo

TABLE OF PRICE RANGES - TABLEAU GROUPE DES PRIX - TABELLE PREISGRUPPEN - TABLA DE GRUPO DE PRECIOS - Таблица ценовых групп

Descrizione simboli / Description of symbols / Description symboles / Zeichenerklärung / Descripción de los símbolos / Описание символов			
<p>■</p> <p>PREZZO PER MATERIALE GESTITO A METRO QUADRO Price for materials managed per square metre. Prix pour matériau géré au mètre carré Materialpreis pro Quadratmeter Precio del material por metro cuadrado Цена за материал, реализуемый квадратными метрами</p>	<p>▲</p> <p>*PREZZO PER MATERIALE GESTITO A PEZZO Price for materials managed per piece Prix pour matériau géré à la pièce Materialpreis pro Stück Precio del material por pieza Цена за материал, реализуемый поштучно</p>	<p>●</p> <p>PREZZO PER MATERIALE GESTITO A NUMERO/COMPOSIZIONE Price for materials managed per number/composition Prix pour matériau géré à nombre/composition Materialpreis pro Anzahl/zusammenstellung Precio del material por número/composición Цена за материал, реализуемый комплектами/ композициями</p>	<p>◆</p> <p>PREZZO PER MATERIALE GESTITO A METRO LINEARE Price for materials managed lm Prix pour matériau géré à mètre linéaire Materialpreis pro Lfm Precio del material por ml Цена за композицию</p>
<p>*costo al pezzo, vendita a scatola completa price per piece, sold by full boxes only • prix à la pièce, vente à la boîte complète • Stückpreis bei voller Kartonabnahme • precio à la pieza, venta à caja completata • Стоимость одной штуки, продаются целыми коробками</p>			



ARDOISE

gres fine porcellanato
fine porcelain stoneware
grès cérame fin
feinsteinzeug-kollektionen
gres porcelánico fino
фарфоровый керамогранит





ARDOISE

Una precisa dichiarazione estetica caratterizza la serie **Ardoise**: dare significato all'ambiente nascondendo il progetto, per essere percepita come semplice emozione. I colori e i diversi formati diventano elementi percettivi e comunicativi che aiutano a riscoprire il posto dell'anima, ad esaltare lo spessore e il valore di ogni architettura. La delicatezza cromatica porta alla mente un forte senso di libertà, aria, luce e spazi aperti, ricettivi alla creatività dell'abitare luoghi e culture in continuo mutamento. Lo spazio si adatta ai nostri desideri e Rex riesce a rendere contemporanea una materia senza tempo donandole una nuova vita.

The character of the **Ardoise** range is contained in a precise aesthetic statement: to give meaning to the environment by hiding the design, so that it is perceived simply in terms of the emotions. The colours and the various sizes are clear, communicative elements that help to rediscover an emotional dimension and enhance the importance and the value of any architecture. The delicate colours bring to mind a strong sense of freedom, air, light and open spaces, receptive to the creativity of living in places and cultures that are continually changing. The space adapts itself to our desires and Rex manages to make a timeless material modern, by giving it new life.

C'est une déclaration esthétique bien précise qui caractérise la série **Ardoise**: donner un sens à l'ambiance en cachant le projet, pour une perception de simple émotion. Les couleurs et les différents formats deviennent des éléments perceptifs et communicatifs, qui nous aident à redécouvrir notre âme, à exalter l'importance et la valeur de chaque architecture. La délicatesse chromatique offre à l'esprit une grande sensation de liberté, d'air, de lumière et de larges espaces, réceptifs à la créativité pour vivre des lieux et des cultures en constante évolution. L'espace s'adapte à nos désirs et Rex rend son actualité à une matière sans âge en lui offrant une nouvelle vie.

Eine präzise ästhetische Erklärung kennzeichnet **Ardoise**: der Umwelt Bedeutung schenken und das Projekt verbergen, damit es nur als einfache Emotion wahrgenommen wird. Die Farben und verschiedenen Formate werden zu Wahrnehmungs- und Kommunikationselementen, die uns dazu verhelfen, den Ort der Seele wieder zu entdecken und die Bedeutung und den Wert jeder Architektur hervorzuheben. Die chromatische Feinheit schenkt unserem Geist ein starkes Gefühl von Freiheit, Luft, Licht und Freiräume und macht uns empfängsbereit für die Kreativität des Wohnens an Orten und in Kulturen, die sich ständig verändern. Der Raum passt sich unseren Wünschen an und Rex gelingt es, eine zeitlose Materie modern zu gestalten und ihr ein neues Leben zu verleihen.

La serie **Ardoise** se caracteriza por una precisa declaración estética: dar significado al ambiente ocultando el proyecto, para ser concebida como una simple emoción. Los colores y los diferentes formatos se convierten en elementos perceptivos y comunicativos que ayudan a redescubrir el sitio del alma, a exaltar la dimensión y el valor de cada arquitectura. La delicadeza cromática hace recordar un fuerte sentido de libertad, aire, luz y espacios abiertos, que reciben la creatividad de habitar lugares y culturas que cambian continuamente. El espacio se adapta a nuestros deseos y Rex logra convertir en contemporánea una materia atemporal, revitalizándola.

Коллекцию **Ardoise** характеризует стиль, четко определяющий ее предназначение: наделить особым смыслом сам интерьер, не акцентируя внимания на деталях, из предмета перевоплотиться в эмоцию. Цвета и различные форматы превращаются в средства коммуникации, которые помогают по-новому раскрыть «душу» каждого интерьера, подчеркнуть его глубину и ценность. Мягкая цветовая гамма вызывает стойкие ассоциации со свободой, воздухом, светом, с открытым пространством, с местами, где хочется жить и творить, с постоянно меняющимися культурами. И вот уже окружающее пространство подчиняется нашим желаниям, ведь Rex сумел подарить новую жизнь матери, не имеющей возраста, сумел превратить ее в современный элемент.

ARDOISE

BLANC



IVOIRE



V3

R10
(matte)

R11
(grip)

CLASSE B
(grip)

DCOF >
0,42 Wet

10 mm 3/8" ↑↓



V3

R9
(matte)



DCOF >
0,42 Wet

6 mm 1/4" ↑↓

FLORIM OVERSIZE
magnUm

GRES FINE PORCELLANATO

FINE PORCELAIN STONEWARE/GRES CERAME FIN/FEINSTEINZEUG-KOLLEKTIONEN/GRES PORCELANICO FINO/ФАРФОРОВЫЙ КЕРАМОГРАНИТ
SQUADRATO - SQUARED - EQUARRI - REKTIFIZIERT - ESCUADRADO - КАЛИБРОВАННАЯ*

				20x80* 7 ^{7/8"} x31 ^{1/2"}	30,4x60,8 12"x23 ^{7/8"}	40x80* 15 ^{3/4"} x31 ^{1/2"}	60x120* 23 ^{3/8"} x47 ^{1/4"}	80x80* 31 ^{1/2"} x31 ^{1/2"}
ARDOISE		BLANC	MATTE	738885 ■ FL-09900	738705 ■ FL-06000	738717 ■ FL-07700	738711 ■ FL-09900	738644 ■ FL-09300
			GRIP	738785 ■ FL-09900	-	738723 ■ FL-07700	-	738650 ■ FL-09300
		IVOIRE	MATTE	738886 ■ FL-09900	738706 ■ FL-06000	738718 ■ FL-07700	738712 ■ FL-09900	738645 ■ FL-09300
			GRIP	738786 ■ FL-09900	-	738725 ■ FL-07700	-	738651 ■ FL-09300
				120x240* 47 ^{1/4"} x94 ^{1/2"}	120x120* 47 ^{1/4"} x47 ^{1/4"}	60x120* 23 ^{3/8"} x47 ^{1/4"}		
ARDOISE		BLANC	MATTE	745920 ■ FL-11300	745924 ■ FL-09700	757828 ■ FL-09100		

ECRU



GRIS



V3

R10
(matte)

R11
(grip)

CLASSE B
(grip)

DCOF >
0,42 Wet

10 mm 3/8" ↑↓



V3

R9
(matte)

DCOF >
0,42 Wet

6 mm 1/4" ↑↓

FLOORM OVERSIZE
magnUm

GRES FINE PORCELLANATO

FINE PORCELAIN STONEWARE/GRES CERAME FIN/FEINSTEINZEUG-KOLLEKTIONEN/GRES PORCELANICO FINO/ФАРФОРОВЫЙ КЕРАМОГРАНИТ

SQUADRATO - SQUARED - EQUARRI - REKTIFIZIERT - ESCUADRADO - КАЛИБРОВАННАЯ*

10 mm 3/8" ↑↓		COLOR	SURFACE	20x80* 7 ^{7/8"} x31 ^{1/2"}	30,4x60,8 12"x23 ^{7/8"}	40x80* 15 ^{3/4"} x31 ^{1/2"}	60x120* 23 ^{5/8"} x47 ^{1/4"}	80x80* 31 ^{1/2"} x31 ^{1/2"}
ARDOISE		ECRU	MATTE	738887 ■ FL-09900	738707 ■ FL-06000	738719 ■ FL-07700	738713 ■ FL-09900	738646 ■ FL-09300
			GRIP	738787 ■ FL-09900	-	738726 ■ FL-07700	-	738652 ■ FL-09300
		GRIS	MATTE	738888 ■ FL-09900	738708 ■ FL-06000	738720 ■ FL-07700	738714 ■ FL-09900	738647 ■ FL-09300
			GRIP	738788 ■ FL-09900	-	738727 ■ FL-07700	-	738653 ■ FL-09300

6 mm 1/4" ↑↓		COLOR	SURFACE	120x240* 47 ^{1/4"} x94 ^{1/2"}	120x120* 47 ^{1/4"} x47 ^{1/4"}	60x120* 23 ^{5/8"} x47 ^{1/4"}
ARDOISE		ECRU	MATTE	745921 ■ FL-11300	745925 ■ FL-09700	757829 ■ FL-09100
		GRIS	MATTE	745922 ■ FL-11300	745926 ■ FL-09700	757830 ■ FL-09100

ARDOISE

PLOMBE



NOIR



V3

R10
(matte)

R11
(grip)

CLASSE B
(grip)

DCOF >
0,42 Wet

10 mm 3/8" ↑↓



V3

R9
(matte)

DCOF >
0,42 Wet

6 mm 1/4" ↑↓



FLOREM OVERSIZE
magnum

GRES FINE PORCELLANATO





FINE PORCELAIN STONEWARE/GRES CERAME FIN/FEINSTEINZEUG-KOLLEKTIONEN/GRES PORCELANICO FINO/ФАРФОРОВЫЙ КЕРАМОГРАНИТ
SQUADRATO - SQUARED - EQUARRI - REKTIFIZIERT - ESCUADRADO - КАЛИБРОВАННАЯ*

10 mm 3/8" ↑↓	COLOR	SURFACE	20x80* 7 ^{7/8"} x31 ^{1/2"}	30,4x60,8 12"x23 ^{7/8"}	40x80* 15 ^{3/4"} x31 ^{1/2"}	60x120* 23 ^{3/8"} x47 ^{1/4"}	80x80* 31 ^{1/2"} x31 ^{1/2"}
ARDOISE	PLOMBE	MATTE	738889 ■ FL-09900	738709 ■ FL-06000	738721 ■ FL-07700	738715 ■ FL-09900	738648 ■ FL-09300
		GRIP	738789 ■ FL-09900	-	738728 ■ FL-07700	-	738654 ■ FL-09300
	NOIR	MATTE	738890 ■ FL-09900	738710 ■ FL-06000	738722 ■ FL-07700	738716 ■ FL-09900	738649 ■ FL-09300
		GRIP	738790 ■ FL-09900	-	738729 ■ FL-07700	-	738655 ■ FL-09300

6 mm 1/4" ↑↓	COLOR	SURFACE	120x240* 47 ^{1/4"} x94 ^{1/2"}	120x120* 47 ^{1/4"} x47 ^{1/4"}	60x120* 23 ^{3/8"} x47 ^{1/4"}
ARDOISE	NOIR	MATTE	745923 ■ FL-11300	745927 ■ FL-09700	757831 ■ FL-09100

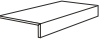
10 mm 3/8" ↑↓			30x30 11 ^{4/5"} x11 ^{4/5"}	21x40 8 ^{1/4"} x15 ^{3/4"}	30x30 11 ^{4/5"} x11 ^{4/5"}
	COLOR		 mosaico grip tessere 5x5	 modulo listello sfalsato	 modulo muretto 3D pz/box 6
ARDOISE	BLANC	739356 ■ FL-15600	739362 ■ FL-21000	739368 ▲ FL-03800	
	IVOIRE	739357 ■ FL-15600	739363 ■ FL-21000	739369 ▲ FL-03800	
	ECRU	739358 ■ FL-15600	739364 ■ FL-21000	739370 ▲ FL-03800	
	GRIS	739360 ■ FL-15600	739366 ■ FL-21000	739372 ▲ FL-03800	
	PLOMBE	739359 ■ FL-15600	739365 ■ FL-21000	739371 ▲ FL-03800	
	NOIR	739361 ■ FL-15600	739367 ■ FL-21000	739373 ▲ FL-03800	







PEZZI SPECIALI/SPECIAL TRIMS/PIÈCES SPÉCIALES/FORMSTÜCKE/PIEZAS ESPECIALES/Специальные изделия

10 mm 3/8" ↑↓			4,6x60 1 ^{4/5"} x23 ^{5/8"}	15x30x4 6"x11 ^{4/5"} x1 ^{4/7"}	33x120x3 13"x47 ^{1/4"} x1 ^{1/8"}	33x120x3 13"x47 ^{1/4"} x1 ^{1/8"}	33x120x3 13"x47 ^{1/4"} x1 ^{1/8"}	33x120x3 13"x47 ^{1/4"} x1 ^{1/8"}
	COLOR		 battiscopa	 elemento elle grip pz/box 6	 gradino pz/box 2	 angolo gradino dx pz/box 2	 angolo gradino sx pz/box 2	 angolo gradino dx/sx pz/box 1
ARDOISE	BLANC	745427 ◆ FL-01600	739350 ▲ FL-02000	739319 ▲ FL-20400	739325 ▲ FL-31100	739331 ▲ FL-31100	739337 ▲ FL-42900	
	IVOIRE	745430 ◆ FL-01600	739351 ▲ FL-02000	739320 ▲ FL-20400	739326 ▲ FL-31100	739332 ▲ FL-31100	739338 ▲ FL-42900	
	ECRU	745428 ◆ FL-01600	739352 ▲ FL-02000	739321 ▲ FL-20400	739327 ▲ FL-31100	739333 ▲ FL-31100	739339 ▲ FL-42900	
	GRIS	745429 ◆ FL-01600	739354 ▲ FL-02000	739323 ▲ FL-20400	739329 ▲ FL-31100	739335 ▲ FL-31100	739341 ▲ FL-42900	
	PLOMBE	745432 ◆ FL-01600	739353 ▲ FL-02000	739322 ▲ FL-20400	739328 ▲ FL-31100	739334 ▲ FL-31100	739340 ▲ FL-42900	
	NOIR	745431 ◆ FL-01600	739355 ▲ FL-02000	739324 ▲ FL-20400	739330 ▲ FL-31100	739336 ▲ FL-31100	739342 ▲ FL-42900	

ARDOISE	scatola - box			pallet		
	pz	m ²	kg	box	m ²	kg
20x80	6	0,96	21,40	48	46,08	1050
30,4x60,8	6	1,11	26,00	40	44,40	1060
40x80	3	0,96	22,00	56	53,76	1260
60x120	2	1,44	33,40	30	43,20	1030
80x80	2	1,28	29,80	40	51,20	1220
21x40 mod. list. sfal.	5	0,42	9,80	40	16,80	420
30x30 mod. muretto	6	0,54	12,00	24	12,96	310

ARDOISE	scatola - box			pallet		
	pz	ml	kg	box	m ²	kg
4,6x60 battiscopa	14	8,40	8,40	-	-	-

ARDOISE

6 mm 1/4"				30x30 11 ^{4/5"} x11 ^{4/5"}	30x30 11 ^{4/5"} x11 ^{4/5"}	30x30 11 ^{4/5"} x11 ^{4/5"}
	COLOR	SURFACE	 mosaico tessere 7,5x7,5 pz/box 11	 muretto tessere 7,5x15 pz/box 11	 mosaico tessere 1,5x3 pz/box 11	
	BLANC	MATTE	747759 ▲ FL-01800	747789 ▲ FL-01800	747812 ▲ FL-02700	
	ECRU	MATTE	747760 ▲ FL-01800	747790 ▲ FL-01800	747813 ▲ FL-02700	
ARDOISE 	GRIS	MATTE	747761 ▲ FL-01800	747791 ▲ FL-01800	747814 ▲ FL-02700	
	NOIR	MATTE	747762 ▲ FL-01800	747792 ▲ FL-01800	747815 ▲ FL-02700	

Nelle operazioni di posa a listoni sfalsati, si raccomanda sempre di fare in modo che il lato maggiore della piastrella termini a circa un terzo della lunghezza di quelle accanto (posa sfalsata "a 1/3"). - When installing staggered strips, we recommend that the tile's longer side should always end at about one-third of the length of the tiles next to it ("1/3" staggered installation) - Lors de la pose des listels décalés, il faut toujours faire en sorte que le côté le plus grand du carreau se trouve à environ 1/3 de la longueur des carreaux d'à côté (pose décalée "à 1/3"). - Beim Verlegen der Leisten in versetzter Form ist zu beachten, dass die höhere Seite der Fliese immer circa bei einem Drittel der Länge der sich daneben befindlichen Fliesen abschließt ("Um 1/3" versetzte Verlegung) - En las operaciones de colocación de listones escalonados, se recomienda hacerlo siempre de forma tal que el lado mayor del azulejo termine teniendo alrededor de un tercio de la longitud de los contiguos (colocación escalonada "a 1/3") - При укладке зигзагом следите за тем, чтобы более длинный край плиток заканчивался примерно на 1/3 длины соседних плиток (укладка зигзагом «1/3»)

Per un effetto ottimale della posa, florim suggerisce di mantenere 2 mm di fuga per pose monofornate e 3 mm per combinare formati misti. - For optimal installation results, florim recommends maintaining a joint of 2 mm (1/12") for single format installations and 3 mm (1/8") to combine mixed formats. - Pour réaliser une pose parfaite, florim suggère de maintenir 2 mm de joint pour la pose des monofornats, et 3 mm pour les combinaisons de formats mixtes. - Um einen optimalen Effekt beim Verlegen zu erzielen empfiehlt florim eine 2 mm Fuge bei einformatigen Verlegungen und 3 mm Fuge bei Formatkombinationen. Para lograr los máximos resultados en la posa del producto, florim aconseja 2 mm de junta en aplicaciones monofornato y 3 mm en combinaciones de formatos mixtos. **ДЛЯ ОПТИМАЛЬНОЙ УКЛАДКИ * FLORIM * РЕКОМЕНДУЕТ ВЫДЕРЖИВАТЬ ЗАЗОР 2 ММ ДЛЯ МОНОФОРМАТА И 3 ММ ПРИ СМЕШАННЫХ ФОРМАТАХ.**

In relazione alle differenti tecnologie produttive l'accostamento di prodotti con spessori diversi potrebbe presentare delle disomogeneità, se ne sconsiglia pertanto l'abbinamento. / Due to the different production technologies, contiguous installation of products with different thickness may give a non-homogeneous result. For this reason we do not recommend this option. / Vu que différentes technologies de production sont utilisées avec des épaisseurs différentes, des problèmes d'homogénéité pourraient se présenter, il est donc déconseillé de les poser ensemble. / Wegen unterschiedlicher Produktionstechnologien können die Fliesen mit verschiedenen Materialstärken optische Differenzen aufweisen. Von einem direkten Aneinanderlegen wird deshalb abgeraten. / Dadas las diferentes tecnologías productivas, la combinación de productos de diferentes espesores podría dar lugar a heterogeneidad, por lo que se desaconseja mezclarlas. / В связи с различием в технологиях производства, сочетание продукции разной толщины иногда может представлять неоднородность материала. Такие сочетания следует избегать.

FLORIM OVERSIZE
magnUm

120x240/120x120/60x120

Specifica Imballo pag.
Packaging specifications on page
Spécifications d'emballage à page
Verpackungsdetail Seite
Especificaciones de embalaje a la página
Информация об упаковке на стр.
200/201

Luxury design





ATMOSPHERES DE REX

gres fine porcellanato
fine porcelain stoneware
grès cérame fin
feinsteinzeug-kollektionen
gres porcelánico fino
фарфоровый керамогранит





ATMOSPHÈRES DE REX

Atmosphères de Rex è una collezione dal gusto ruvido ed elegante che reinterpreta in stile contemporaneo il lusso semplice ed informale della Pierre Bleue, una pietra sedimentaria originaria del Belgio che porta con sé un'energia profonda e coinvolgente. La sua particolare superficie, delicatamente eterogenea, e le tenui sfumature di colore raccontano una storia millenaria che risale ad un passato molto lontano, quando il territorio dell'odierno Belgio era bagnato da un mare ricco di formazioni coralline. Piccoli organismi e residui marini fossilizzati, come le conchiglie o i meravigliosi gigli di mare, si incorporano spontaneamente all'interno di queste rocce, creando un effetto estetico variegato e dal sapore antico.

Atmosphères de Rex is a collection with rough yet elegant taste offering a contemporary reinterpretation of the simple, informal luxury of Pierre Bleue, a sedimentary stone from Belgium with a profound, thrilling energy all its own. Its distinctive, delicately variegated surface and subtly graduated shades tell a story reaching back over the millennia to a very distant past, when the area that is now Belgium lay under a sea rich in coralline formations. Small creatures and fossilised marine residues, such as shells or the wonderful sea daffodil, were naturally incorporated in these rocks, creating a constantly changing aesthetic with an antique air.

Atmosphères de Rex est une collection au caractère brut et élégant qui réinterprète dans un style contemporain le luxe simple et informel de la Pierre Bleue, une pierre sédimentaire originaire de Belgique d'où émane une énergie profonde et captivante. Sa surface particulière, délicatement hétérogène, et ses subtiles nuances de couleurs racontent une histoire millénaire remontant à un passé très lointain, lorsque le territoire de l'actuelle Belgique était baigné par une mer riche en formations coralliennes. De petits organismes et résidus marins fossilisés, comme les coquillages ou les splendides Lis maritimes, s'amalgament Atmosphères de Rex est une collection au caractère brut et élégant qui réinterprète dans un style contemporain le luxe simple et informel de la Pierre Bleue, une pierre sédimentaire originaire de Belgique d'où émane une énergie profonde et captivante.

Die Kollektion **Atmosphères de Rex** besticht mit einer spröden Schönheit, die von der schlichten, luxuriösen Optik des Pierre Bleue inspiriert ist. Das in Belgien vorkommende Sedimentgestein ist auch unter dem Namen Blaue Hardsteen oder Blaustein bekannt und zeichnet sich durch eine intensive, prägnante Ausstrahlung aus. In seiner dezent strukturierten Oberfläche und seinen zarten Farbschattierungen klingt eine tausendjährige Geschichte, eine ferne Vergangenheit an, als ein korallenreiches Meer das heutige Gebiet von Belgien überzog. Fossile Kleinlebewesen und Meeresbewohner wie Muscheln und Seelilien, die unregelmäßig im Gestein vorkommen, sorgen für eine abwechslungsreiche, geschichtsträchtige Oberfläche.

Atmosphères de Rex es una colección de sabor rústico y elegante que reinterpreta con estilo contemporáneo el lujo simple e informal de la Pierre Bleue, una piedra sedimentaria original de Bélgica que encierra una energía profunda y envolvente. Su superficie distintiva, delicadamente heterogénea, y los tenues matices de color narran una historia milenaria que se remonta a un tiempo remoto, cuando la zona ocupada actualmente por Bélgica estaba cubierta por un mar rico en formaciones coralinas. Pequeños organismos y restos marinos fosilizados, tales como las conchas y los maravillosos lirios de mar, se integran espontáneamente en estas piedras y crean un efecto estético variado y de gusto antiguo.

Atmosphères de Rex - это коллекция в суровом и элегантном вкусе, пересматривающая в современном ключе простую и неформальную роскошь Pierre Bleue - бельгийской осадочной породы, наделенной глубокой и увлекающей энергией. Особенная, изысканно разнообразная поверхность этого камня и мягкие оттенки цвета рассказывают о тысячелетней истории очень далекого прошлого, когда территория современной Бельгии омывалась морем, богатым коралловыми образованиями. Мелкие организмы и морские окаменелости, такие как ракушки или же удивительные морские панкрации, были произвольно поглощены этими породами, создавая эстетику с пестрым эффектом в старинном вкусе.

ATMOSPHÈRES DE REX

LUMIÈRE - ADOUCI



OMBRE - ADOUCI

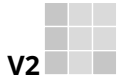

V2

R9



DCOF >
0,42 Wet

6 mm 1/4" ↑↓

FLORIM OVERSIZE
magnUm

GRES FINE PORCELLANATO

FINE PORCELAIN STONEWARE/GRES CERAME FIN/FEINSTEINZEUG-KOLLEKTIONEN/GRES PORCELANICO FINO/ФАРФОРОВЫЙ КЕРАМОГРАНИТ
SQUADRATO - SQUARED - EQUARRI - REKTIFIZIERT - ESCUADRADO - КАЛИБРОВАННАЯ

6 mm 1/4" ↑↓		COLOR	SURFACE	120x280 47 ^{1/4"} x110 ^{1/4"}	120x240 47 ^{1/4"} x94 ^{1/2"}	120x120 47 ^{1/4"} x47 ^{1/4"}	60x120 23 ^{5/8"} x47 ^{1/4"}
ATMOSPHÈRES DE REX		LUMIÈRE	ADOUCI	773417 ■ FL-12400	773422 ■ FL-11300	773425 ■ FL-09700	773427 ■ FL-09100
		OMBRE	ADOUCI	773409 ■ FL-12400	773414 ■ FL-11300	773415 ■ FL-09700	773416 ■ FL-09100

LUMIÈRE - CANNETÉ

OMBRE - CANNETÉ

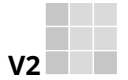
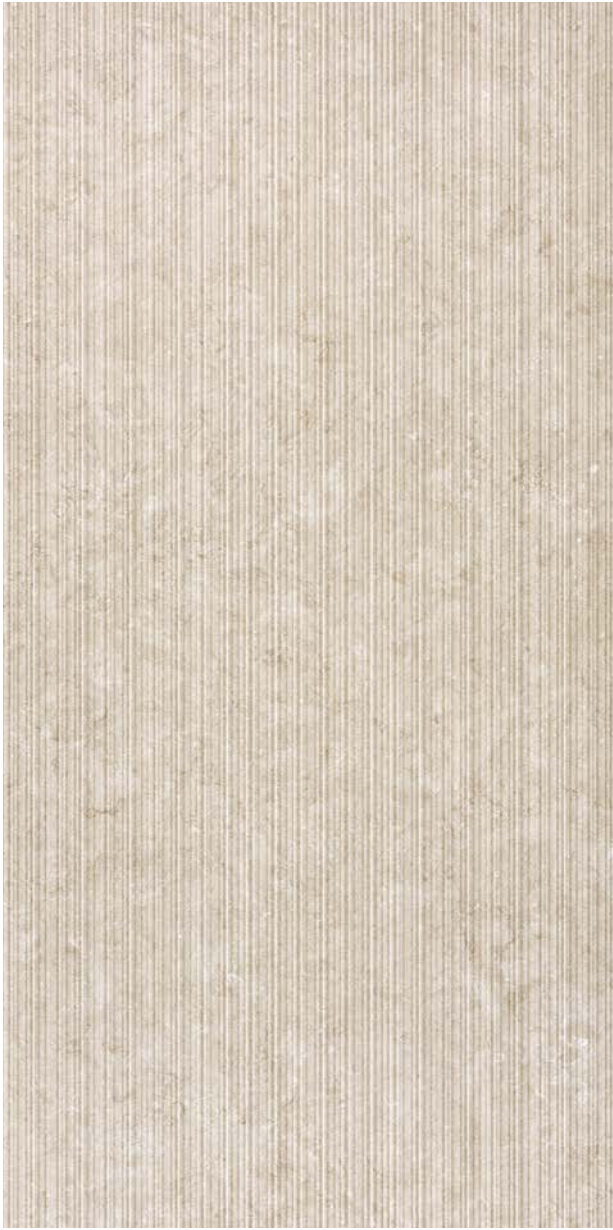

10 mm 3/8" ↑↓

GRES FINE PORCELLANATO

FINE PORCELAIN STONEWARE/GRES CERAME FIN/FEINSTEINZEUG-KOLLEKTIONEN/GRES PORCELANICO FINO/ФАРФОРОВЫЙ КЕРАМОГРАНИТ
SQUADRATO - SQUARED - EQUARRI - REKTIFIZIERT - ESCUADRADO - КАЛИБРОВАННАЯ

10 mm 3/8" ↑↓

	COLOR	SURFACE	60x120 23 ^{5/8"} x47 ^{1/4"}	
ATMOSPHÈRES DE REX		LUMIÈRE	CANNETÉ	773392 ■ FL-10300
		OMBRE	CANNETÉ	773393 ■ FL-10300

La superficie CANNETÉ è da utilizzare solo a rivestimento. / The CANNETÉ' surface is to be used as coating only. / La surface CANNETÉ' est à utiliser uniquement comme revêtement.
Die glänzende CANNETÉ' ist nur als Wandfliesen zu verwenden. / La superficie CANNETÉ' se debe usar sólo con revestimiento. / CANNETÉ' поверхность должна использоваться только для облицовки.

ATMOSPHÈRES DE REX

HARMONIE - SABLÉ



HARMONIE - PATINÉ



V3
R10
(sablé)

R11
(structuré)

CLASSE B
(sablé)
(structuré)

DCOF>
0,42 Wet
(sablé)
(patiné)
(structuré)

PTV>36 wet
slider 4S
(structuré)

10 mm 3/8" ↓

GRES FINE PORCELLANATO

FINE PORCELAIN STONEWARE/GRES CERAME FIN/FEINSTEINZEUG-KOLLEKTIONEN/GRES PORCELANICO FINO/ФАРФОРОВЫЙ КЕРАМОГРАНИТ

SQUADRATO - SQUARED - EQUARRI - REKTIFIZIERT - ESCUADRADO - КАЛИБРОВАННАЯ

10 mm 3/8" ↓	COLOR	SURFACE	60x120 23 ^{5/8"} x47 ^{1/4"}	80x80 31 ^{1/2"} x31 ^{1/2"}	40x80 15 ^{3/4"} x31 ^{1/2"}	60x60 23 ^{5/8"} x23 ^{5/8"}	30x60 11 ^{4/8"} x23 ^{5/8"}
		SABLÉ (NATURALE)	773341 ■ FL-09600	773377 ■ FL-09300	773382 ■ FL-06900	773356 ■ FL-06900	773362 ■ FL-05900
ATMOSPHÈRES DE REX	HARMONIE	PATINÉ (SMOOTH)	773336 ■ FL-09900	773367 ■ FL-09600	773372 ■ FL-07300	773346 ■ FL-07300	773351 ■ FL-06200
		STRUCTURÉ (STUTTURATO)	773387 ■ FL-09600	-	-	-	-

AUORE - SABLÉ



AUORE - PATINÉ



R10
(sablé)

R11
(structuré)

CLASSE B
(sablé)
(structuré)

DCOF>
0,42 Wet
(sablé)
(patiné)
(structuré)

PTV>36 wet
slider 4S
(structuré)

10 mm 3/8" ↓

GRES FINE PORCELLANATO

FINE PORCELAIN STONEWARE/GRES CERAME FIN/FEINSTEINZEUG-KOLLEKTIONEN/GRES PORCELANICO FINO/ФАРФОРОВЫЙ КЕРАМОГРАНИТ
SQUADRATO - SQUARED - EQUARRI - REKTIFIZIERT - ESCUADRADO - КАЛИБРОВАННАЯ

10 mm 3/8" ↓	COLOR	SURFACE	60x120 23 ^{5/8"} x47 ^{1/4"}	80x80 31 ^{1/2"} x31 ^{1/2"}	40x80 15 ^{3/4"} x31 ^{1/2"}	60x60 23 ^{5/8"} x23 ^{5/8"}	30x60 11 ^{4/8"} x23 ^{5/8"}
		SABLÉ (NATURALE)	773342 ■ FL-09600	773378 ■ FL-09300	773383 ■ FL-06900	773357 ■ FL-06900	773363 ■ FL-05900
ATMOSPHERES DE REX	AUORE	PATINÉ (SMOOTH)	773337 ■ FL-09900	773368 ■ FL-09600	773373 ■ FL-07300	773347 ■ FL-07300	773352 ■ FL-06200
		STRUCTURÉ (STUTTURATO)	773388 ■ FL-09600	-	-	-	-

ATMOSPHÈRES DE REX

DÉSIR - SABLÉ



DÉSIR - PATINÉ



R10
(sablé)

R11
(structuré)

CLASSE B
(sablé)
(structuré)

DCOF>
0,42 Wet
(sablé)
(patiné)
(structuré)

PTV>36 wet
slider 4S
(structuré)

10 mm 3/8" ↓↑

GRES FINE PORCELLANATO

FINE PORCELAIN STONEWARE/GRES CERAME FIN/FEINSTEINZEUG-KOLLEKTIONEN/GRES PORCELANICO FINO/ФАРФОРОВЫЙ КЕРАМОГРАНИТ
SQUADRATO - SQUARED - EQUARRI - REKTIFIZIERT - ESCUADRADO - КАЛИБРОВАННАЯ

10 mm 3/8" ↓↑	COLOR	SURFACE	60x120 23 ^{5/8"} x47 ^{1/4"}	80x80 31 ^{1/2"} x31 ^{1/2"}	40x80 15 ^{3/4"} x31 ^{1/2"}	60x60 23 ^{5/8"} x23 ^{5/8"}	30x60 11 ^{4/8"} x23 ^{5/8"}
		SABLÉ (NATURALE)	773344 ■ FL-09600	773380 ■ FL-09300	773385 ■ FL-06900	773359 ■ FL-06900	773365 ■ FL-05900
	DÉSIR	PATINÉ (SMOOTH)	773339 ■ FL-09900	773370 ■ FL-09600	773375 ■ FL-07300	773349 ■ FL-07300	773354 ■ FL-06200
		STRUCTURÉ (STUTTURATO)	773390 ■ FL-09600	-	-	-	-

**ATMOSPHÈRES
DE REX**



CHARME - SABLÉ



CHARME - PATINÉ



V3

R10
(sablé)

R11
(structuré)

CLASSE B
(sablé)
(structuré)

DCOF>
0,42 Wet
(sablé)
(patiné)
(structuré)

PTV>36 wet
slider 4S
(structuré)

10 mm 3/8" ↓

GRES FINE PORCELLANATO

FINE PORCELAIN STONEWARE/GRES CERAME FIN/FEINSTEINZEUG-KOLLEKTIONEN/GRES PORCELANICO FINO/ФАРФОРОВЫЙ КЕРАМОГРАНИТ
SQUADRATO - SQUARED - EQUARRI - REKTIFIZIERT - ESCUADRADO - КАЛИБРОВАННАЯ

10 mm 3/8" ↓	COLOR	SURFACE	60x120 23 ^{5/8"} x47 ^{11/16"}	80x80 31 ^{1/2"} x31 ^{1/2"}	40x80 15 ^{3/16"} x31 ^{1/2"}	60x60 23 ^{5/8"} x23 ^{5/8"}	30x60 11 ^{4/5"} x23 ^{5/8"}
		SABLÉ (NATURALE)	773343 ■ FL-09600	773379 ■ FL-09300	773384 ■ FL-06900	773358 ■ FL-06900	773364 ■ FL-05900
ATMOSPHÈRES DE REX	CHARME	PATINÉ (SMOOTH)	773338 ■ FL-09900	773369 ■ FL-09600	773374 ■ FL-07300	773348 ■ FL-07300	773353 ■ FL-06200
		STRUCTURÉ (STUTTURATO)	773389 ■ FL-09600	-	-	-	-

ATMOSPHÈRES DE REX

MYSTÈRE - SABLÉ



MYSTÈRE - PATINÉ



V3
R10
(sablé)

R11
(structuré)

CLASSE B
(sablé)
(structuré)

DCOF>
0,42 Wet
(sablé)
(patiné)
(structuré)

PTV>36 wet
slider 4S
(structuré)

10 mm 3/8" ↓↑

GRES FINE PORCELLANATO

FINE PORCELAIN STONEWARE/GRES CERAME FIN/FEINSTEINZEUG-KOLLEKTIONEN/GRES PORCELANICO FINO/ФАРФОРОВЫЙ КЕРАМОГРАНИТ
SQUADRATO - SQUARED - EQUARRI - REKTIFIZIERT - ESCUADRADO - КАЛИБРОВАННАЯ

10 mm 3/8" ↓↑	COLOR	SURFACE	60x120 23 ^{5/8"} x47 ^{1/4"}	80x80 31 ^{1/2"} x31 ^{1/2"}	40x80 15 ^{3/4"} x31 ^{1/2"}	60x60 23 ^{5/8"} x23 ^{5/8"}	30x60 11 ^{4/8"} x23 ^{5/8"}
		SABLÉ (NATURALE)	773345 ■ FL-09600	773381 ■ FL-09300	773386 ■ FL-06900	773360 ■ FL-06900	773366 ■ FL-05900
ATMOSPHÈRES DE REX	MYSTÈRE	PATINÉ (SMOOTH)	773340 ■ FL-09900	773371 ■ FL-09600	773376 ■ FL-07300	773350 ■ FL-07300	773355 ■ FL-06200
		STRUCTURÉ (STUTTURATO)	773391 ■ FL-09600	-	-	-	-



ATMOSPHERES DE REX OUTDOOR

Vantaggi tecnici - Technical advantages - Avantages techniques Technische Vorteile - Ventajas técnicas - Технические преимущества

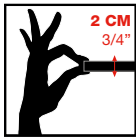

- Lastra monolitica compatta di spessore 2 cm squadrata e rettificata
- Compact monolithic slab 2 cm thick squared and rectified
- Dalle monolithique compacte de 2 cm d'épaisseur, équaree et rectifiée
- Kompakte monolithische Platte, 2 cm dick, rechteckig und scharfkantig geschliffen
- Losa monolítica compacta de 2 cm de espesor, escuadrada y rectificada.
- Монолитная плотная плита толщиной 2 см, с обрезанными и выровненными кромками

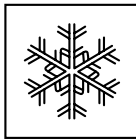

- INGELIVO
- FROST RESISTANT
- INGÉLIF
- FROSTBESTÄNDIG
- RESISTENTE A LA HELADA
- МОРОЗОСТОЙКАЯ

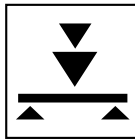

- ELEVATA RESISTENZA AI CARICHI STATICI
- HIGH STATIC LOAD RESISTANCE
- RÉSISTANCE ÉLEVÉE AUX CHARGES STATIQUES
- HOHE STATISCHE BELASTBARKEIT
- ELEVADA RESISTENCIA A LAS CARGAS ESTÁTICAS
- ВЫДЕРЖИВАЕТ БОЛЬШИЕ СТАТИЧЕСКИЕ НАГРУЗКИ

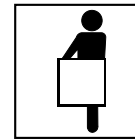

- FACILE DA POSARE
- EASY TO INSTALL
- FACILE À POSER
- VERLEGELEICHT
- FÁCIL DE COLOCAR
- ЛЕГКО УКЛАДЫВАЕТСЯ



- ANTISCIVOLO R11
- ANTI SLIP R11
- ANTIDÉRAPANT R11
- RUTSCHFEST R11
- ANTIDESLIZANTE R11
- НЕСКОЛЬЗКАЯ - R11

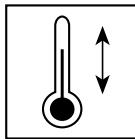

- RESISTENTE AGLI SBALZI TERMICI
- THERMAL SHOCK RESISTANT
- RÉSISTANT AUX ÉCARTS THERMIQUES
- TEMPERATURWECHSELBESTÄNDIG
- RESISTENTE A LAS OSCILACIONES TÉRMICAS
- СТОЙКАЯ К ТЕПЛОВЫМ ПЕРЕПАДАМ



- FACILE DA PULIRE
- EASY TO CLEAN
- FACILE À NETTOYER
- REINIGUNGSLEICHT
- FÁCIL DE LIMPIAR
- ЛЕГКО ЧИСТИТСЯ

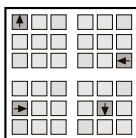

- RIMOVIBILE E RIUTILIZZABILE
- REMOVABLE AND REUSABLE
- DÉMONTABLE ET RÉUTILISABLE
- ENTFERNBAR UND WIEDERVERWENDBAR
- DESMONTABLE Y REUTILIZABLE
- МОЖЕТ СНИМАТЬСЯ И ПОВТОРНО ИСПОЛЬЗОВАТЬСЯ



- INATTACCABILE DA AGENTI CHIMICI E MUFFE
- IMPERVIOUS TO ATTACK BY CHEMICALS OR MOULD
- RÉSISTANT AUX AGENTS CHIMIQUES ET AUX MOISSISSURES
- UNANGREIFBAR DURCH CHEMISCHE STOFFE UND SCHIMMEL
- RESISTENTE A LOS AGENTES QUÍMICOS Y A LOS MOHOS
- НЕ ПОДВЕРГАЕТСЯ ВОЗДЕЙСТВИЮ ХИМИЧЕСКИХ ВЕЩЕСТВ И ПЛЕСЕНИ

Applicazioni - Applications - Applications - Verlegung - Aplicaciones - Применения

- Posa diretta su erba
- Direct installation on grass
- Pose direct sur de l'herbe
- Verlegung direkt auf Rasen
- Colocación directa sobre hierba
- Прямая укладка на траву

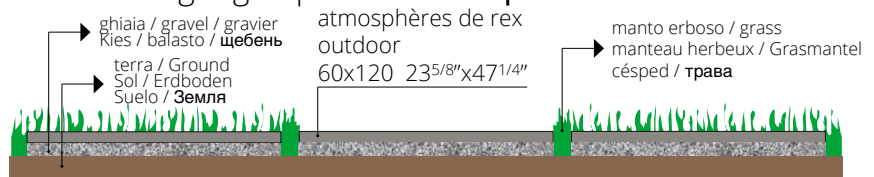

- Posa diretta su ghiaia
- Direct installation over gravel
- Pose direct sur du gravier
- Verlegung direkt auf Kies
- Colocación directa sobre grava
- Прямая укладка на гальку

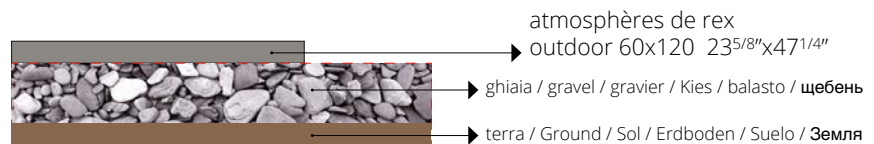

- Posa su massetto cementizio
- Installation on sand-cement screed
- Pose sur chape ciment
- Verlegung auf Zement-Unterbetonblock
- Colocación sobre contrapiso de hormigón
- Укладка на цементную стяжку

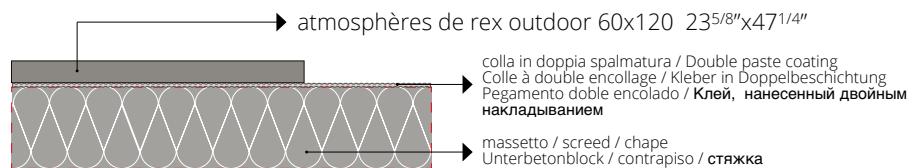

- Posa su piedini fissi o regolabili
- Installation on fixed or adjustable feet
- Pose sur pieds fixes ou réglables
- Verlegung auf feststehende oder regulierbare FüÙe
- Colocación sobre pies fijos o regulables
- Укладка на фиксированных или регулируемых ножках

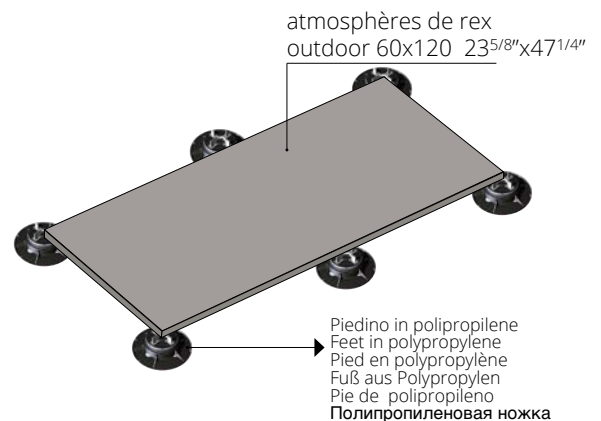

Per le specifiche di utilizzo dei sistemi sopraelevati vedi il sito florim.com
For the specifics on use of raised systems visit the site florim.com
Pour les caractéristiques d'utilisation des systèmes surélevés, voir le site florim.com
Für die Nutzungsbedingungen der Doppelbodensysteme siehe Webseite florim.com
Para las especificaciones de empleo de los sistemas sobreelevados consulte el sitio web florim.com
Технические характеристики систем фальшполов см. на сайте florim.com

Le lastre ceramiche sono sottoposte a un trattamento di compattazione termica che assicura resistenza e durata nel tempo. Il bassissimo assorbimento d'acqua rende perciò il materiale ingelivo. Ciò può comportare ristagni d'acqua superficiali anche per materiale installato a regola d'arte. / Ceramic tiles undergo a compacting thermal treatment that ensures resistance and durability. The low level of water absorption makes the slabs frost resistant. This could result in superficial water stagnations even if materials are installed in a workmanlike manner. / Les carreaux de céramique subissent un traitement thermique de compactage qui assure résistance et durabilité. Le bas niveau d'absorption d'eau rend les dalles résistant au gel. Il pourrait en résulter des stagnations d'eau superficielles, même si les dalles ont été installées dans les règles de l'art. / Die Keramikplatten werden einer thermischen Verdichtung unterzogen, welche die Widerstandsfähigkeit und Langlebigkeit sichert. Die extrem niedrige Wasseraufnahme macht das Material frostsicher. Die hohe Materialdichte kann, auch bei einer perfekten Verlegung, eine längere Abtrocknungszeit von angestauntem Wasser zur Folge haben. / Las baldosas cerámicas se someten a un tratamiento de compactación térmica que asegura resistencia y durabilidad. La baja absorción de agua hace que las baldosas resistan al hielo. Esto podría resultar en estancamientos superficiales de agua, incluso si los materiales están instalados según las reglas del arte. / Керамическая плитка подвергается термическому уплотнению, что обеспечивает ей прочность и износостойкость. За счёт очень низкого водопоглощения она не промерзает, при этом даже при правильной укладке возможны застои воды на поверхности плитки.

LUMIÈRE



OMBRE



R11
CLASSE
A+B
(structuré)
PTV>36 wet
slider 4S



DCOF>
0,42 Wet

20 mm 3/4" ↑↓

GRES FINE PORCELLANATO

FINE PORCELAIN STONEWARE/GRES CERAME FIN/FEINSTEINZEUG-KOLLEKTIONEN/GRES PORCELANICO FINO/ФАРФОРОВЫЙ КЕРАМОГРАНИТ

SQUADRATO - SQUARED - EQUARRI - REKTIFIZIERT - ESCUADRADO - КАЛИБРОВАННАЯ

20 mm 3/4" ↑↓	COLOR	SURFACE	60x120 23 ^{5/8"} x47 ^{1/4"}
	LUMIÈRE	STRUCTURÉ	773394 ■ FL-10300
	OMBRE	STRUCTURÉ	773395 ■ FL-10300

ATMOSPHÈRES DE REX

	RESISTENZA ALLA FLESSIONE IN N/mm² N/mm ² FLEXURAL STRENGTH TEST / RESISTANCE A LA FLEXION EN N/mm ² / BIEGESTÄRKEIT IN N/mm ² / RESISTENCIA A LA FLEXION EN N/mm ² / УСТОЙЧИВОСТЬ К ИЗГИБУ В Н/мм ²	valore medio 52 N/mm²
	Forza di rottura in N (sp. > 7,5 mm) Breaking strength in N (thickness > 7,5 mm) / Force de rupture en N (ép. > 7,5 mm) / Bruchlast in N (Dicke > 7,5 mm) / Fuerza de rotura en N (gr. > 7,5 mm) / Разрушающее усилие, Н (толщ. > 7,5 мм)	valore medio 14000 N

PEZZI SPECIALI

Special trims/Pièces spéciales/Formstücke
Piezas especiales/СПЕЦИАЛЬНЫЕ ИЗДЕЛИЯ
pag 188/193

ATMOSPHÈRES DE REX	scatola - box			pallet		
	pz	mq	kg	box	mq	kg
60x120 20mm	1	0,72	32,25	30	21,60	990

ATMOSPHÈRES DE REX

10 mm 3/8" ↑↓	COLOR	SURFACE	30x30 11 ^{4/5"} x11 ^{4/5"} pz/box 11
---------------	-------	---------	--



MIX
HARMONIE
GÉOMÉTRIES

harmonie patiné+harmonie
structuré+lumière canneté

773946
▲ FL-02700

ATMOSPHÈRES DE REX



MIX
CHARME
GÉOMÉTRIES

charme patiné+charme
structuré+ombre canneté

773947
▲ FL-02700

10 mm 3/8" ↑↓	COLOR	SURFACE	39,8x46 15 ^{2/3"} x18 ^{1/9"} pz/box 4
---------------	-------	---------	---



HARMONIE HEXAGONE

SABLÉ

773948
▲ FL-03500



AURORE HEXAGONE

SABLÉ

773949
▲ FL-03500

ATMOSPHÈRES DE REX



CHARME HEXAGONE

SABLÉ

773950
▲ FL-03500



DÉsir HEXAGONE

SABLÉ

773951
▲ FL-03500

10 mm 3/8" ↑↓

COLOR

SURFACE

80x80
31 1/2"x31 1/2"



HARMONIE TAPIS

SABLÉ

773952
■ FL-21500



AURORE TAPIS

SABLÉ

773953
■ FL-21500

ATMOSPHÈRES
DE REX



CHARME TAPIS

SABLÉ

773954
■ FL-21500



DÉsir TAPIS

SABLÉ

773955
■ FL-21500



MYSTÈRE TAPIS

SABLÉ

773956
■ FL-21500

ATMOSPHERES DE REX

PEZZI SPECIALI/SPECIAL TRIMS/PIÈCES SPÉCIALES/FORMSTÜCKE/PIEZAS ESPECIALES/Специальные изделия

10 mm 3/8" ↑		COLOR	SURFACE	4,6x60 1 475/8" x 2 35/8"	33x120x3 1 3" x 4 7 1/4" x 1 1/8"	33x120x3 1 3" x 4 7 1/4" x 1 1/8"	33x120x3 1 3" x 4 7 1/4" x 1 1/8"
				battiscopa	gradino pz/box 2	angolo gradino dx pz/box 2	angolo gradino sx pz/box 2
ATMOSPHERES DE REX	HARMONIE	SABLÉ (NATURALE)		773939 ◆ FL-01600	773919 ▲ FL-20400	773924 ▲ FL-31100	773929 ▲ FL-31100
		PATINÉ (SMOOTH)		773934 ◆ FL-01600	773903 ▲ FL-20400	773908 ▲ FL-31100	773913 ▲ FL-31100
	AURORE	SABLÉ (NATURALE)		773940 ◆ FL-01600	773920 ▲ FL-20400	773925 ▲ FL-31100	773930 ▲ FL-31100
		PATINÉ (SMOOTH)		773935 ◆ FL-01600	773904 ▲ FL-20400	773909 ▲ FL-31100	773915 ▲ FL-31100
	DÉSIR	SABLÉ (NATURALE)		773943 ◆ FL-01600	773922 ▲ FL-20400	773927 ▲ FL-31100	773932 ▲ FL-31100
		PATINÉ (SMOOTH)		773937 ◆ FL-01600	773906 ▲ FL-20400	773911 ▲ FL-31100	773917 ▲ FL-31100
	CHARME	SABLÉ (NATURALE)		773942 ◆ FL-01600	773921 ▲ FL-20400	773926 ▲ FL-31100	773931 ▲ FL-31100
		PATINÉ (SMOOTH)		773936 ◆ FL-01600	773905 ▲ FL-20400	773910 ▲ FL-31100	773916 ▲ FL-31100
	MYSTÈRE	SABLÉ (NATURALE)		773944 ◆ FL-01600	773923 ▲ FL-20400	773928 ▲ FL-31100	773933 ▲ FL-31100
		PATINÉ (SMOOTH)		773938 ◆ FL-01600	773907 ▲ FL-20400	773912 ▲ FL-31100	773918 ▲ FL-31100

FLORIM OVERSIZE
magnUm

120x280/120x240/120x120/60x120

Specifica Imballo pag.
Packaging specifications on page
Spécifications d'emballage à page
Verpackungsdetail Seite
Especificaciones de embalaje a la página
Информация об упаковке на стр.
200/201

Per un effetto ottimale della posa, florim suggerisce di mantenere 2 mm di fuga per pose monofornate e 3 mm per combinare formati misti - For optimal installation results, florim recommends maintaining a joint of 2 mm - 1/12" for single format installations and 3 mm - 1/8" to combine mixed formats. - Pour réaliser une pose parfaite, florim suggère de maintenir 2 mm de joint pour la pose des monofornats, et 3 mm pour les combinaisons de formats mixtes. - Um einen optimalen effekt beim verlegen zu erzielen empfiehlt florim eine 2 mm fugе bei einformatigen verlegungen und 3 mm fugе bei formatkombinationen Para lograr los máximos resultados en la posa del producto, florim aconseja 2 mm de junta en aplicaciones monofornate y 3 mm en combinaciones de formatos mixtos - **ДЛЯ ОПТИМАЛЬНОЙ УКЛАДКИ * FLORIM* РЕКОМЕНДУЕТ ВЫДЕРЖИВАТЬ ЗАЗОР 2 ММ ДЛЯ МОНОФОРМАТА И 3 ММ ПРИ СМЕШАННЫХ ФОРМАТАХ.**

In relazione alle differenti tecnologie produttive l'accostamento di prodotti con spessori diversi potrebbe presentare delle disomogeneità, se ne sconsiglia pertanto l'abbinamento. / Due to the different production technologies, contiguous installation of products with different thickness may give a non-homogeneous result. For this reason we do not recommend this option. / Vu que différentes technologies de production sont utilisées avec des épaisseurs différentes, des problèmes d'homogénéité pourraient se présenter, il est donc déconseillé de les poser ensemble. / Wegen unterschiedlicher Produktionstechnologien können die Fliesen mit verschiedenen Materialstärken optische Differenzen aufweisen. Von einem direkten Aneinanderlegen wird deshalb abgeraten. / Dadas las diferentes tecnologías productivas, la combinación de productos de diferentes espesores podría dar lugar a heterogeneidad, por lo que se desaconseja mezclarlas. / **В связи с различием в технологиях производства, сочетание продукции разной толщины иногда может представлять неоднородность материала. Такие сочетания следует избегать.**

ATMOSPHERES DE REX	scatola - box			pallet		
	pz	mq	kg	box	mq	kg
60x120	2	1,44	31,82	30	43,20	980
80x80	2	1,28	29,80	40	51,20	1220
40x80	3	0,96	22,32	56	53,76	1270
60x60	3	1,08	23,76	40	43,20	980
30x60	6	1,08	23,86	40	43,20	980
80x80 tapis	2	1,28	29,80	20	25,60	620

ATMOSPHERES DE REX	scatola - box			pallet		
	pz	ml	kg	box	mq	kg
4,6x60 battiscopa	14	8,40	8,40	-	-	-





ÉTOILE DE REX

gres porcellanato colorato in massa
coloured body porcelain stoneware
grès cérame colore dans la masse
durchgefärbte feinsteinzeug
gres porcelánico coloreado en masa
керамогранит, окращенный по всей толщине

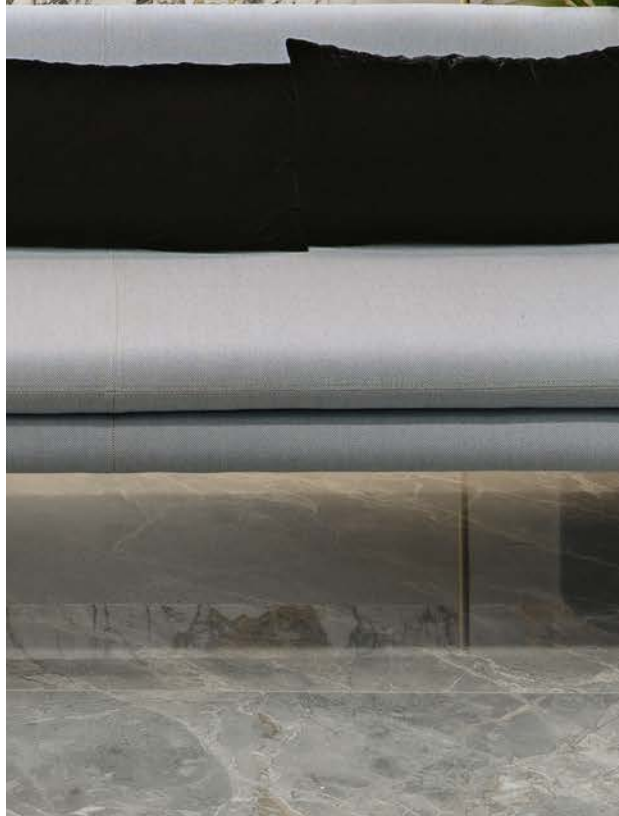



ÉTOILE DE REX

La storia e il futuro sono il binario lungo cui Rex ha improntato la sua ricerca estetica, guardare all'antico con uno sguardo nuovo è il cuore del progetto. Una sfida in cui l'eccellenza vince sul tempo. **Étoile de Rex** è un magico equilibrio tra segni e colori che stimolano la sensorialità invitando al tatto lo spettatore che si trova di fronte alla sua raffinata intensità cromatica. La sintesi perfetta di una eleganza che nasce dalla sorprendente varietà della natura e dalla tecnologia produttiva fortemente all'avanguardia. Una intrinseca vocazione decorativa per una serie che si ispira alle inusuali venature di un minerale pregiato ed estremamente raro, selezionato tra i più inediti. Superfici morbide e luminose accolgono nuances che muovono dal bianco al grigio arrivando fino ai toni più decisi dei verdi che si sviluppano esaltando grafiche suggestive.

History and the future are the two paths along which Rex has pursued its aesthetic research, so that looking at the past from a new perspective lies at the heart of this project. It's a challenge where excellence wins over time. **Étoile de Rex** is a magical balance of symbols and colours that stimulate the senses, inviting the viewer who is gazing at its refined depth of colour to touch it. This is the perfect synthesis of an elegance stemming from the amazing variety to be found in nature and from extremely cutting-edge production technology – an intrinsic decorative vocation for a range inspired by the unusual veining of a highly-prized and very rare mineral, selected from the least-known of them. Soft, bright surface-finishes have nuances ranging from white to grey and right down to more decisive shades of green which, as they develop, highlight suggestive patterns.

C'est sur l'histoire et le futur que Rex a basé sa recherche esthétique en modernisant le passé dans chaque projet. Un défi où l'excellence l'emporte sur le temps. **Étoile de Rex** est un équilibre magique entre les signes et les couleurs qui stimulent les sens en invitant au toucher le spectateur qui se trouve devant son intensité chromatique raffinée. La synthèse parfaite d'une élégance qui naît de la variété surprenante de la nature et de la technologie de production fortement innovante. Une vocation décorative intrinsèque pour une série qui s'inspire des marbrures insolites d'un minéral précieux et extrêmement rare, sélectionné parmi les plus inédits. Des surfaces douces et lumineuses accueillent des nuances qui passent du blanc au gris pour arriver à des tonalités vertes plus intenses dont le développement exalte des graphismes suggestifs.

Geschichte und Zukunft sind der Weg, den Rex mit seiner ästhetischen Forschungstätigkeit begeht. Ein neuer Blick auf das Alte, das ist das Herzstück des Projekts. Eine Herausforderung, bei der die hervorragende Qualität gewinnbringend ist. **Étoile de Rex** ist eine magische Balance zwischen Zeichen und Farben, die die Sinne anregt und den Betrachter mit der edlen Farbintensität zur Berührung einlädt. Die perfekte Synthese einer Eleganz, die sich aus der überraschenden Vielfalt der Natur und der überaus innovativen Produktionstechnologie ergibt. Eine innewohnende dekorative Berufung für eine Serie, die von der ungewöhnlichen Äderung eines kostbaren und extrem seltenen Minerals inspiriert wird, das unter den vollkommen neuartigen Materialien ausgewählt wurde. Weiche und helle Oberflächen heißen Nuancen willkommen, die von Weiß über Grau bis hin zu kräftigeren Grüntönen reichen, die erhebende, stimmungsvolle Grafiken hervorheben.

La historia y el futuro son los dos elementos en los que Rex ha centrado su investigación estética, mirar a lo antiguo con una mirada nueva es la esencia del proyecto. Un desafío en el que la excelencia gana al tiempo. **Étoile de Rex** es un equilibrio mágico entre signos y colores que estimulan la sensorialidad incitando el tacto del espectador que se encuentra frente a su refinada intensidad cromática. La síntesis perfecta de una elegancia que nace de la sorprendente variedad de la naturaleza y de la tecnología productiva muy a la vanguardia. Una vocación decorativa intrínseca para una serie que se inspira en las vetas inusuales de un mineral preciado y extremadamente raro, seleccionado de entre los más inéditos. Superficies suaves y luminosas acogen tonos que van del blanco al gris llegando incluso a los tonos más intensos de los verdes que se desarrollan destacando gráficas sugestivas.

коллекции. Вызов, брошенный времени, в котором победителем становится непревзойденность дизайна. **Étoile de Rex** – это чудесное равновесие между фактурой и цветом, которое стимулирует чувственное восприятие, вызывая у того, кто созерцает яркость и изысканность его цветов, желание потрогать их на ощупь. Превосходное слияние великолепия, созданного удивительным разнообразием природы, и высокоразвитой технологии производства. Этой коллекции, черпающей вдохновение в необычном рисунке прожилок ценного и крайне редкого минерала, выбранного среди самых уникальных, присуща ярко выраженная декоративность. На мягких блестящих поверхностях цветовые нюансы переходят от белого к серому, доходя до более решительных оттенков зеленого, подчеркивая своими проявлениями чарующую красоту узора. Переосмысление материала при сохранении его оригинальной сущности – это самая увлекательная задача для бренда, всегда заботящегося об эволюции стиля.

ÉTOILE DE REX

ÉTOILE RENOIR



ÉTOILE GRIS



DCOF>
0,42 Wet
(matte)

10 mm 3/8" ↑↓



DCOF>
0,42 Wet
(matte)

6 mm 1/4" ↑↓

FLORIM OVERSIZE
magnUm

GRES PORCELLANATO COLORATO IN MASSA/COLOURED BODY PORCELAIN STONWARE
GRÈS CÉRAME COLORE DANS LA MASSE/DURCHGEFÄRBTE FEINSTEINZEUG/GRES PORCELÁNICO COLOREADO EN MASA/керамогранит, окрашенный по всей глщине
SQUADRATO - SQUARED - EQUARRI - REKTIFIZIERT - ESCUADRADO - КАЛИБРОВАННАЯ

				80x180 31 ^{1/2"} x70 ^{5/8"}	80x80 31 ^{1/2"} x31 ^{1/2"}	40x80 15 ^{3/4"} x31 ^{1/2"}	60x120 23 ^{5/8"} x47 ^{1/4"}	60x60 23 ^{5/8"} x23 ^{5/8"}
ÉTOILE DE REX	ÉTOILE RENOIR	GLOSSY		761661 ■ FL-11900	761670 ■ FL-10800	761687 ■ FL-09100	761679 ■ FL-11300	761695 ■ FL-09100
		MATTE		761657 ■ FL-10500	761665 ■ FL-09300	761683 ■ FL-07300	761674 ■ FL-09900	761691 ■ FL-07300
	ÉTOILE GRIS	GLOSSY		761662 ■ FL-11900	761671 ■ FL-10800	761688 ■ FL-09100	761680 ■ FL-11300	761696 ■ FL-09100
		MATTE		761658 ■ FL-10500	761667 ■ FL-09300	761684 ■ FL-07300	761676 ■ FL-09900	761692 ■ FL-07300

				120x280 47 ^{1/4"} x110 ^{1/4"}	120x240 47 ^{1/4"} x94 ^{1/2"}	120x120 47 ^{1/4"} x47 ^{1/4"}	60x120 23 ^{5/8"} x47 ^{1/4"}
ÉTOILE DE REX	ÉTOILE RENOIR	GLOSSY		761727 ■ FL-15100	761737 ■ FL-14000	761749 ■ FL-12400	761773 ■ FL-11300
		MATTE		761723 ■ FL-12400	761731 ■ FL-11300	761743 ■ FL-09700	761767 ■ FL-09100
	ÉTOILE GRIS	GLOSSY		761728 ■ FL-15100	761738 ■ FL-14000	761750 ■ FL-12400	761774 ■ FL-11300
		MATTE		761724 ■ FL-12400	761732 ■ FL-11300	761744 ■ FL-09700	761768 ■ FL-09100

ÉTOILE CRÈME



ÉTOILE TROPICAL



V2
ÉTOILE
CRÈME

V3
ÉTOILE
TROPICAL

DCOF >
0,42 Wet
(matte)

10 mm 3/8" ↑↓



V2
ÉTOILE
CRÈME

DCOF >
0,42 Wet
(matte)

6 mm 1/4" ↑↓

FLORIM OVERSIZE
magnUm

GRES PORCELLANATO COLORATO IN MASSA/COLOURED BODY PORCELAIN STONEWARE
GRÈS CÉRAME COLORE DANS LA MASSE/DURCHGEFÄRBT FEINSTEINZEUG/GRES PORCELÁNICO COLOREADO EN MASA/керамогранит, окрашенный по всей тлщине
SQUADRATO - SQUARED - EQUARRI - REKTIFIZIERT - ESCUADRADO - КАЛИБРОВАННАЯ

				80x180 31 ^{1/2"} x70 ^{5/8"}	80x80 31 ^{1/2"} x31 ^{1/2"}	40x80 15 ^{3/4"} x31 ^{1/2"}	60x120 23 ^{5/8"} x47 ^{1/4"}	60x60 23 ^{5/8"} x23 ^{5/8"}
ÉTOILE DE REX		ÉTOILE CRÈME	GLOSSY	761663 ■ FL-11900	761672 ■ FL-10800	761689 ■ FL-09100	761681 ■ FL-11300	761697 ■ FL-09100
			MATTE	761659 ■ FL-10500	761668 ■ FL-09300	761685 ■ FL-07300	761677 ■ FL-09900	761693 ■ FL-07300
		ÉTOILE TROPICAL	GLOSSY	761664 ■ FL-11900	761673 ■ FL-10800	761690 ■ FL-09100	761682 ■ FL-11300	761698 ■ FL-09100
			MATTE	761660 ■ FL-10500	761669 ■ FL-09300	761686 ■ FL-07300	761678 ■ FL-09900	761694 ■ FL-07300
ÉTOILE DE REX			GLOSSY	761729 ■ FL-15100	761739 ■ FL-14000	761751 ■ FL-12400	761775 ■ FL-11300	
			MATTE	761725 ■ FL-12400	761733 ■ FL-11300	761745 ■ FL-09700	761769 ■ FL-09100	

ÉTOILE DE REX

ÉTOILE SYMPHONIE





ÉTOILE ILLUSION



V3
DCOF >
0,42 Wet
(matte)

6 mm 1/4" ↑
FLOHM OVERSIZE
magnUm

GRES PORCELLANATO COLORATO IN MASSA/COLOURED BODY PORCELAIN STONEWARE
GRÈS CÉRAME COLORE DANS LA MASSE/DURCHGEFÄRBTE FEINSTEINZEUG/GRES PORCELÁNICO COLOREADO EN MASA/керамогранит, окрашенный по всей толщине
SQUADRATO - SQUARED - EQUARRI - REKTIFIZIERT - ESCUADRADO - КАЛИБРОВАННАЯ

			6 mm 1/4" ↑			
		COLOR	SURFACE	120x240 47 ^{1/4} "x94 ^{1/2} "	120x120 47 ^{1/4} "x47 ^{1/4} "	60x120 23 ^{5/8} "x47 ^{1/4} "
ÉTOILE DE REX		ÉTOILE SYMPHONIE	GLOSSY	761741 ■ FL-14000	761753 ■ FL-12400	761777 ■ FL-11300
			MATTE	761735 ■ FL-11300	761747 ■ FL-09700	761771 ■ FL-09100
		ÉTOILE ILLUSION	GLOSSY	761742 ■ FL-14000	761754 ■ FL-12400	761778 ■ FL-11300
			MATTE	761736 ■ FL-11300	761748 ■ FL-09700	761772 ■ FL-09100



ÉTOILE DE REX

10 mm 3/8" ↑↓		COLOR	SURFACE	30x30 11 ^{4/5"} x11 ^{4/5"} mosaico tessere 3x15 pz/box 11	30x30 11 ^{4/5"} x11 ^{4/5"} mosaico mix tessere 3x3 pz/box 9
ÉTOILE DE REX		ÉTOILE RENOIR	GLOSSY	761847 ▲ FL-02200	761839 ▲ FL-04900
			MATTE	761843 ▲ FL-02100	
		ÉTOILE GRIS	GLOSSY	761848 ▲ FL-02200	761840 ▲ FL-04900
			MATTE	761844 ▲ FL-02100	
		ÉTOILE CRÈME	GLOSSY	761849 ▲ FL-02200	761841 ▲ FL-04900
			MATTE	761845 ▲ FL-02100	
		ÉTOILE TROPICAL	GLOSSY	761850 ▲ FL-02200	761842 ▲ FL-04900
			MATTE	761846 ▲ FL-02100	

PEZZI SPECIALI/SPECIAL TRIMS/PIÈCES SPÉCIALES/FORMSTÜCKE/PIEZAS ESPECIALES/Специальные изделия







10 mm 3/8" ↑↓		COLOR	SURFACE	4,6x60 1 ^{4/5"} x23 ^{5/8"} battiscopa	33x120x3 13 ^{1/4"} x47 ^{1/4"} x1 ^{1/8"} gradino pz/box 2
ÉTOILE DE REX		ÉTOILE RENOIR	GLOSSY	761855 ◆ FL-01600	761835 ▲ FL-22600
			MATTE	761851 ◆ FL-01600	761831 ▲ FL-20400
		ÉTOILE GRIS	GLOSSY	761856 ◆ FL-01600	761836 ▲ FL-22600
			MATTE	761852 ◆ FL-01600	761832 ▲ FL-20400
		ÉTOILE CRÈME	GLOSSY	761857 ◆ FL-01600	761837 ▲ FL-22600
			MATTE	761853 ◆ FL-01600	761833 ▲ FL-20400
		ÉTOILE TROPICAL	GLOSSY	761858 ◆ FL-01600	761838 ▲ FL-22600
			MATTE	761854 ◆ FL-01600	761834 ▲ FL-20400

Per un effetto ottimale della posa, florim suggerisce di mantenere 2 mm di fuga per pose monofornate e 3 mm per combinare formati misti - For optimal installation results, florim recommends maintaining a joint of 2 mm 1/12" for single format installations and 3 mm 1/8" to combine mixed formats. - Pour réaliser une pose parfaite, florim suggère de maintenir 2 mm de joint pour la pose des monofornats, et 3 mm pour les combinaisons de formats mixtes. - Um einen optimalen effekt beim verlegen zu erzielen empfiehlt florim eine 2 mm fugе bei einformatigen verlegungen und 3 mm fugе bei formatkombinationen Para lograr los máximos resultados en la posa del producto, florim aconseja 2 mm de junta en aplicaciones monofornate y 3 mm en combinaciones de formatos mixtos - **ДЛЯ ОПТИМАЛЬНОЙ УКЛАДКИ - FLORIM РЕКОМЕНДУЕТ ВЫДЕРЖИВАТЬ ЗАЗОР 2 ММ ДЛЯ МОНОФОРМАТА И 3 ММ ПРИ СМЕШАННЫХ ФОРМАТАХ.**





In relazione alle differenti tecnologie produttive l'accostamento di prodotti con spessori diversi potrebbe presentare delle disomogeneità, se ne sconsiglia pertanto l'abbinamento. / Due to the different production technologies, contiguous installation of products with different thickness may give a non-homogeneous result. For this reason we do not recommend this option. / Vu que différentes technologies de production sont utilisées avec des épaisseurs différentes, des problèmes d'homogénéité pourraient se présenter, il est donc déconseillé de les poser ensemble. / Wegen unterschiedlicher Produktionstechnologien können die Fliesen mit verschiedenen Materialstärken optische Differenzen aufweisen. Von einem direkten Aneinanderlegen wird deshalb abgeraten. / Dadas las diferentes tecnologías productivas, la combinación de productos de diferentes espesores podría dar lugar a heterogeneidad, por lo que se desaconseja mezclarlas. / В связи с различием в технологиях производства, сочетание продукции разной толщины иногда может представлять неоднородность материала. Такие сочетания следует избегать.

ÉTOILE DE REX	scatola - box			pallet		
	pz	mq	kg	box	mq	kg
80x180	2	2,88	67,20	20	57,60	1400
80x80	2	1,28	29,80	40	51,20	1220
40x80	3	0,96	22,00	56	53,76	1260
60x120	2	1,44	31,70	30	43,20	980
60x60	3	1,08	23,80	40	43,20	980

ÉTOILE DE REX	scatola - box			pallet		
	pz	ml	kg	box	mq	kg
4,6x60 battiscopa	14	8,40	8,40	-	-	-

6 mm 1/4" ↑↓				30x30 1 14/5" x 1 14/5"  mosaico tessere 7,5x7,5 pz/box 11	30x30 1 14/5" x 1 14/5"  muretto tessere 7,5x15 pz/box 11
		COLOR	SURFACE		
ÉTOILE DE REX		ÉTOILE RENOIR	GLOSSY	761825 ▲ FL-02100	761813 ▲ FL-02100
			MATTE	761819 ▲ FL-01800	761807 ▲ FL-01800
		ÉTOILE GRIS	GLOSSY	761826 ▲ FL-02100	761814 ▲ FL-02100
			MATTE	761820 ▲ FL-01800	761808 ▲ FL-01800
		ÉTOILE CRÈME	GLOSSY	761827 ▲ FL-02100	761815 ▲ FL-02100
			MATTE	761821 ▲ FL-01800	761809 ▲ FL-01800
		ÉTOILE SYMPHONIE	GLOSSY	761829 ▲ FL-02100	761817 ▲ FL-02100
			MATTE	761823 ▲ FL-01800	761811 ▲ FL-01800
		ÉTOILE ILLUSION	GLOSSY	761830 ▲ FL-02100	761818 ▲ FL-02100
			MATTE	761824 ▲ FL-01800	761812 ▲ FL-01800

PEZZI SPECIALI/SPECIAL TRIMS/PIÈCES SPÉCIALES/FORMSTÜCKE/PIEZAS ESPECIALES/Специальные изделия

6 mm 1/4" ↑↓				4,6x80 1 4/5" x 3 1/2"  battiscopa
		COLOR	SURFACE	
ÉTOILE DE REX		ÉTOILE RENOIR	GLOSSY	761803 ◆ FL-01800
			MATTE	761799 ◆ FL-01800
		ÉTOILE GRIS	GLOSSY	761804 ◆ FL-01800
			MATTE	761800 ◆ FL-01800
		ÉTOILE CRÈME	GLOSSY	761805 ◆ FL-01800
			MATTE	761801 ◆ FL-01800

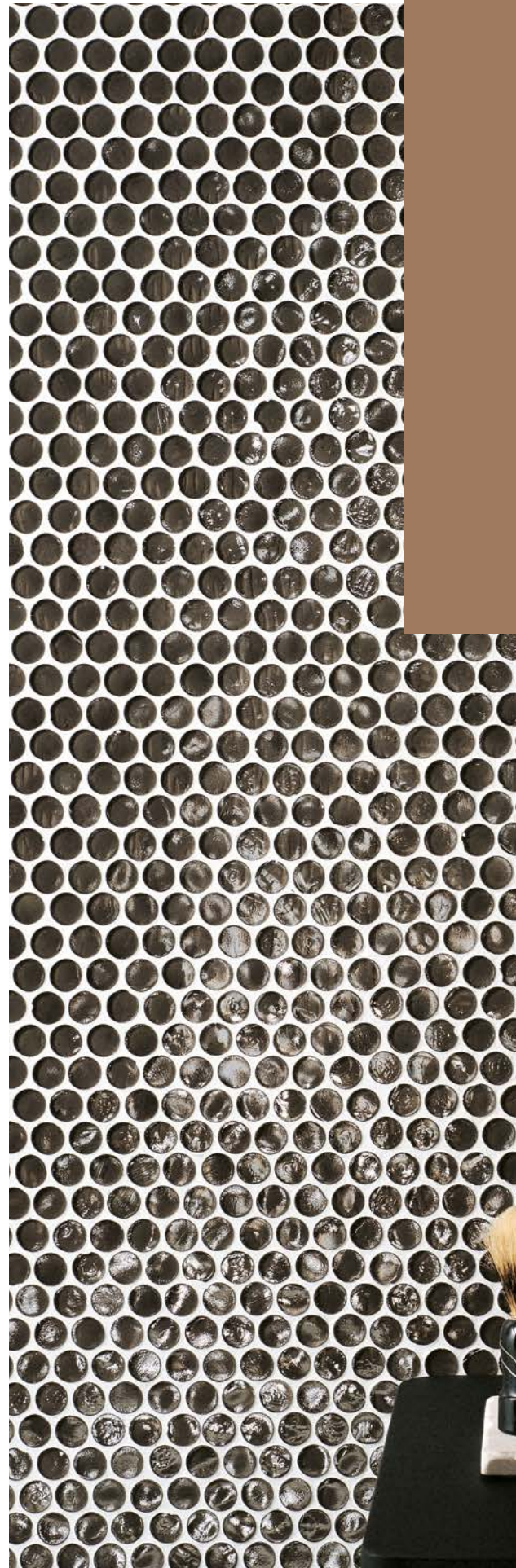

EXTRA LIGHT

mosaico di vetro
glass mosaic tiles
mosaïque en verre
glasmaik
mosaico vitreo
СТЪЛЯННКА МОЗКИК





EXTRA LIGHT

Colore e trasparenza all'insegna di una modularità che permette di rivestire qualsiasi superficie. La ricchezza della cartella colori s'immerge in una dimensione di chiara lucentezza che ha la capacità di vestire l'urbano contemporaneo.

Colour and transparency for a modularity that makes it possible to cover any type of surface. The wide colour selection is immersed in a dimension of clear brilliance to adorn contemporary urban contexts.

Couleur et transparence réunies sous le signe d'une modularité qui permet de recouvrir toutes les surfaces. L'éventail de couleurs plonge dans une dimension brillante et claire, en mesure de revêtir l'urbain contemporain.

Farbe und Transparenz im Zeichen einer Modularität, welche die Verkleidung einer jeden Oberfläche erlaubt. Die Reichhaltigkeit der Farbkarte taucht ein in eine Dimension von klarem Glanz, der in der Lage ist, die zeitgenössische städtische Umwelt einzukleiden.

Color y transparencia bajo el estandarte de una modularidad que permite revestir cualquier superficie. La riqueza de la carta de colores se sumerge en una dimensión de nítida luminosidad con la capacidad de ofrecer una decoración urbana contemporánea.

Сочетание цвета и прозрачности в модульной компоновке позволяет оформить любую поверхность. Богатство предложенных цветов рассматривается сквозь блестящую призму для представления современного облика города.

EXTRA LIGHT

WHITE MOSAICO CIRCLE



DIAMOND MOSAICO CIRCLE

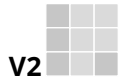

V2
CLASSE
A+B+C
DIN 51097

OYSTER MOSAICO CIRCLE



ZINC MOSAICO CIRCLE



JADE MOSAICO CIRCLE



LIME MOSAICO CIRCLE



MOSAICO DI VETRO
GLASS MOSAIC TILES/MOSAÏQUE EN VERRE/GLASMOSAÏK/MOSAICO VÍTREO/СТЪКЛЯНКА МОЗКИК

4,3 mm \updownarrow 1 ^{5/8} "	COLOR	29,5x27,7 11 ^{3/5} "x11" Ø 1,8 cm 3/4"
	WHITE	735614 ▲ FL-01900
	DIAMOND	735613 ▲ FL-01900
	OYSTER	735615 ▲ FL-01900
	ZINC	735611 ▲ FL-01900
	JADE	735612 ▲ FL-01900
	LIME	735610 ▲ FL-01900

EXTRA LIGHT

MOSAICO

montato su pellicola trasparente
mounted on transparent film
monté sur film transparent
auf transparenter Folie montiert
montado en una película transparente
установленный на прозрачной пленке

MINK MOSAICO CIRCLE



MOU MOSAICO CIRCLE



OCHER MOSAICO CIRCLE



V2



CLASSE
A+B+C
DIN 51097

MOSAICO DI VETRO

GLASS MOSAIC TILES/MOSAÏQUE EN VERRE/GLASMOSAÏK/MOSAICO VÍTREO/СТЫКЛЯННИКА МОЗКИК

4,3 mm 1 ⁵⁰ mm	COLOR	29,5x27,7 11 ^{3/5} "x11" Ø 1,8 cm 3/4"
	MINK	735843 ▲ FL-01900
EXTRA LIGHT		MOU 735844 ▲ FL-01900
		OCHER 735842 ▲ FL-01900

MOSAICO

montato su pellicola trasparente
mounted on transparent film
monté sur film transparent
auf transparenter Folie montiert
montado en una película transparente
установленный на прозрачной пленке

Per le informazioni sulla posa consultare il sito florim.com
For installation information please, visit the website florim.com
Pour plus d'informations sur l'installation visitez le site florim.com
Informationen zur Installation entnehmen Sie unserer Website florim.com
Para más información de instalación, visite el sitio web florim.com

EXTRA LIGHT	scatola - box			pallet		
	pz	mq	kg	box	mq	kg
29,5x27,7	11	-	8,00	-	-	-



GOLD

vetro e foglia oro
gold leaf with glass overlay
verre et feuille d'or
glas und Blattgold
vidrio y pan de oro
стекло и золотой лист



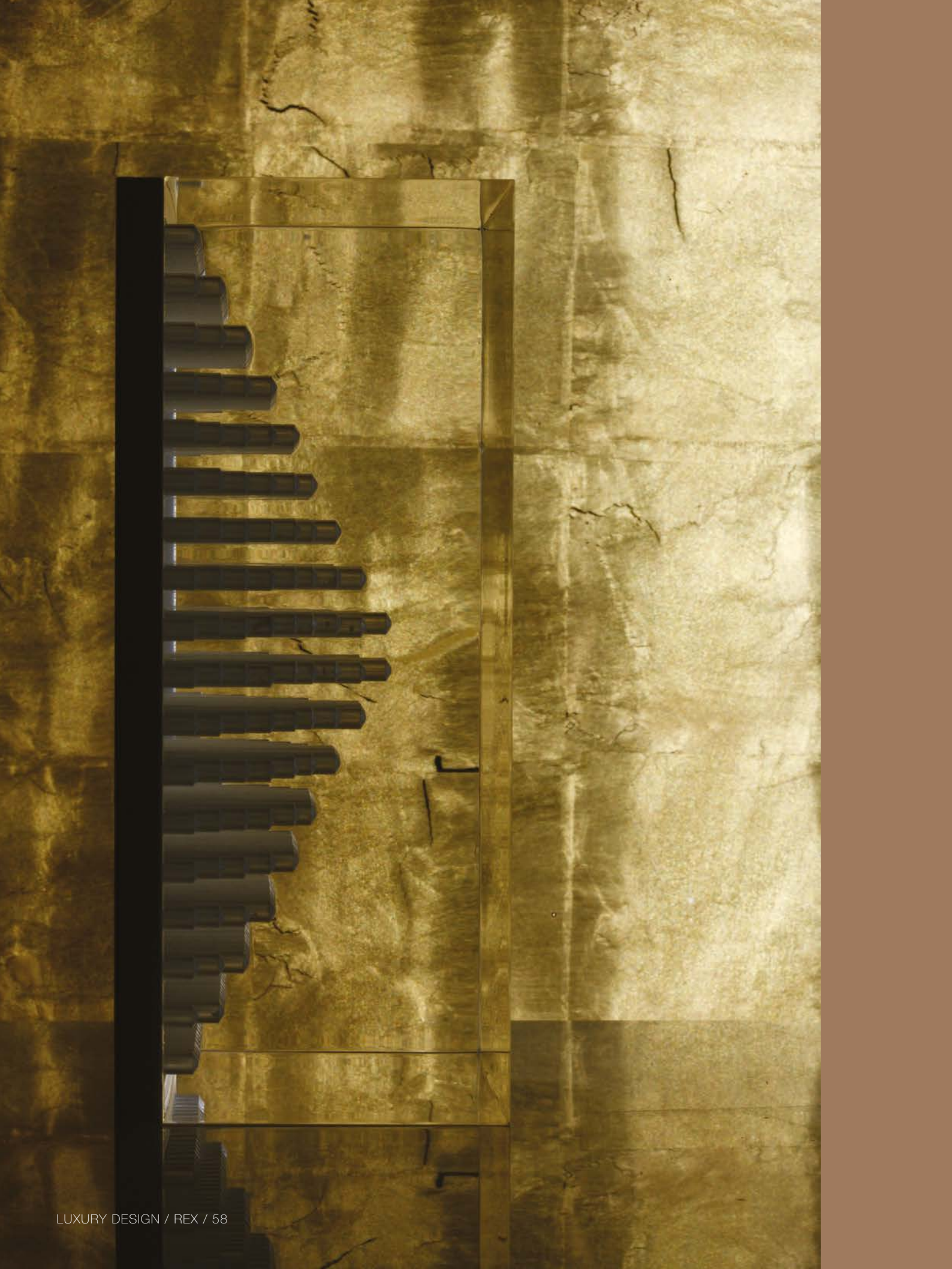

GOLD

L'antico decoro a foglia d'oro, utilizzato per stucchi e mobili preziosi, viene aggiornato e reinterpretato da Rex. Proposta tra due lastre di vetro lucido, assume ancora più valore e diventa complemento integrante e decorativo delle pareti Rex.

Rex brings traditional gold leaf decoration, used for fine mouldings and furniture, right up to date. Placed between two sheets of shiny glass, this material acquires even greater value and becomes an integral, decorative part of Rex wall coverings.

Le décor antique à la feuille d'or, que l'on utilisait pour dorer les stucs et les meubles précieux, est remis au goût du jour et réinterprété par Rex. Entre deux plaques de verre brillant, la feuille d'or prend encore plus de valeur et devient un complément qui intègre et décore les murs Rex.

Das antike Blattgold-Dekor, das für Stuckwerke und wertvolle Möbel verwendet wurde, wird von Rex aktualisiert und neu interpretiert. Zwischen zwei Glasscheiben erhöht sich sein Wert noch, und es wird zur integrierenden und dekorativen Ergänzung der Rex-Wände.

La antigua decoración con pan de oro, utilizada en estucados y muebles de valor, ha sido reinterpretada y modernizada por Rex. Propuesta entre dos láminas de vidrio brillante, asume más valor aún y se convierte en complemento integrante y decorativo de las paredes Rex.

Облицовочный материал коллекции «Gold» олицетворяет древний декор золотого листа применяемого при замазке ценной мебели. Коллекция, пополненная новейшими достижениями и предоставленная компанией «Rex». Предложенная коллекция представляется в виде двух пластин глянцевое стекла, приобретает ещё большую ценность и становится дополняющим и декоративным компонентом поверхностей компании «Rex».

GOLD

GOLD



10 mm 3/8" ↑↓

VETRO E FOGLIA ORO/GOLD LEAF WITH GLASS OVERLAY
VERRE ET FEUILLE D'OR/GLAS UND BLATTGOLD/MIDRIO Y PAN DE ORO/стекло и золотой лист

10 mm 3/8" ↑↓	COLOR	SURFACE	40x60 15 ^{3/4} "x23 ^{5/8} "	10x60 4"x23 ^{5/8} "
GOLD	 GOLD	GLOSSY	721751 ▲ FL-73900	721745 ▲ FL-17800

Da utilizzare solo a rivestimento.
To be used as coating only.
Da utiliser uniquement comme revêtement.
Nur als Wandbelag zu nutzen.
Usar sólo con revestimiento.
должна использоваться только для облицовки.

Si consiglia la posa del materiale in ambienti con temperature comprese tra -20°C e +40°C.
Laying of the material is recommended in environments with temperatures between -20°C and +40°C.
Pose conseillée dans les pièces avec une température comprise entre -20 °C et +40 °C.
Es wird zur Verlegung des Materials in Bereichen mit Temperaturen zwischen -20°C und +40°C empfohlen.
Se recomienda colocar el material en ambientes con una temperatura comprendida entre -20° C y +40° C.
рекомендуется укладка материала в помещениях с температурой от -20°С до +40°С.

GOLD	scatola - box			pallet		
	pz	mq	kg	box	mq	kg
40x60	1	-	8,00	-	-	-
10x60	4	-	8,00	-	-	-





LUXURY DESIGN / REX / 62



I CLASSICI DI REX

gres porcellanato colorato in massa
coloured body porcelain stoneware
grès cérame colore dans la masse
durchgefärbte feinsteinzeug
gres porcelánico coloreado en masa
керамогранит, окращенный по всей толщине

decò wood:

gres fine porcellanato
fine porcelain stoneware
grès cérame fin
feinsteinzeug-kollektionen
gres porcelánico fino
фарфоровый керамогранит





I CLASSICI DI REX

Il prezioso contenitore de **I Classici** si arricchisce di nuovi suggestivi prodotti: 4 marmi ricercati che riportano alla mente eleganti atmosfere anni cinquanta tradotte in una fresca e inattesa modernità. Ingredienti perfetti per un progetto tailor made che traccia una nuova linea di lusso racchiuso nelle linee eleganti e fluide e nei contrasti di chiaro scuro. Un forte carattere estetico permette di creare uno spazio architettonico con un approccio personale e libero da vincoli predefiniti per la realizzazione di un luogo autentico e del tutto affine al proprio immaginario dell'abitare. Una vibrante energia si riflette dal prodotto al progetto portando con sé contemporaneamente la nostalgia del passato e l'innovazione del futuro.

The valuable container of **I Classici** is further enriched with suggestive products: 4 sought-after marbles bringing to mind the elegant atmosphere of the fifties, interpreted with a fresh and unexpected modern accent. Perfect ingredients for a tailor-made project, which draws a new line of luxury, enveloped in sleek, flowing lines and chiaroscuro contrasts. A strong aesthetic character for us to create architectural areas, using an approach which is personal and free of pre-defined constraints, designing authentic settings, fully in tune with our personal concepts of living. Vibrant energy reflects from the product to the project, bringing with it both nostalgia for the past and innovation for the future.

La précieuse collection « **I Classici** » s'enrichit de nouveaux produits de charme: 4 marbres raffinés qui évoquent les atmosphères élégantes des années '50, revisitées au goût du jour dans un style frais et surprenant. Des ingrédients parfaits pour un projet sur mesure, traçant une nouvelle ligne de luxe, qui s'exprime dans les lignes élégantes et fluides ainsi que dans les contrastes de clair-obscur. Un fort caractère esthétique permet de créer un espace architectural avec une approche personnelle et libre de contraintes pour la réalisation d'un lieu authentique et s'inscrivant parfaitement dans l'imaginaire individuel de l'habiter. Une énergie vibrante se reflète du produit au projet, mêlant nostalgie du passé et innovation du futur.

Die kostbare Kollektion "**I Classici**" wird um neue, bezaubernde Produkte erweitert: 4 edle Marmorvarianten, die an die elegante Atmosphäre der 50er Jahre erinnern und zugleich auf frische, unerwartet moderne Art und Weise interpretiert wurden. Perfekte Elemente für ein maßgeschneidertes Projekt, das eine neue, durch elegante, fließende Linien und Hell-Dunkel-Kontraste gekennzeichnete Vorstellung von Luxus einführt. Dem starken ästhetischen Charakter ist es zu verdanken, dass ein individueller architektonischer Raum ohne festgelegte Vorgaben entsteht, in dem sich ein authentischer Ort realisieren lässt, der voll und ganz der eigenen Wohnvorstellung entspricht. Eine vibrierende Energie überträgt sich vom Produkt auf das Projekt und bringt gleichzeitig Sehnsucht nach der Vergangenheit und die Innovation der Zukunft mit sich.

La preciosa colección de **I Classici** se enriquece con nuevos y sugerentes productos: 4 mármoles refinados que nos traen a la mente elegantes atmósferas de los años cincuenta traducidas a una fresca e inesperada modernidad. Ingredientes perfectos para un proyecto tailor made que traza una nueva línea de lujo comprendido en las líneas elegantes y fluidas y en los contrastes de claroscuro. Un fuerte carácter estético permite crear un espacio arquitectónico con un planteamiento personal y libre de vínculos predefinidos para la realización de un lugar auténtico y completamente afín al propio imaginario del hogar. Una vibrante energía se refleja del producto al proyecto, llevando consigo al mismo tiempo la nostalgia del pasado y la innovación del futuro.

Коллекция **I Classici** пополнилась новыми изысканными изделиями: четырьмя ценными видами мрамора, призванными воссоздать элегантную стилистику 50-х, но в этот раз в совершенно неординарной современной интерпретации. Новые модели воплощают собой новое видение роскоши, заключенной в элегантные плавные контуры и контрасты светотени. Темпераментная эстетика и отсутствие каких-либо стилистических ограничений позволяет реализовать любые индивидуальные проекты в аутентичном стиле. Вибрирующая энергия, которая передается от единичного изделия к целому архитектурному пространству, несет в себе приятную ностальгию по прошлому и новый взгляд в будущее.

I CLASSICI DI REX

STATUARIO



CALACATTA GOLD

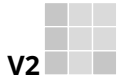

V2
DCOF>
0,42 Wet
(matte/soft)

10 mm 3/8" ↑↓

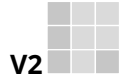

V2
DCOF>
0,42 Wet
(matte/soft)

6 mm 1/4" ↑↓

FLORIM OVERSIZE
magnum

GRES PORCELLANATO COLORATO IN MASSA/COLOURED BODY PORCELAIN STONEWARE
GRÈS CÉRAMÉ COLORE DANS LA MASSE/DURCHGEFÄRBTE FEINSTEINZEUG/GRES PORCELÁNICO COLOREADO EN MASA/керамогранит, окращенный по всей толщине
SQUADRATO - SQUARED - EQUARRI - REKTIFIZIERT - ESCUADRADO - КАЛИБРОВАННАЯ

				10 mm 3/8" ↑↓		6 mm 1/4" ↑↓																			
		COLOR	SURFACE	80x80 31 ^{1/2} "x31 ^{1/2} "	60x120 23 ^{5/8} "x47 ^{1/4} "	30x120 11 ^{4/5} "x47 ^{1/4} "	60x60 23 ^{5/8} "x23 ^{5/8} "	30x60 11 ^{4/5} "x23 ^{5/8} "	COLOR	SURFACE	160x320 63"x126"	120x280 47 ^{1/4} "x110"	160x160 63"x63"	120x240 47 ^{1/4} "x94 ^{1/2} "	80x240 31 ^{1/2} "x94 ^{1/2} "	120x120 47 ^{1/4} "x47 ^{1/4} "	80x80 31 ^{1/2} "x31 ^{1/2} "	60x120 23 ^{5/8} "x47 ^{1/4} "							
I CLASSICI DI REX		STATUARIO	GLOSSY	746591 ■ FL-11300	746592 ■ FL-12400	746593 ■ FL-13400	746590 ■ FL-11300	754467 ■ FL-07700		CALACATTA GOLD	GLOSSY	750715 ■ FL-11300	750714 ■ FL-11900	750713 ■ FL-11900	750719 ■ FL-09700	754469 ■ FL-07700	GLOSSY	746607 ■ FL-18800	757833 ■ FL-15100	746606 ■ FL-16100	746605 ■ FL-14000	746603 ■ FL-13400	746604 ■ FL-12400	746601 ■ FL-10300	746602 ■ FL-11300
			SOFT	746587 ■ FL-09700	746588 ■ FL-10800	746589 ■ FL-11300	746585 ■ FL-09300	754466 ■ FL-07000			SOFT	746600 ■ FL-15600	757832 ■ FL-12400	746599 ■ FL-13400	746598 ■ FL-11300	746596 ■ FL-10300	746597 ■ FL-09700	746594 ■ FL-08400	746595 ■ FL-09100						
	GLOSSY	750715 ■ FL-11300	750714 ■ FL-11900	750713 ■ FL-11900	750719 ■ FL-09700	754469 ■ FL-07700	GLOSSY	750673 ■ FL-18800			757835 ■ FL-15100	750701 ■ FL-16100	750682 ■ FL-14000	750683 ■ FL-13400	750702 ■ FL-12400	750704 ■ FL-10300	750703 ■ FL-11300								
	MATTE	753297 ■ FL-09700	753296 ■ FL-10500	753295 ■ FL-10500	753298 ■ FL-08100	754468 ■ FL-06400	MATTE	753282 ■ FL-15600			757834 ■ FL-12400	753291 ■ FL-13400	753280 ■ FL-11300	753281 ■ FL-10300	753292 ■ FL-09700	753294 ■ FL-08400	753293 ■ FL-09100								

MARQUINIA



BRAZILIAN



V2
MARQUINIA

DCOF>
0,42 Wet
(matte)

V3
BRAZILIAN



10 mm 3/8" ↑↓

V2

6 mm 1/4" ↑↓

FLOHM OVERSIZE
magnUm

GRES PORCELLANATO COLORATO IN MASSA/COLOURED BODY PORCELAIN STONEWARE
GRÈS CÉRAMÉ COLORE DANS LA MASSE/DURCHGEFÄRBTE FEINSTEINZEUG/GRES PORCELÁNICO COLOREADO EN MASA/керамогранит, окрашенный по всей толщине
SQUADRATO - SQUARED - EQUARRI - REKTIFIZIERT - ESCUADRADO - КАЛИБРОВАННАЯ

10 mm 3/8" ↑↓		COLOR	SURFACE	80x180 31 ^{1/2} "x70 ^{5/8} "	80x80 31 ^{1/2} "x31 ^{1/2} "	60x120 23 ^{5/8} "x47 ^{1/4} "	30x120 11 ^{4/5} "x47 ^{1/4} "	60x60 23 ^{5/8} "x23 ^{5/8} "	30x60 11 ^{4/5} "x23 ^{5/8} "
I CLASSICI DI REX		MARQUINIA	GLOSSY	750874 ■ FL-13400	750877 ■ FL-11300	750876 ■ FL-11900	750875 ■ FL-11900	750878 ■ FL-09700	754471 ■ FL-07700
			MATTE	751912 ■ FL-11300	751915 ■ FL-09700	751914 ■ FL-10500	751913 ■ FL-10500	751916 ■ FL-08100	754470 ■ FL-06400
		BRAZILIAN	GLOSSY	750898 ■ FL-13400	750901 ■ FL-11300	750900 ■ FL-11900	750899 ■ FL-11900	755469 ■ FL-09700	754472 ■ FL-07700
6 mm 1/4" ↑↓		COLOR	SURFACE	160x320 63"x126"	160x160 63"x63"	120x240 47 ^{1/4} "x94 ^{1/2} "	120x120 47 ^{1/4} "x47 ^{1/4} "	80x80 31 ^{1/2} "x31 ^{1/2} "	60x120 23 ^{5/8} "x47 ^{1/4} "
I CLASSICI DI REX		MARQUINIA	GLOSSY	750776 ■ FL-18800	750886 ■ FL-16100	750885 ■ FL-14000	750884 ■ FL-12400	757839 ■ FL-10300	750883 ■ FL-11300
			MATTE	751942 ■ FL-15600	751924 ■ FL-13400	751923 ■ FL-11300	751922 ■ FL-09700	757838 ■ FL-08400	751921 ■ FL-09100

I CLASSICI DI REX

PORTORO



10 mm 3/8" ↑↓

GRES PORCELLANATO COLORATO IN MASSA/COLOURED BODY PORCELAIN STONEWARE
 GRÈS CÉRAMÉ COLORE DANS LA MASSE/DURCHGEFÄRBTE FEINSTEINZEUG/GRES PORCELÁNICO COLOREADO EN MASA/керамогранит, окрашенный по всей тлщине
 SQUADRATO - SQUARED - EQUARRI - REKTIFIZIERT - ESCUADRADO - КАЛИБРОВАННАЯ

10 mm 3/8" ↑↓	COLOR	SURFACE	80x180 31 ^{1/2"} x70 ^{6/7"}	80x80 31 ^{1/2"} x31 ^{1/2"}	60x120 23 ^{5/8"} x47 ^{1/4"}	30x120 11 ^{4/5"} x47 ^{1/4"}	60x60 23 ^{5/8"} x23 ^{5/8"}	30x60 11 ^{4/5"} x23 ^{5/8"}
I CLASSICI DI REX	PORTORO	GLOSSY	750912 ■ FL-13400	750915 ■ FL-11300	750914 ■ FL-11900	750913 ■ FL-11900	755470 ■ FL-09700	754473 ■ FL-07700

DECÒ WOOD WHITE



DECÒ WOOD PEARL





V3

R9
CLASSE A

DCOF >
0,42 Wet

10 mm 3/8" ↑↓

GRES FINE PORCELLANATO/FINE PORCELAIN STONEWARE
GRES CERAME FIN/FEINSTEINZEUG-KOLLEKTIONEN/GRES PORCELANICO FINO/ФАРФОРОВЫЙ КЕРАМОГРАНИТ
SQUADRATO - SQUARED - EQUARRI - REKTIFIZIERT - ESCUADRADO - КАЛИБРОВАННАЯ

			10 mm 3/8" ↑↓					
		COLOR	SURFACE	30x120 11 ^{4/5"} x47 ^{1/4"}	20x120 7 ^{7/8"} x47 ^{1/4"}	15x120 6"x47 ^{1/4"}	26,5x180 10 ^{3/7"} x70 ^{6/7"}	20x180 7 ^{7/8"} x70 ^{6/7"}
I CLASSICI DI REX		DECÒ WOOD WHITE	MATTE	748505 ■ FL-09300	748508 ■ FL-09300	748511 ■ FL-09300	748519 ■ FL-12400	748515 ■ FL-12400
		DECÒ WOOD PEARL	MATTE	748506 ■ FL-09300	748509 ■ FL-09300	748512 ■ FL-09300	748520 ■ FL-12400	748517 ■ FL-12400

I CLASSICI DI REX

DECÒ WOOD BLACK



V3

R9
CLASSE A

DCOF>
0,42 Wet

10 mm 3/8" ↑↓

GRES FINE PORCELLANATO/FINE PORCELAIN STONWARE
GRES CERAME FIN/FEINSTEINZEUG-KOLLEKTIONEN/GRES PORCELANICO FINO/ФАРФОРОВЫЙ КЕРАМОГРАНИТ
SQUADRATO - SQUARED - EQUARRI - REKTIFIZIERT - ESCUADRADO - КАЛИБРОВАННАЯ

I CLASSICI DI REX 	COLOR DECÒ WOOD BLACK	SURFACE MATTE	30x120 11 ^{4/5"} x47 ^{1/4"}	20x120 7 ^{7/8"} x47 ^{1/4"}	15x120 6"x47 ^{1/4"}	26,5x180 10 ^{3/7"} x70 ^{6/7"}	20x180 7 ^{7/8"} x70 ^{6/7"}
			748507 ■ FL-09300	748510 ■ FL-09300	748513 ■ FL-09300	748521 ■ FL-12400	748518 ■ FL-12400

I CLASSICI DI REX DECÒ WOOD	scatola - box			pallet		
	pz	mq	kg	box	mq	kg
30x120	3	1,08	24,00	20	21,60	500
20x120	6	1,44	31,40	24	34,56	780
15x120	6	1,08	24,00	32	34,56	790
26,5x180	3	1,44	34,20	39	56,16	1390
20x180	4	1,44	34,20	40	57,60	1420

Luxury design



LUXURY DESIGN / REX / 71

I CLASSICI DI REX

STATUARIO

OPEN BOOK SOFT A+B 320x320 (126"x126") (9000160) ■ FL-15600

OPEN BOOK GLOSSY A+B 320x320 (126"x126") (9000161) ■ FL-18800

Es. posa A



160x320 (63"x126")
OPEN BOOK A SOFT
OPEN BOOK A GLOSSY

160x320 (63"x126")
OPEN BOOK B SOFT
OPEN BOOK B GLOSSY

Es. posa B

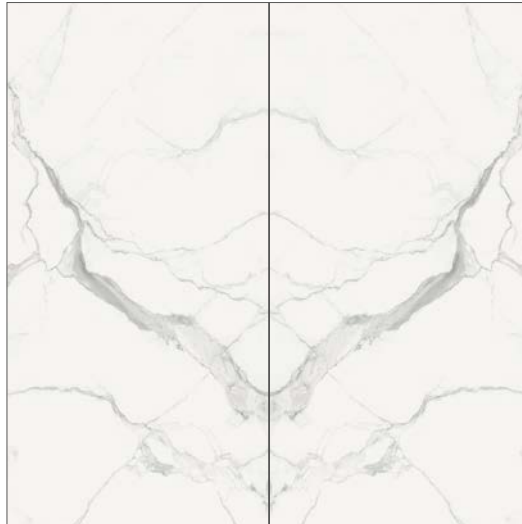

Es. posa C

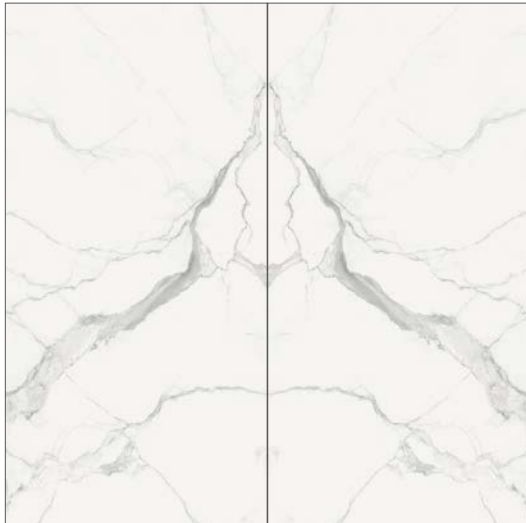

Es. posa D

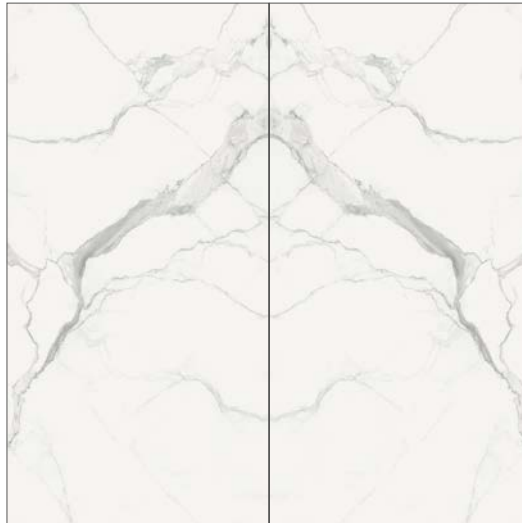

Il disegno riprodotto è indicativo.

Come per il materiale naturale anche la grafica di OPEN BOOK e CHAIN può mostrare discontinuità di vena nel passaggio da una lastra all'altra. Per questo motivo differenze fino a 1,5 cm devono essere considerate come caratteristica del prodotto.

The drawing is purely illustrative.

As with the natural material, the graphic design of OPEN BOOK and CHAIN may result in discontinuities in the veining between panels. Discontinuities of up to 1.5 cm are not defects, but are characteristic of the product.

Le dessin reproduit est indicatif.

De même que le matériau naturel, le graphisme d'OPEN BOOK et de CHAIN peut présenter des marbrures discontinues d'une dalle à l'autre. Pour cette raison, les différences jusqu'à 1,5 cm doivent être considérées comme une caractéristique du produit.

Die wiedergegebene Zeichnung ist eine Musterzeichnung.

Wie für das natürliche Material kann auch die Grafik von OPEN BOOK und CHAIN Brüche der Aderungen beim Übergang von einer Platte zur andern aufweisen. Aus diesem Grund sind Unterschiede bis zu 1,5 cm als Charakteristik des Produkts zu betrachten.

El dibujo es indicativo.

Como el material natural, también la gráfica de OPEN BOOK y CHAIN puede mostrar discontinuidades de la veta al pasar de una losa a otra. Por este motivo, las diferencias de hasta 1,5 cm se deben considerar características del producto.

Воспроизведенный рисунок является приблизительным.

Как у натуральных материалов, графика OPEN BOOK и CHAIN может иметь отличия в рисунке при переходе от одной плиты к другой. По этой причине, несоответствия до 1,5 см должны рассматриваться как характерные свойства продукции.



STATUARIO

CHAIN SOFT A+B+C 360x240 (141^{3/4}"x94^{1/2}") (9000167) ■ FL-11300
 CHAIN GLOSSY A+B+C 360x240 (141^{3/4}"x94^{1/2}") (9000168) ■ FL-14000
 Es. posa A

STATUARIO

CHAIN SOFT D+E+F 360x240 (141^{3/4}"x94^{1/2}") (9000170) ■ FL-11300
 CHAIN GLOSSY D+E+F 360x240 (141^{3/4}"x94^{1/2}") (9000171) ■ FL-14000

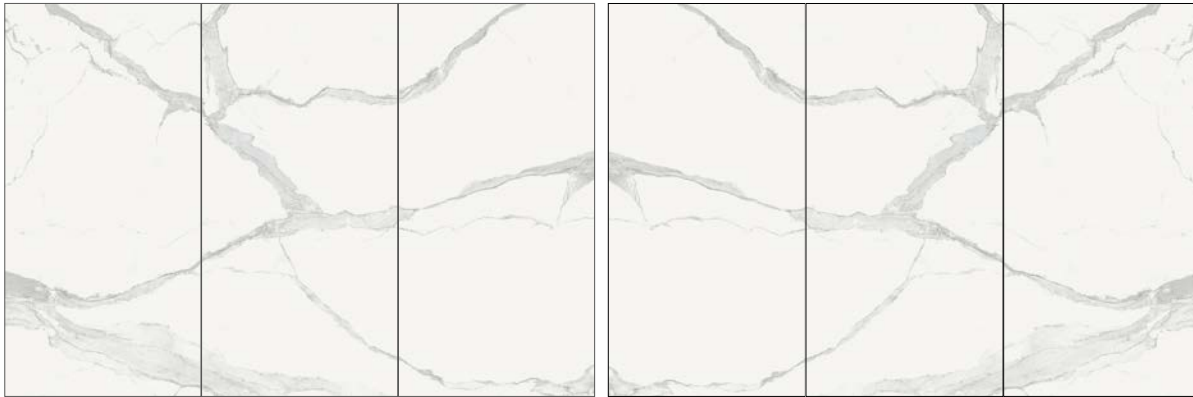

120x240 (47^{1/4}"x94^{1/2}")
 CHAIN A SOFT
 CHAIN A GLOSSY

120x240 (47^{1/4}"x94^{1/2}")
 CHAIN B SOFT
 CHAIN B GLOSSY

120x240 (47^{1/4}"x94^{1/2}")
 CHAIN C SOFT
 CHAIN C GLOSSY

120x240 (47^{1/4}"x94^{1/2}")
 CHAIN D SOFT
 CHAIN D GLOSSY

120x240 (47^{1/4}"x94^{1/2}")
 CHAIN E SOFT
 CHAIN E GLOSSY

120x240 (47^{1/4}"x94^{1/2}")
 CHAIN F SOFT
 CHAIN F GLOSSY

Es. posa B

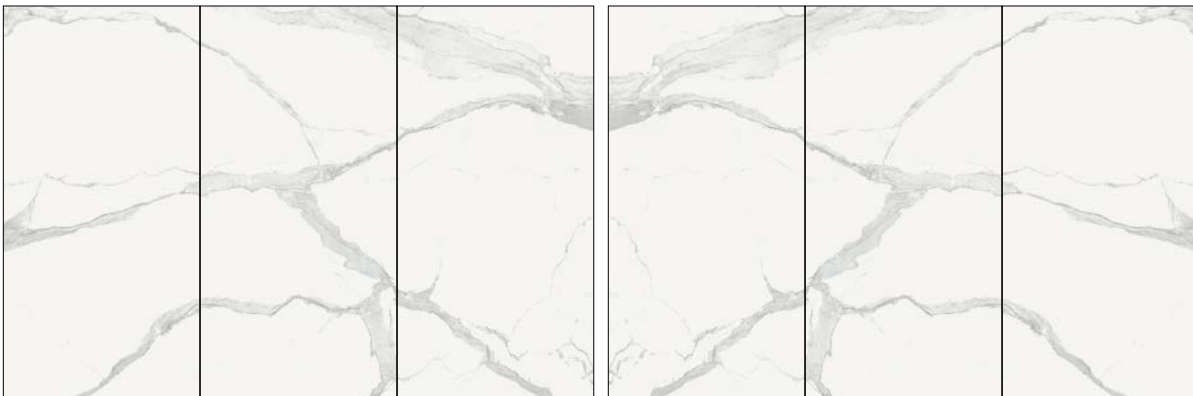

120x240 (47^{1/4}"x94^{1/2}")
 CHAIN C SOFT
 CHAIN C GLOSSY

120x240 (47^{1/4}"x94^{1/2}")
 CHAIN B SOFT
 CHAIN B GLOSSY

120x240 (47^{1/4}"x94^{1/2}")
 CHAIN A SOFT
 CHAIN A GLOSSY

120x240 (47^{1/4}"x94^{1/2}")
 CHAIN F SOFT
 CHAIN F GLOSSY

120x240 (47^{1/4}"x94^{1/2}")
 CHAIN E SOFT
 CHAIN E GLOSSY

120x240 (47^{1/4}"x94^{1/2}")
 CHAIN D SOFT
 CHAIN D GLOSSY



I CLASSICI DI REX

CALACATTA GOLD

OPEN BOOK MATTE A+B 320x320 (126"x126") (9000191) ■ FL-15600

OPEN BOOK GLOSSY A+B 320x320 (126"x126") (9000176) ■ FL-18800

Es. posa A



160x320 (63"x126")
OPEN BOOK A MATTE
OPEN BOOK A GLOSSY

160x320 (63"x126")
OPEN BOOK B MATTE
OPEN BOOK B GLOSSY

Es. posa B



Il disegno riprodotto è indicativo.

Come per il materiale naturale anche la grafica di OPEN BOOK e CHAIN può mostrare discontinuità di vena nel passaggio da una lastra all'altra. Per questo motivo differenze fino a 1,5 cm devono essere considerate come caratteristica del prodotto.

The drawing is purely illustrative.

As with the natural material, the graphic design of OPEN BOOK and CHAIN may result in discontinuities in the veining between panels. Discontinuities of up to 1.5 cm are not defects, but are characteristic of the product.

Le dessin reproduit est indicatif.

De même que le matériau naturel, le graphisme d'OPEN BOOK et de CHAIN peut présenter des marbrures discontinues d'une dalle à l'autre. Pour cette raison, les différences jusqu'à 1,5 cm doivent être considérées comme une caractéristique du produit.

Die wiedergegebene Zeichnung ist eine Musterzeichnung.

Wie für das natürliche Material kann auch die Grafik von OPEN BOOK und CHAIN Brüche der Aderungen beim Übergang von einer Platte zur andern aufweisen. Aus diesem Grund sind Unterschiede bis zu 1,5 cm als Charakteristik des Produkts zu betrachten.

El dibujo es indicativo.

Como el material natural, también la gráfica de OPEN BOOK y CHAIN puede mostrar discontinuidades de la veta al pasar de una losa a otra. Por este motivo, las diferencias de hasta 1,5 cm se deben considerar características del producto.

Воспроизведенный рисунок является приблизительным.

Как у натуральных материалов, графика OPEN BOOK и CHAIN может иметь отличия в рисунке при переходе от одной плиты к другой. По этой причине, несовпадения до 1,5 см должны рассматриваться как характерные свойства продукции.



CALACATTA GOLD

CHAIN MATTE A+B+C 360x240 (141^{3/4"}x94^{1/2"}) (9000188) ■ FL-11300
 CHAIN GLOSSY A+B+C 360x240 (141^{3/4"}x94^{1/2"}) (9000179) ■ FL-14000
 Es. posa A

CALACATTA GOLD

CHAIN MATTE F+E+D 360x240 (141^{3/4"}x94^{1/2"}) (9000189) ■ FL-11300
 CHAIN GLOSSY F+E+D 360x240 (141^{3/4"}x94^{1/2"}) (9000180) ■ FL-14000

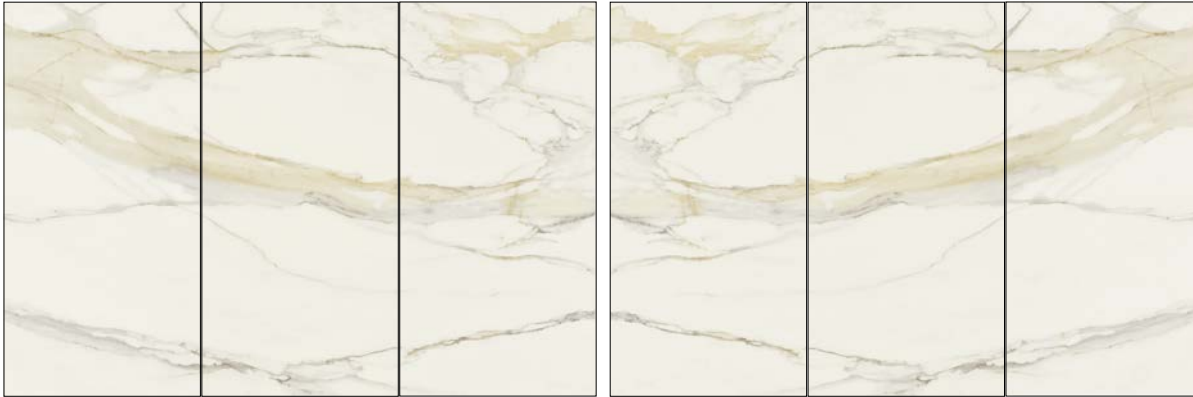

120x240 (47^{1/8"}x94^{1/2"})
 CHAIN A MATTE
 CHAIN A GLOSSY

120x240 (47^{1/8"}x94^{1/2"})
 CHAIN B MATTE
 CHAIN B GLOSSY

120x240 (47^{1/8"}x94^{1/2"})
 CHAIN C MATTE
 CHAIN C GLOSSY

120x240 (47^{1/8"}x94^{1/2"})
 CHAIN F MATTE
 CHAIN F GLOSSY

120x240 (47^{1/8"}x94^{1/2"})
 CHAIN E MATTE
 CHAIN E GLOSSY

120x240 (47^{1/8"}x94^{1/2"})
 CHAIN D MATTE
 CHAIN D GLOSSY

Es. posa B

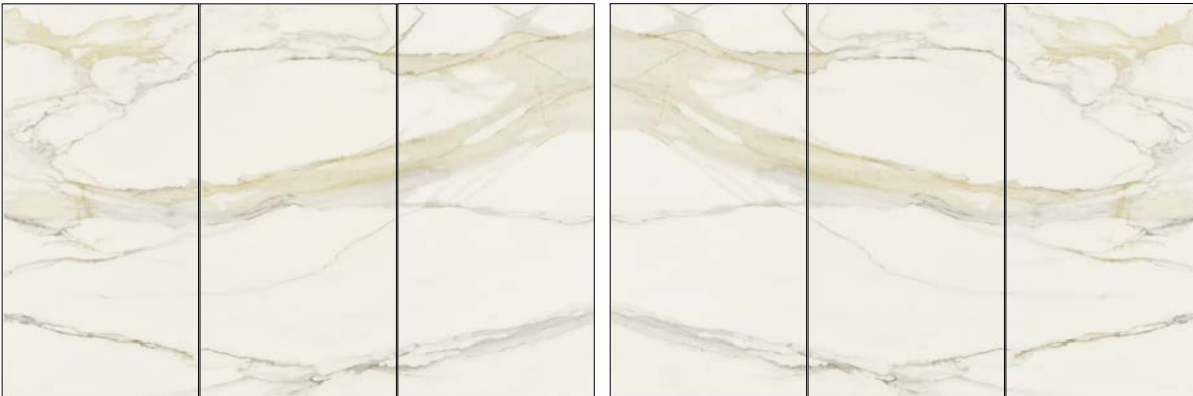

120x240 (47^{1/8"}x94^{1/2"})
 CHAIN F MATTE
 CHAIN F GLOSSY

120x240 (47^{1/8"}x94^{1/2"})
 CHAIN E MATTE
 CHAIN E GLOSSY

120x240 (47^{1/8"}x94^{1/2"})
 CHAIN D MATTE
 CHAIN D GLOSSY









120x240 (47^{1/8"}x94^{1/2"})
 CHAIN A MATTE
 CHAIN A GLOSSY

120x240 (47^{1/8"}x94^{1/2"})
 CHAIN B MATTE
 CHAIN B GLOSSY

120x240 (47^{1/8"}x94^{1/2"})
 CHAIN C MATTE
 CHAIN C GLOSSY

I CLASSICI DI REX

PEZZI SPECIALI/SPECIAL TRIMS/PIÈCES SPÉCIALES
FORMSTÜCKE/PIEZAS ESPECIALES/Специальные изделия

10 mm 3/8" ↑ ↓		COLOR	SURFACE	30x30 11 ^{4/5"} x11 ^{4/5"}  mosaico tessere 3x15 pz/box 11	30x30 11 ^{4/5"} x11 ^{4/5"}  mosaico 3D tessere 3x3 pz/box 9	4,6x60 1 ^{4/5"} x23 ^{5/8"}  battiscopa	33x120x3 13 ^{3/4"} x47 ^{1/4"} x1 ^{1/8"}  gradino pz/box 2
I CLASSICI DI REX		STATUARIO	GLOSSY	748340 ▲ FL-02200	748341 ▲ FL-04900	748343 ◆ FL-01600	748345 ▲ FL-22600
			SOFT	748339 ▲ FL-02100		748342 ◆ FL-01600	748344 ▲ FL-20400
		CALACATTA GOLD	GLOSSY	750721 ▲ FL-02200	750710 ▲ FL-04900	750722 ◆ FL-01600	750723 ▲ FL-22600
			MATTE	753299 ▲ FL-02100		753300 ◆ FL-01600	753301 ▲ FL-20400
		MARQUINIA	GLOSSY	750879 ▲ FL-02200	750880 ▲ FL-04900	750881 ◆ FL-01600	750882 ▲ FL-22600
		MATTE	751918 ▲ FL-01700		751919 ◆ FL-01600	751920 ▲ FL-20400	
	BRAZILIAN	GLOSSY	750903 ▲ FL-02200	750902 ▲ FL-04900	750918 ◆ FL-01600	750919 ▲ FL-22600	
	PORTORO	GLOSSY	750917 ▲ FL-02200	750916 ▲ FL-04900	750920 ◆ FL-01600	750921 ▲ FL-22600	





10 mm 3/8" ↑ ↓		COLOR	SURFACE	4,6x60 1 ^{4/5"} x23 ^{5/8"}  battiscopa
I CLASSICI DI REX		DECÒ WOOD WHITE	MATTE	750062 ◆ FL-01600
		DECÒ WOOD PEARL	MATTE	750063 ◆ FL-01600
		DECÒ WOOD BLACK	MATTE	750064 ◆ FL-01600

Nelle operazioni di posa a listoni sfalsati, si raccomanda sempre di fare in modo che il lato maggiore della piastrella termini a circa un terzo della lunghezza di quelle accanto (posa sfalsata "a 1/3"). - When installing staggered strips, we recommend that the tile's longer side should always end at about one-third of the length of the tiles next to it ("1/3" staggered installation). - Lors de la pose des listels décalés, il faut toujours faire en sorte que le côté le plus grand du carreau se trouve à environ 1/3 de la longueur des carreaux d'à côté (pose décalée "à 1/3"). - Beim Verlegen der Leisten in versetzter Form ist zu beachten, dass die höhere Seite der Fliese immer circa bei einem Drittels der Länge der sich daneben befindlichen Fliesen abschließt ("Um 1/3" versetzte Verlegung). - En las operaciones de colocación de listones escalonados, se recomienda hacerlo siempre de forma tal que el lado mayor del azulejo termine teniendo alrededor de un tercio de la longitud de los contiguos (colocación escalonada "a 1/3"). - При укладке зигзагом следите за тем, чтобы более длинный край плиток заканчивался примерно на 1/3 длины соседних плиток (укладка зигзагом «1/3»).

Per un effetto ottimale della posa, florim suggerisce di mantenere 2 mm di fuga per pose monoformato e 3 mm per combinare formati misti. - For optimal installation results, florim recommends maintaining a joint of 2 mm 1/12" for single format installations and 3 mm 1/8" to combine mixed formats. - Pour réaliser une pose parfaite, florim suggère de maintenir 2 mm de joint pour la pose des monoformats, et 3 mm pour les combinaisons de formats mixtes. - Um einen optimalen effekt beim verlegen zu erzielen empfiehlt florim eine 2 mm fuge bei einformatigen verlegungen und 3 mm fuge bei formatkombinationen Para lograr los máximos resultados en la posa del producto, florim aconseja 2 mm de junta en aplicaciones monoformato y 3 mm en combinaciones de formatos mixtos - **ДЛЯ ОПТИМАЛЬНОЙ УКЛАДКИ * FLORIM * РЕКОМЕНДУЕТ ВЫДЕРЖИВАТЬ ЗАЗОР 2 ММ ДЛЯ МОНОФОРМАТА И 3 ММ ПРИ СМЕШАННЫХ ФОРМАТАХ.**

I CLASSICI DI REX	scatola - box			pallet		
	pz	mq	kg	box	mq	kg
80x180	2	2,88	67,20	20	57,60	1400
60x120	2	1,44	31,70	30	43,20	980
30x120	3	1,08	23,80	20	21,60	500
80x80	2	1,28	29,80	40	51,20	1220
60x60	3	1,08	23,80	40	43,20	980
30x60	6	1,08	24,10	40	43,20	990

I CLASSICI DI REX	scatola - box			pallet		
	pz	ml	kg	box	mq	kg
4,6x60 battiscopa	14	8,40	8,40	-	-	-

6 mm 1/4" ↑↓				30x30 11 4/5" x 11 4/5"	30x30 11 4/5" x 11 4/5"
	COLOR		SURFACE	 mosaico tessere 7,5x7,5 pz/box 11	 muretto tessere 7,5x15 pz/box 11
I CLASSICI DI REX		STATUARIO	GLOSSY	747773 ▲ FL-02100	747803 ▲ FL-02100
			SOFT	747772 ▲ FL-01800	747802 ▲ FL-01800
		CALACATTA GOLD	GLOSSY	750869 ▲ FL-02100	750871 ▲ FL-02100
			MATTE	753302 ▲ FL-01800	753303 ▲ FL-01800
		MARQUINIA	GLOSSY	750887 ▲ FL-02100	750888 ▲ FL-02100
			MATTE	751925 ▲ FL-01800	751927 ▲ FL-01800

PEZZI SPECIALI/SPECIAL TRIMS/PIÈCES SPÉCIALES/FORMSTÜCKE/PIEZAS ESPECIALES/Специальные изделия

6 mm 1/4" ↑↓				4,6x80 1 4/5" x 3 1/2"
	COLOR		SURFACE	 battiscopa
I CLASSICI DI REX		STATUARIO	GLOSSY	747888 ◆ FL-01800
			SOFT	747887 ◆ FL-01800
		CALACATTA GOLD	GLOSSY	750873 ◆ FL-01800
			MATTE	753304 ◆ FL-01800
		MARQUINIA	GLOSSY	750889 ◆ FL-01800
			MATTE	751928 ◆ FL-01800

In relazione alle differenti tecnologie produttive l'accostamento di prodotti con spessori diversi potrebbe presentare delle disomogeneità, se ne sconsiglia pertanto l'abbinamento. / Due to the different production technologies, contiguous installation of products with different thickness may give a non-homogeneous result. For this reason we do not recommend this option. / Vu que différentes technologies de production sont utilisées avec des épaisseurs différentes, des problèmes d'homogénéité pourraient se présenter, il est donc déconseillé de les poser ensemble. / Wegen unterschiedlicher Produktionstechnologien können die Fliesen mit verschiedenen Materialstärken optische Differenzen aufweisen. Von einem direkten Aneinanderlegen wird deshalb abgeraten. / Dadas las diferentes tecnologías productivas, la combinación de productos de diferentes espesores podría dar lugar a heterogeneidad, por lo que se desaconseja mezclarlas. / В связи с различием в технологиях производства, сочетание продукции разной толщины иногда может представлять неоднородность материала. Такие сочетания следует избегать.

FLOHM OVERSIZE
magnum

160x320/120x280/160x160/120x240/120x120/60x120

Specifica Imballo pag.
Packaging specifications on page
Spécifications d'emballage à page
Verpackungsdetail Seite
Especificaciones de embalaje a la página
Информация об упаковке на стр.
200/201



I FILATI DI REX

gres porcellanato decorato
decorated porcelain tiles
grès cérame décoré
verziertes feinsteinzeug
gres porcelánico decorado
ДЕКОРИРОВАННЫЙ КЕРАМОГРАНИТ

RUBELLI
design





I FILATI DI REX

“I Filati di Rex - Rubelli Design”, la nuova collezione ideata da Florim in collaborazione con Rubelli, aziende di riferimento italiane nel campo del design, sebbene di settori differenti, sono appassionate a tutto quello che fa rima con Arte e Bellezza. Si tratta di due realtà simili e, allo stesso tempo, profondamente diverse, capaci di tendersi la mano per dare vita ad un progetto unico che mette insieme l'ingegno e l'esperienza che appartengono alla cultura imprenditoriale italiana di qualità. Il prodotto ceramico rievoca il senso di artigianalità della secolare arte della seta attraverso lastre ceramiche di grande formato che si presentano come tessuti innovativi, seducenti alla vista e gradevoli al tatto, capaci di conservare intatta l'essenza e la preziosità di quelli artigianali.

“I Filati di Rex - Rubelli Design” is the new collection designed by Florim in collaboration with Rubelli. Italian key players in the field of design, although in different sectors, they are passionate about everything that rhymes with Art and Beauty. These two similar yet at the same time profoundly different companies have joined forces, giving life to a unique project that brings together the skill and experience that are hallmarks of high-quality Italian entrepreneurial culture. The ceramic product calls to mind the craftsmanship of the centuries-old art of silk-weaving, through large-size ceramic panels that resemble innovative fabrics, alluring to the eye and pleasing to the touch, able to preserve the very essence and fineness of hand-spun silk.

« I Filati di Rex - Rubelli Design », la nouvelle collection élaborée par Florim en collaboration avec Rubelli, des sociétés de référence dans le secteur du design, chacune avec un domaine de compétence différent, sont passionnées par tout ce qui rime avec Art et Beauté. Deux sociétés à la fois semblables et profondément différentes qui se tendent la main pour donner naissance à un projet unique combinant le génie et l'expérience, à savoir des caractéristiques typiques de la culture entrepreneuriale italienne de qualité. Le produit céramique évoque le caractère artisanal de l'art séculaire de la soie à travers des dalles céramiques grand format qui se présentent comme des tissus innovants, séduisants à l'œil et agréables au toucher, qui savent conserver intactes l'essence et la préciosité des tissus artisanaux.

„I Filati di Rex - Rubelli Design”, die neue Kollektion, die Florim in Zusammenarbeit mit Rubelli schuf. Zwei renommierte italienische Designunternehmen, die trotz ihrer verschiedenen Sektoren eine große Leidenschaft für alles hegen, was sich mit Kunst und Schönheit reimt. Es handelt sich um zwei ähnliche und zugleich zutiefst unterschiedliche Firmen, die sich zusammenschließen, um ein einzigartiges Projekt zu verwirklichen, das den Einfallsreichtum und die Erfahrung der hochwertigen Unternehmenskultur Italiens vereint. Das Keramikprodukt weckt die Erinnerung an den Handwerkssinn der jahrhundertealten Seidenkunst durch große Keramikplatten, die sich dem Auge als verführerische und zudem angenehm weiche Stoffe entpuppen, die das Wesen und die Kostbarkeit der handwerklich hergestellten Erzeugnisse voll aufbewahren.

“I Filati di Rex - Rubelli Design”, la nueva colección creada por Florim en colaboración con Rubelli, empresas italianas de referencia en el ámbito del diseño, aunque en sectores distintos, que sienten pasión por todo lo que rima con Arte y Belleza. Se trata de dos empresas parecidas y, al mismo tiempo, profundamente distintas, capaces de darse la mano para dar vida a un proyecto único que combina el ingenio y la experiencia característicos de la cultura empresarial italiana de calidad. El producto cerámico evoca el sentido de artesanía del arte secular de la seda a través de losas cerámicas de gran formato que se presentan como tejidos innovadores, seductores a la vista y agradables al tacto, capaces de conservar intacta la esencia y la belleza de los artesanales.

“I Filati di Rex - Rubelli Design” - новая коллекция, разработанная Florim в сотрудничестве с Rubelli, ведущими итальянскими компаниями в сфере дизайна, хоть и в разных отраслях, которые увлеченно работают со всем тем, что касается красоты и искусства. Это - две похожие друг на друга, но вместе с тем, совершенно разные компании, способные наладить взаимодействие для создания уникального проекта, объединяющего в себе человеческий гений и опыт высокой культуры итальянского предпринимательства. Эта керамическая продукция воскрешает чувство ремесленности многовекового искусства шелкопряжения посредством керамических плит большого формата, которые представляются как инновационные, обворожительные ткани на вид и приятные на ощупь, способные сохранить нетронутой сущность и ценность материалов ремесленного производства.

I FILATI DI REX

LADY HAMILTON VANIGLIA



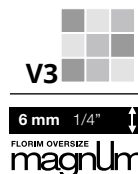
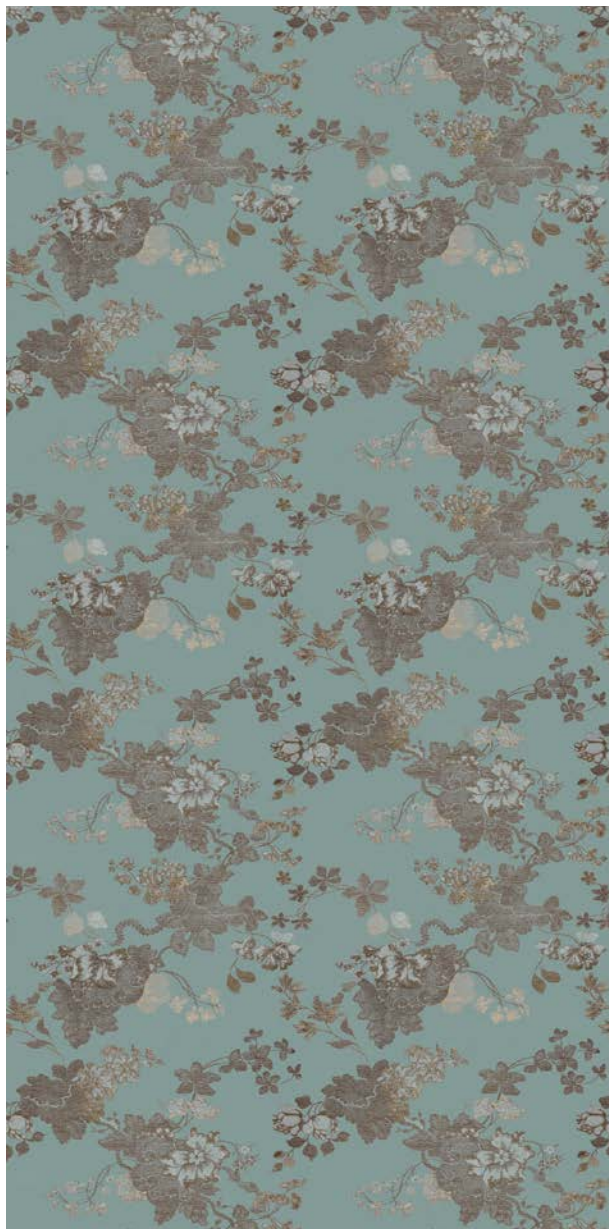

LADY HAMILTON TURCHESE



GRES PORCELLANATO DECORATO

DECORATED PORCELAIN TILES/GRES CÉRAMÉ DÉCORÉ/VERZIERTES FEINSTEINZEUG/GRES PORCELÁNICO DECORADO/ДЕКОРИРОВАННЫЙ КЕРАМОГРАНИТ
SQUADRATO - SQUARED - EQUARRI - REKTIFIZIERT - ESCUADRADO - КАЛИБРОВАННАЯ

		6 mm 1/4" ↑↓		COLOR	SURFACE	120x280 47 ^{11/16"} x110 ^{1/4"}	120x240 47 ^{11/16"} x94 ^{1/2"}	60x120 A 23 ^{5/8"} x47 ^{1/4"}	60x120 B 23 ^{5/8"} x47 ^{1/4"}	60x120 C 23 ^{5/8"} x47 ^{1/4"}	60x120 D 23 ^{5/8"} x47 ^{1/4"}	60x120 23 ^{5/8"} x47 ^{1/4"} A+B+C+D
I FILATI DI REX		LADY HAMILTON VANIGLIA	MATTE	767040 ■ FL-42900	767075 ■ FL-42900	767110 ■ FL-39700	769124 ■ FL-39700	769125 ■ FL-39700	769126 ■ FL-39700	9000202 ■ FL-39700		
		LADY HAMILTON TURCHESE	MATTE	767042 ■ FL-42900	767077 ■ FL-42900	767114 ■ FL-39700	769191 ■ FL-39700	769192 ■ FL-39700	769193 ■ FL-39700	9000203 ■ FL-39700		

RUBELLI
design

LADY HAMILTON CIPRIA



LADY HAMILTON AMARANTO

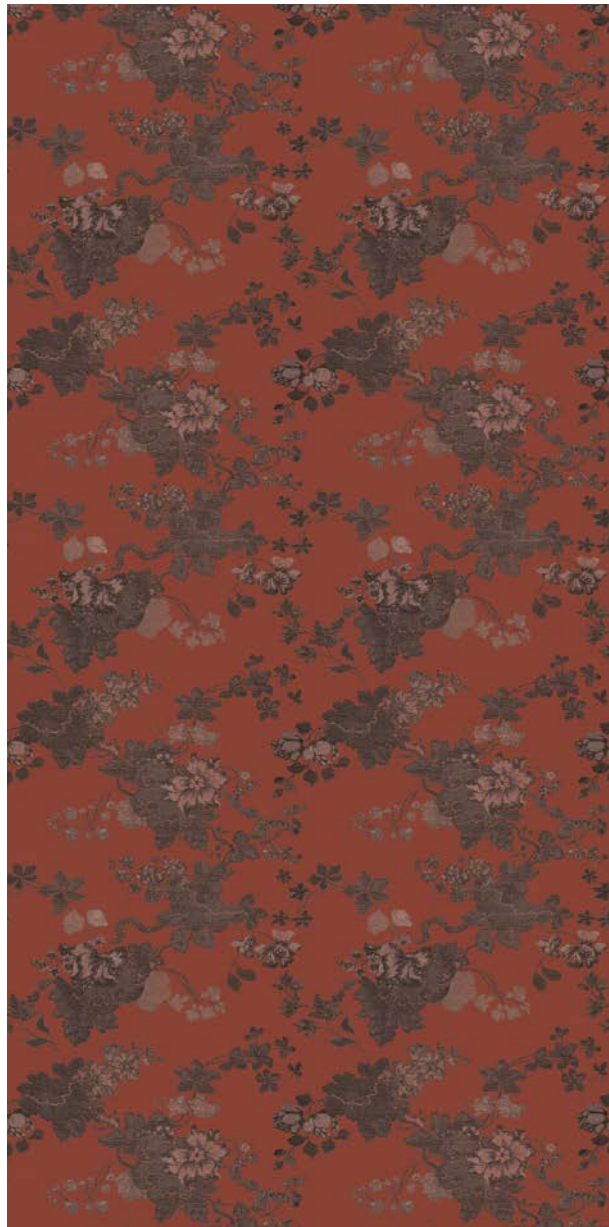

GRES PORCELLANATO DECORATO

DECORATED PORCELAIN TILES/GRES CÉRAME DÉCORÉ/VERZIERTES FEINSTEINZEUG/GRES PORCELÁNICO DECORADO/ДЕКОРИРОВАННЫЙ КЕРАМОГРАНИТ

SQUADRATO - SQUARED - EQUARRI - REKTIFIZIERT - ESCUADRADO - КАЛИБРОВАННАЯ

		6 mm 1/4" ↑↓		COLOR	SURFACE	120x280 47 ^{1/4"} x110 ^{1/4"}	120x240 47 ^{1/4"} x94 ^{1/2"}	60x120 A 23 ^{5/8"} x47 ^{1/4"}	60x120 B 23 ^{5/8"} x47 ^{1/4"}	60x120 C 23 ^{5/8"} x47 ^{1/4"}	60x120 D 23 ^{5/8"} x47 ^{1/4"}	60x120 23 ^{5/8"} x47 ^{1/4"} A+B+C+D
I FILATI DI REX		LADY HAMILTON CIPRIA	MATTE	767041 ■ FL-42900	767076 ■ FL-42900	767113 ■ FL-39700	769109 ■ FL-39700	769110 ■ FL-39700	769111 ■ FL-39700	9000204 ■ FL-39700		
		LADY HAMILTON AMARANTO	MATTE	767043 ■ FL-42900	767078 ■ FL-42900	767115 ■ FL-39700	769160 ■ FL-39700	769161 ■ FL-39700	769162 ■ FL-39700	9000205 ■ FL-39700		

I FILATI DI REX

FUNNY GIRL VANIGLIA





FUNNY GIRL TURCHESE



6 mm 1/4" ↑
FLORIM OVERSIZE
magnUm

GRES PORCELLANATO DECORATO

DECORATED PORCELAIN TILES/GRÈS CÉRAME DÉCORÉ/VERZIERTES FEINSTEINZEUG/GRES PORCELÁNICO DECORADO/ДЕКОРИРОВАННЫЙ КЕРАМОГРАНИТ
SQUADRATO - SQUARED - EQUARRI - REKTIFIZIERT - ESCUADRADO - КАЛИБРОВАННАЯ

		6 mm 1/4" ↑		COLOR	SURFACE	120x280 47 ^{11/16"} x110 ^{1/4"}	120x240 47 ^{11/16"} x94 ^{1/2"}	60x120 A 23 ^{5/8"} x47 ^{1/4"}	60x120 B 23 ^{5/8"} x47 ^{1/4"}	60x120 C 23 ^{5/8"} x47 ^{1/4"}	60x120 D 23 ^{5/8"} x47 ^{1/4"}	60x120 23 ^{5/8"} x47 ^{1/4"} A+B+C+D
I FILATI DI REX		FUNNY GIRL VANIGLIA	MATTE	767044 ■ FL-42900	767079 ■ FL-42900	767116 ■ FL-39700	769118 ■ FL-39700	769119 ■ FL-39700	769120 ■ FL-39700	9000206 ■ FL-39700		
		FUNNY GIRL TURCHESE	MATTE	767046 ■ FL-42900	767081 ■ FL-42900	767118 ■ FL-39700	769188 ■ FL-39700	769189 ■ FL-39700	769190 ■ FL-39700	9000207 ■ FL-39700		

RUBELLI
design

FUNNY GIRL CIPRIA



FUNNY GIRL GRANATA



GRES PORCELLANATO DECORATO
 DECORATED PORCELAIN TILES/GRES CÉRAMÉ DÉCORÉ/VERZIERTES FEINSTEINZEUG/GRES PORCELÁNICO DECORADO/ДЕКОРИРОВАННЫЙ КЕРАМОГРАНИТ
 SQUADRATO - SQUARED - EQUARRI - REKTIFIZIERT - ESCUADRADO - КАЛИБРОВАННАЯ

6 mm 1/4" ↑↓		COLOR	SURFACE	120x280 47 ^{1/4"} x110 ^{1/4"}	120x240 47 ^{1/4"} x94 ^{1/2"}	60x120 A 23 ^{5/8"} x47 ^{1/4"}	60x120 B 23 ^{5/8"} x47 ^{1/4"}	60x120 C 23 ^{5/8"} x47 ^{1/4"}	60x120 D 23 ^{5/8"} x47 ^{1/4"}	60x120 23 ^{5/8"} x47 ^{1/4"} A+B+C+D
I FILATI DI REX		FUNNY GIRL CIPRIA	MATTE	767045 ■ FL-42900	767080 ■ FL-42900	767117 ■ FL-39700	769103 ■ FL-39700	769104 ■ FL-39700	769105 ■ FL-39700	9000208 ■ FL-39700
		FUNNY GIRL GRANATA	MATTE	767048 ■ FL-42900	767083 ■ FL-42900	767120 ■ FL-39700	769175 ■ FL-39700	769176 ■ FL-39700	769177 ■ FL-39700	9000209 ■ FL-39700

RUBELLI
design

I FILATI DI REX

DORIAN GRAY RUGIADA



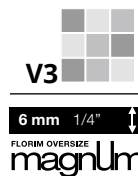

DORIAN GRAY FIORDALISO



GRES PORCELLANATO DECORATO

DECORATED PORCELAIN TILES / GRÈS CÉRAME DÉCORÉ / VERZIERTES FEINSTEINZEUG / GRES PORCELÁNICO DECORADO / ДЕКОРИРОВАННЫЙ КЕРАМОГРАНИТ

SQUADRATO - SQUARED - EQUARRI - REKTIFIZIERT - ESCUADRADO - КАЛИБРОВАННАЯ

		6 mm 1/4" ↑↓		COLOR	SURFACE	120x280 47 ^{11/16"} x110 ^{1/4"}	120x240 47 ^{11/16"} x94 ^{1/2"}	60x120 A 23 ^{5/8"} x47 ^{1/4"}	60x120 B 23 ^{5/8"} x47 ^{1/4"}	60x120 C 23 ^{5/8"} x47 ^{1/4"}	60x120 D 23 ^{5/8"} x47 ^{1/4"}	60x120 23 ^{5/8"} x47 ^{1/4"} A+B+C+D
I FILATI DI REX		DORIAN GRAY RUGIADA	MATTE	767049 ■ FL-42900	767084 ■ FL-42900	767121 ■ FL-39700	769097 ■ FL-39700	769098 ■ FL-39700	769099 ■ FL-39700	9000210 ■ FL-39700		
		DORIAN GRAY FIORDALISO	MATTE	767051 ■ FL-42900	767086 ■ FL-42900	767123 ■ FL-39700	769203 ■ FL-39700	769204 ■ FL-39700	769205 ■ FL-39700	9000211 ■ FL-39700		

RUBELLI
design

DORIAN GRAY GLICINE

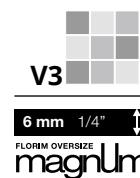

GRES PORCELLANATO DECORATO

DECORATED PORCELAIN TILES/GRES CÉRAME DÉCORÉ/VERZIERTES FEINSTEINZEUG/GRES PORCELÁNICO DECORADO/ДЕКОРИРОВАННЫЙ КЕРАМОГРАНИТ

SQUADRATO - SQUARED - EQUARRI - REKTIFIZIERT - ESCUADRADO - КАЛИБРОВАННАЯ

6 mm 1/4" ↑↓	COLOR	SURFACE	120x280 47 ^{1/4"} x110 ^{1/4"}	120x240 47 ^{1/4"} x94 ^{1/2"}	60x120 A 23 ^{5/8"} x47 ^{1/4"}	60x120 B 23 ^{5/8"} x47 ^{1/4"}	60x120 C 23 ^{5/8"} x47 ^{1/4"}	60x120 D 23 ^{5/8"} x47 ^{1/4"}	60x120 23 ^{5/8"} x47 ^{1/4"} A+B+C+D
I FILATI DI REX	 DORIAN GRAY GLICINE	MATTE	767050 ■ FL-42900	767085 ■ FL-42900	767122 ■ FL-39700	769151 ■ FL-39700	769152 ■ FL-39700	769153 ■ FL-39700	9000212 ■ FL-39700

RUBELLI
design

I FILATI DI REX

GOLDFINGER RUGIADA



GOLDFINGER ACQUAMARINA





6 mm 1/4" ↑↓

FLORIM OVERSIZE
magnUm

GRES PORCELLANATO DECORATO

DECORATED PORCELAIN TILES / GRÈS CÉRAMÉ DÉCORÉ / VERZIERTES FEINSTEINZEUG / GRES PORCELÁNICO DECORADO / ДЕКОРИРОВАННЫЙ КЕРАМОГРАНИТ
SQUADRATO - SQUARED - EQUARRI - REKTIFIZIERT - ESCUADRADO - КАЛИБРОВАННАЯ

		6 mm 1/4" ↑↓									
		COLOR	SURFACE	120x280 47 ^{11/16"} x110 ^{1/4"}	120x240 47 ^{1/4"} x94 ^{1/2"}	60x120 A 23 ^{5/8"} x47 ^{1/4"}	60x120 B 23 ^{5/8"} x47 ^{1/4"}	60x120 C 23 ^{5/8"} x47 ^{1/4"}	60x120 D 23 ^{5/8"} x47 ^{1/4"}	60x120 23 ^{5/8"} x47 ^{1/4"} A+B+C+D	
I FILATI DI REX		GOLDFINGER RUGIADA	MATTE	767064 ■ FL-42900	767099 ■ FL-42900	767136 ■ FL-39700	769100 ■ FL-39700	769101 ■ FL-39700	769102 ■ FL-39700	9000213 ■ FL-39700	
		GOLDFINGER ACQUAMARINA	MATTE	767066 ■ FL-42900	767101 ■ FL-42900	767138 ■ FL-39700	769185 ■ FL-39700	769186 ■ FL-39700	769187 ■ FL-39700	9000214 ■ FL-39700	

RUBELLI
design

GOLDFINGER GLICINE

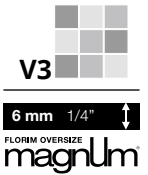
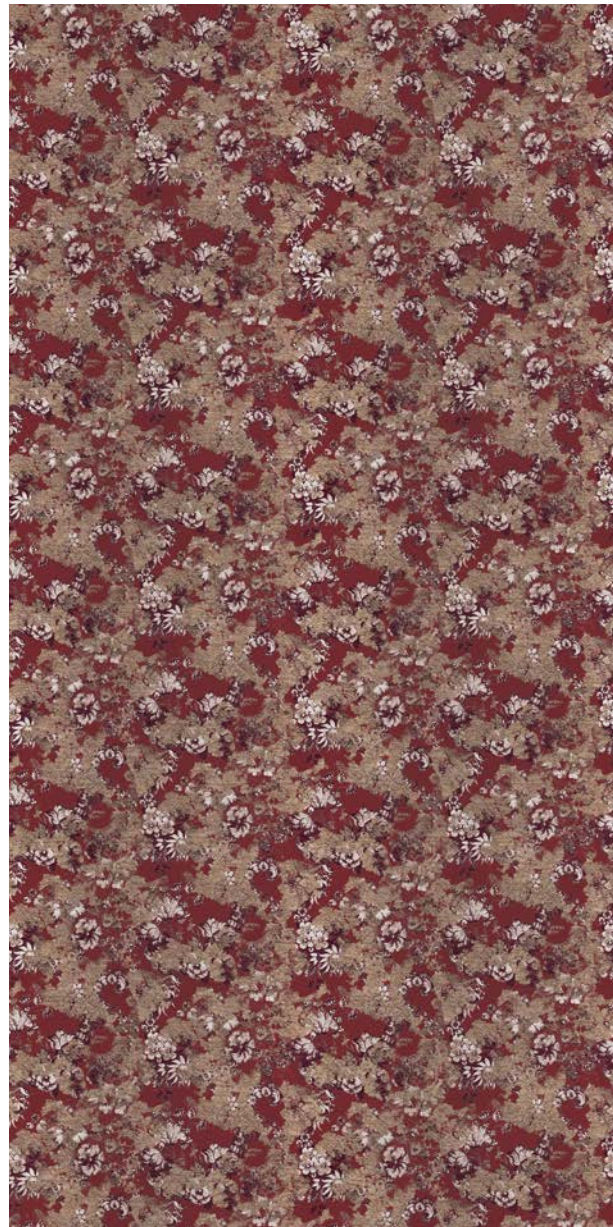

GOLDFINGER GRANATA



GRES PORCELLANATO DECORATO

DECORATED PORCELAIN TILES/GRÉS CÉRAMÉ DÉCORÉ/VERZIERTES FEINSTEINZEUG/GRES PORCELÁNICO DECORADO/ДЕКОРИРОВАННЫЙ КЕРАМОГРАНИТ

SQUADRATO - SQUARED - EQUARRI - REKTIFIZIERT - ESCUADRADO - КАЛИБРОВАННАЯ

		6 mm 1/4" ↑↓		COLOR	SURFACE	120x280 47 ^{1/4"} x110 ^{1/4"}	120x240 47 ^{1/4"} x94 ^{1/2"}	60x120 A 23 ^{5/8"} x47 ^{1/4"}	60x120 B 23 ^{5/8"} x47 ^{1/4"}	60x120 C 23 ^{5/8"} x47 ^{1/4"}	60x120 D 23 ^{5/8"} x47 ^{1/4"}	60x120 23 ^{5/8"} x47 ^{1/4"} A+B+C+D
I FILATI DI REX		GOLDFINGER GLICINE	MATTE	767065 ■ FL-42900	767100 ■ FL-42900	767137 ■ FL-39700	769154 ■ FL-39700	769155 ■ FL-39700	769156 ■ FL-39700	9000215 ■ FL-39700		
		GOLDFINGER GRANATA	MATTE	767067 ■ FL-42900	767102 ■ FL-42900	767139 ■ FL-39700	769178 ■ FL-39700	769179 ■ FL-39700	769181 ■ FL-39700	9000216 ■ FL-39700		

I FILATI DI REX

BESTEGUI AVORIO ANTICO

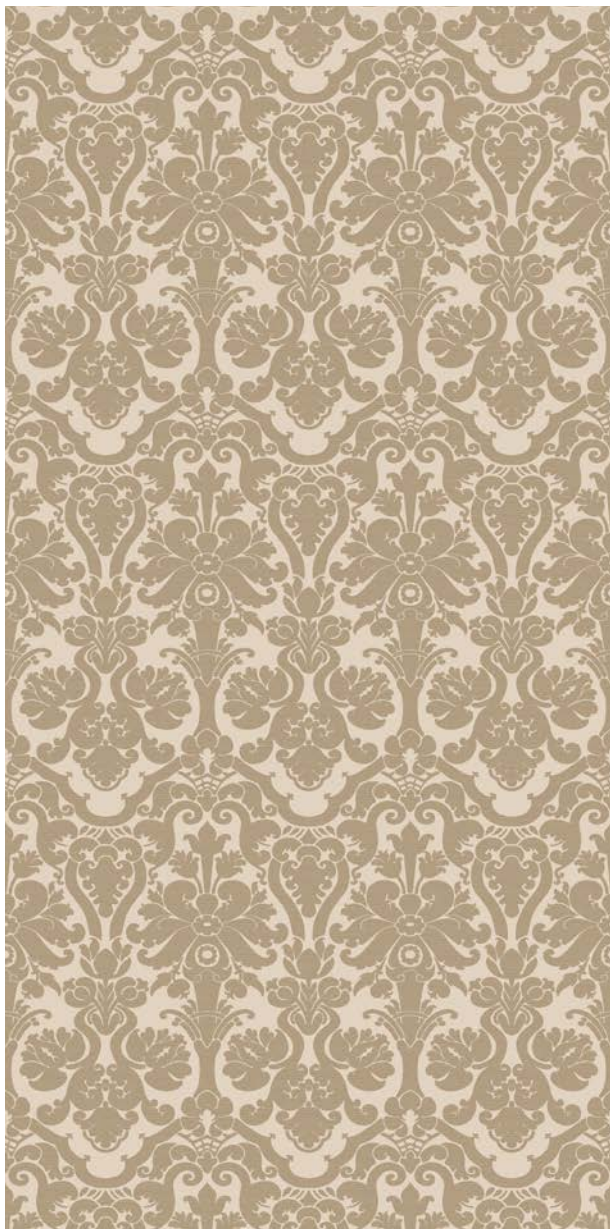

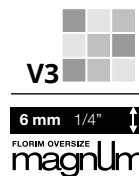

BESTEGUI AMBRA



GRES PORCELLANATO DECORATO

DECORATED PORCELAIN TILES/GRÈS CÉRAME DÉCORÉ/VERZIERTES FEINSTEINZEUG/GRES PORCELÁNICO DECORADO/ДЕКОРИРОВАННЫЙ КЕРАМОГРАНИТ

SQUADRATO - SQUARED - EQUARRI - REKTIFIZIERT - ESCUADRADO - КАЛИБРОВАННАЯ

		6 mm 1/4" ↑↓		COLOR	SURFACE	120x280 47 ^{11/16"} x110 ^{1/4"}	120x240 47 ^{11/16"} x94 ^{1/2"}	60x120 A 23 ^{5/8"} x47 ^{1/4"}	60x120 B 23 ^{5/8"} x47 ^{1/4"}	60x120 C 23 ^{5/8"} x47 ^{1/4"}	60x120 D 23 ^{5/8"} x47 ^{1/4"}	60x120 23 ^{5/8"} x47 ^{1/4"} A+B+C+D
I FILATI DI REX		BESTEGUI AVORIO ANTICO	MATTE	767052 ■ FL-42900	767087 ■ FL-42900	767124 ■ FL-39700	769087 ■ FL-39700	769089 ■ FL-39700	769090 ■ FL-39700	9000217 ■ FL-39700		
		BESTEGUI AMBRA	MATTE	767053 ■ FL-42900	767088 ■ FL-42900	767125 ■ FL-39700	769133 ■ FL-39700	769134 ■ FL-39700	769135 ■ FL-39700	9000218 ■ FL-39700		

RUBELLI
design

BESTEGUI GRANATA

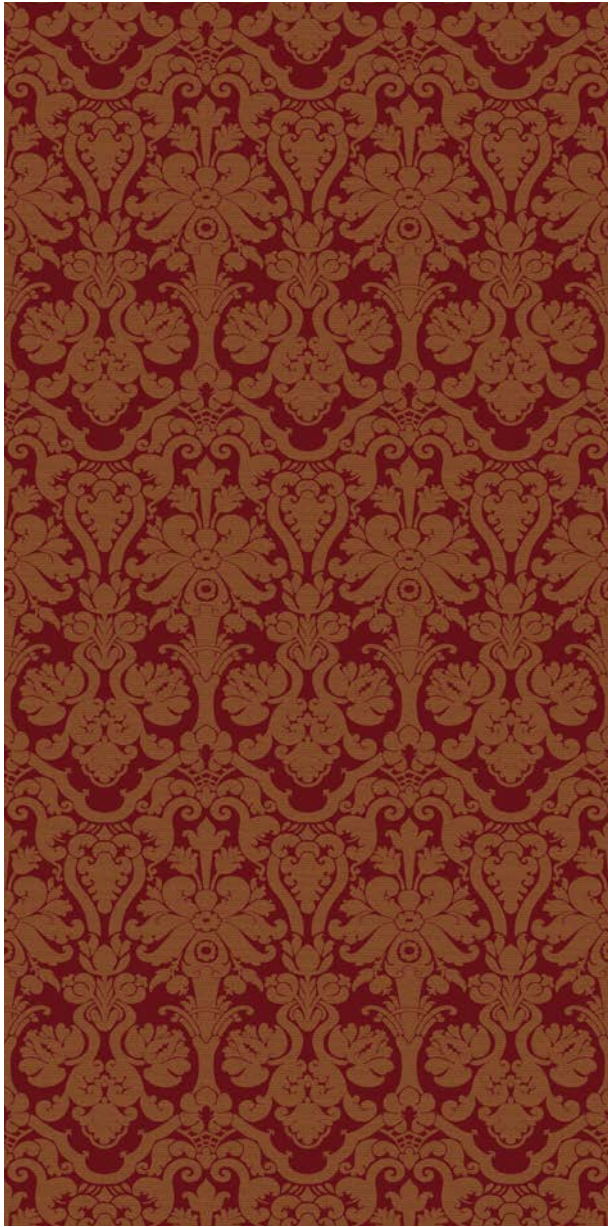

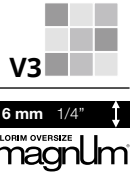
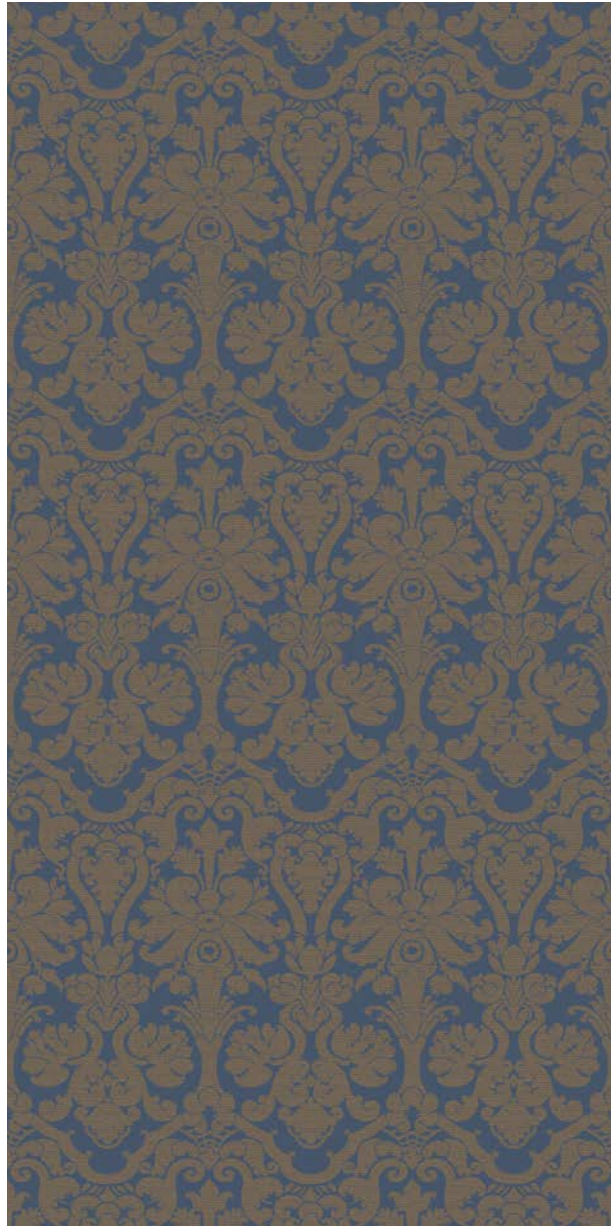

BESTEGUI BLU DI PRUSSIA



GRES PORCELLANATO DECORATO

DECORATED PORCELAIN TILES/GRES CÉRAMÉ DÉCORÉ/VERZIERTES FEINSTEINZEUG/GRES PORCELÁNICO DECORADO/ДЕКОРИРОВАННЫЙ КЕРАМОГРАНИТ

SQUADRATO - SQUARED - EQUARRI - REKTIFIZIERT - ESCUADRADO - КАЛИБРОВАННАЯ

		6 mm 1/4" ↑↓		COLOR	SURFACE	120x280 47 ^{1/4"} x110 ^{1/4"}	120x240 47 ^{1/4"} x94 ^{1/2"}	60x120 A 23 ^{5/8"} x47 ^{1/4"}	60x120 B 23 ^{5/8"} x47 ^{1/4"}	60x120 C 23 ^{5/8"} x47 ^{1/4"}	60x120 D 23 ^{5/8"} x47 ^{1/4"}	60x120 23 ^{5/8"} x47 ^{1/4"} A+B+C+D
I FILATI DI REX		BESTEGUI GRANATA	MATTE	767054 ■ FL-42900	767089 ■ FL-42900	767126 ■ FL-39700	769169 ■ FL-39700	769170 ■ FL-39700	769171 ■ FL-39700	9000219 ■ FL-39700		
		BESTEGUI BLU DI PRUSSIA	MATTE	767055 ■ FL-42900	767090 ■ FL-42900	767127 ■ FL-39700	769194 ■ FL-39700	769195 ■ FL-39700	769196 ■ FL-39700	9000220 ■ FL-39700		

RUBELLI
design

I FILATI DI REX

SAN MARCO AVORIO ANTICO



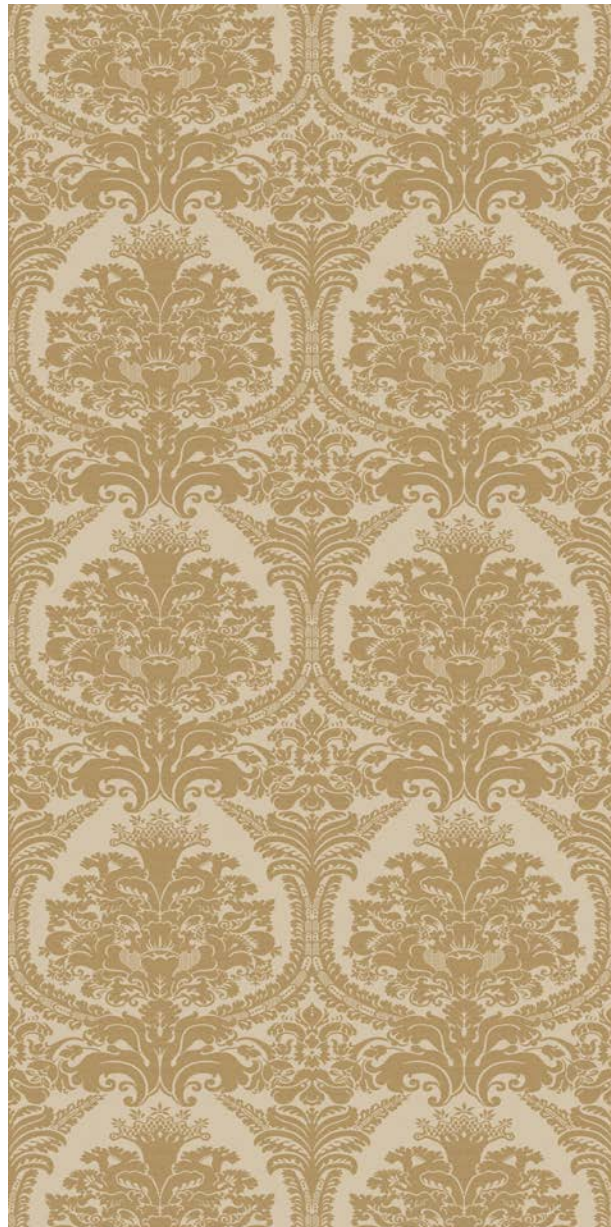

SAN MARCO AMBRA



6 mm 1/4" ↑↓
FLORIM OVERSIZE
magnUm

GRES PORCELLANATO DECORATO

DECORATED PORCELAIN TILES/GRÈS CÉRAME DÉCORÉ/VERZIERTES FEINSTEINZEUG/GRES PORCELÁNICO DECORADO/ДЕКОРИРОВАННЫЙ КЕРАМОГРАНИТ
SQUADRATO - SQUARED - EQUARRI - REKTIFIZIERT - ESCUADRADO - КАЛИБРОВАННАЯ

		6 mm 1/4" ↑↓		COLOR	SURFACE	120x280 47 ^{1/4"} x110 ^{1/4"}	120x240 47 ^{1/4"} x94 ^{1/2"}	60x120 A 23 ^{5/8"} x47 ^{1/4"}	60x120 B 23 ^{5/8"} x47 ^{1/4"}	60x120 C 23 ^{5/8"} x47 ^{1/4"}	60x120 D 23 ^{5/8"} x47 ^{1/4"}	60x120 23 ^{5/8"} x47 ^{1/4"} A+B+C+D
I FILATI DI REX		SAN MARCO AVORIO ANTICO	MATTE	767060 ■ FL-42900	767095 ■ FL-42900	767132 ■ FL-39700	769094 ■ FL-39700	769095 ■ FL-39700	769096 ■ FL-39700	9000221 ■ FL-39700		
		SAN MARCO AMBRA	MATTE	767061 ■ FL-42900	767096 ■ FL-42900	767133 ■ FL-39700	769139 ■ FL-39700	769140 ■ FL-39700	769141 ■ FL-39700	9000223 ■ FL-39700		

RUBELLI
design

SAN MARCO GRANATA

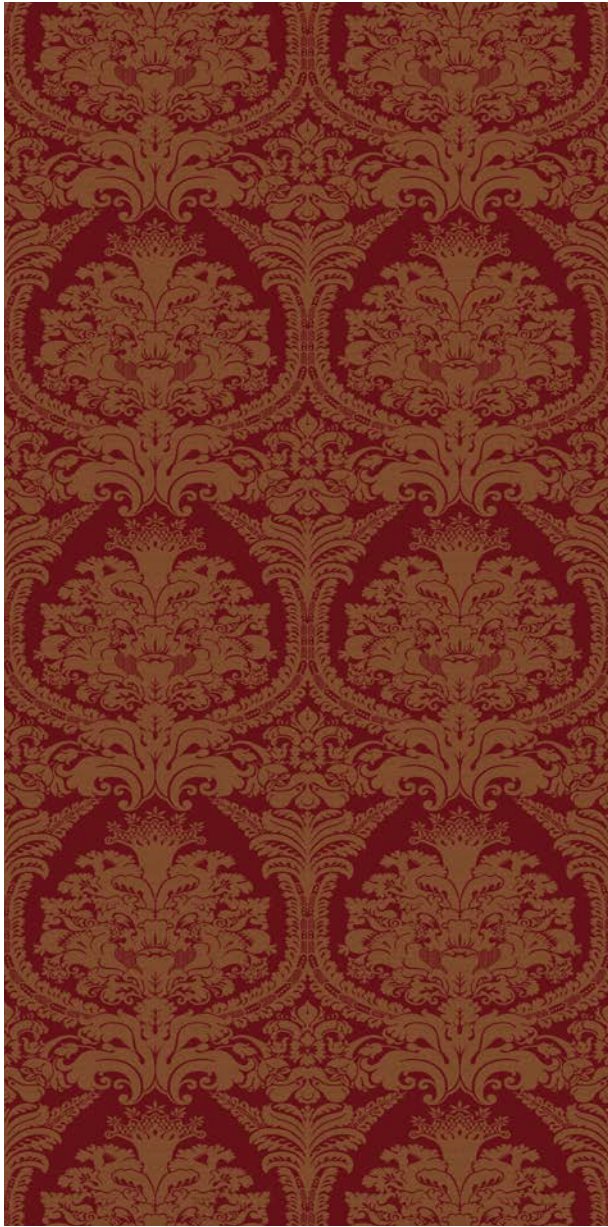

SAN MARCO BLU DI PRUSSIA



6 mm 1/4" ↑
FLORM OVERSIZE
magnUm

GRES PORCELLANATO DECORATO

DECORATED PORCELAIN TILES/GRÉS CÉRAMÉ DÉCORÉ/VERZIERTES FEINSTEINZEUG/GRES PORCELÁNICO DECORADO/ДЕКОРИРОВАННЫЙ КЕРАМОГРАНИТ
SQUADRATO - SQUARED - EQUARRI - REKTIFIZIERT - ESCUADRADO - КАЛИБРОВАННАЯ

6 mm 1/4" ↑		COLOR	SURFACE	120x280 47 ^{1/4"} x110 ^{1/4"}	120x240 47 ^{1/4"} x94 ^{1/2"}	60x120 A 23 ^{5/8"} x47 ^{1/4"}	60x120 B 23 ^{5/8"} x47 ^{1/4"}	60x120 C 23 ^{5/8"} x47 ^{1/4"}	60x120 D 23 ^{5/8"} x47 ^{1/4"}	60x120 23 ^{5/8"} x47 ^{1/4"} A+B+C+D
I FILATI DI REX		SAN MARCO GRANATA	MATTE	767062 ■ FL-42900	767097 ■ FL-42900	767134 ■ FL-39700	769182 ■ FL-39700	769183 ■ FL-39700	769184 ■ FL-39700	9000224 ■ FL-39700
		SAN MARCO BLU DI PRUSSIA	MATTE	767063 ■ FL-42900	767098 ■ FL-42900	767135 ■ FL-39700	769200 ■ FL-39700	769201 ■ FL-39700	769202 ■ FL-39700	9000222 ■ FL-39700

RUBELLI
design

I FILATI DI REX

VAGUE VANIGLIA



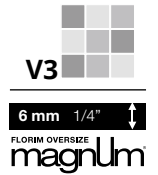

VAGUE CIPRIA



GRES PORCELLANATO DECORATO

DECORATED PORCELAIN TILES / GRÈS CÉRAMÉ DÉCORÉ / VERZIERTES FEINSTEINZEUG / GRES PORCELÁNICO DECORADO / ДЕКОРИРОВАННЫЙ КЕРАМОГРАНИТ

SQUADRATO - SQUARED - EQUARRI - REKTIFIZIERT - ESCUADRADO - КАЛИБРОВАННАЯ

		6 mm 1/4" ↓								
		COLOR	SURFACE	120x280 47 ^{1/4"} x110 ^{1/4"}	120x240 47 ^{1/4"} x94 ^{1/2"}	60x120 A 23 ^{5/8"} x47 ^{1/4"}	60x120 B 23 ^{5/8"} x47 ^{1/4"}	60x120 C 23 ^{5/8"} x47 ^{1/4"}	60x120 D 23 ^{5/8"} x47 ^{1/4"}	60x120 23 ^{5/8"} x47 ^{1/4"} A+B+C+D
I FILATI DI REX		VAGUE VANIGLIA	MATTE	767071 ■ FL-42900	767106 ■ FL-42900	767143 ■ FL-39700	769130 ■ FL-39700	769131 ■ FL-39700	769132 ■ FL-39700	9000228 ■ FL-39700
		VAGUE CIPRIA	MATTE	767072 ■ FL-42900	767107 ■ FL-42900	767144 ■ FL-39700	769115 ■ FL-39700	769116 ■ FL-39700	769117 ■ FL-39700	9000230 ■ FL-39700

RUBELLI
design

VAGUE GIADA

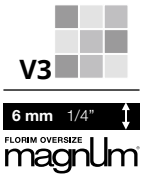
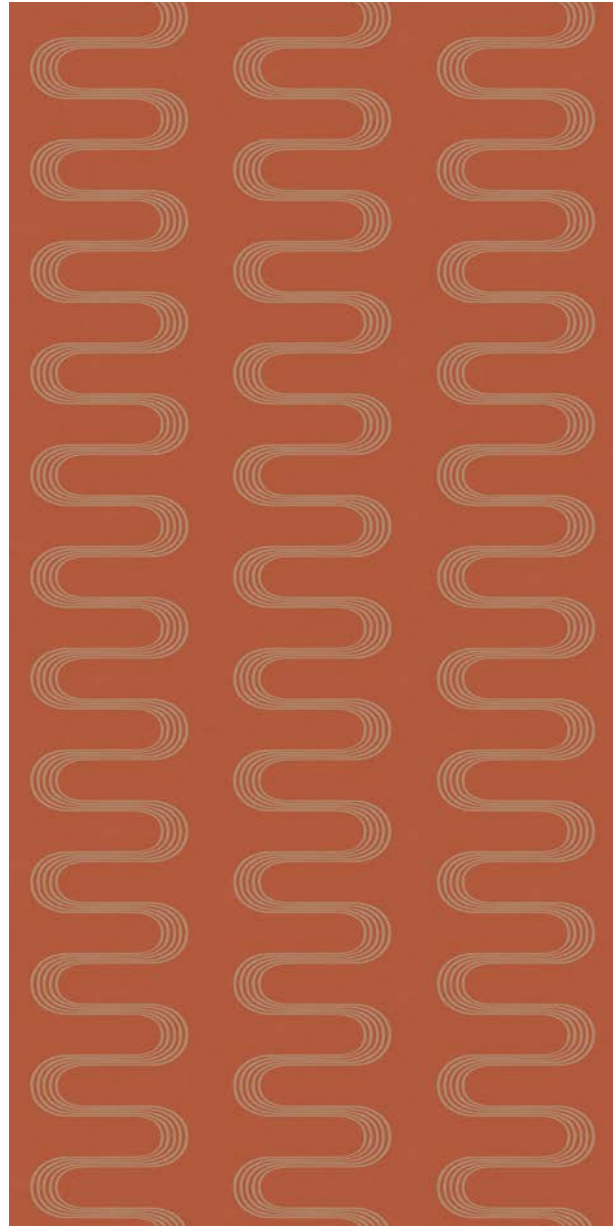
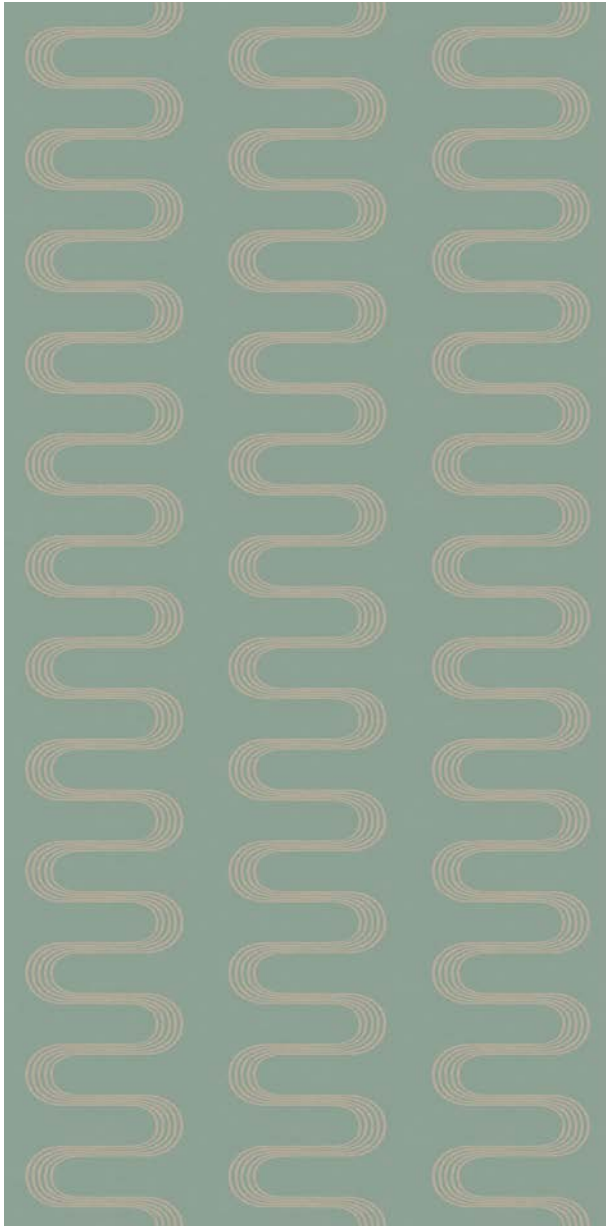

VAGUE SCARLATTO



GRES PORCELLANATO DECORATO

DECORATED PORCELAIN TILES/GRÈS CÉRAMÉ DÉCORÉ/VERZIERTES FEINSTEINZEUG/GRES PORCELÁNICO DECORADO/ДЕКОРИРОВАННЫЙ КЕРАМОГРАНИТ
SQUADRATO - SQUARED - EQUARRI - REKTIFIZIERT - ESCUADRADO - КАЛИБРОВАННАЯ

6 mm 1/4" ↑↓

	COLOR	SURFACE	120x280 47 ^{1/4"} x110 ^{1/4"}	120x240 47 ^{1/4"} x94 ^{1/2"}	60x120 A 23 ^{5/8"} x47 ^{1/4"}	60x120 B 23 ^{5/8"} x47 ^{1/4"}	60x120 C 23 ^{5/8"} x47 ^{1/4"}	60x120 D 23 ^{5/8"} x47 ^{1/4"}	60x120 23 ^{5/8"} x47 ^{1/4"} A+B+C+D
I FILATI DI REX	 VAGUE GIADA	MATTE	767073 ■ FL-42900	767108 ■ FL-42900	767145 ■ FL-39700	769145 ■ FL-39700	769146 ■ FL-39700	769147 ■ FL-39700	9000229 ■ FL-39700
	 VAGUE SCARLATTO	MATTE	767074 ■ FL-42900	767109 ■ FL-42900	767146 ■ FL-39700	769166 ■ FL-39700	769167 ■ FL-39700	769168 ■ FL-39700	9000231 ■ FL-39700

I FILATI DI REX

HAPPY HOUR VANIGLIA

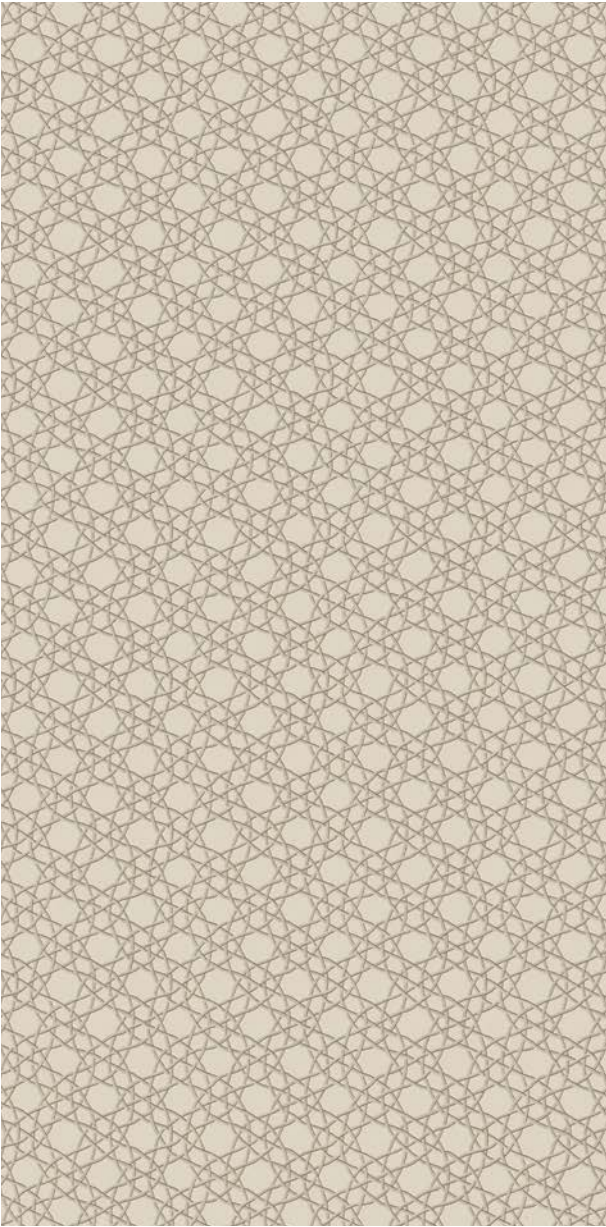

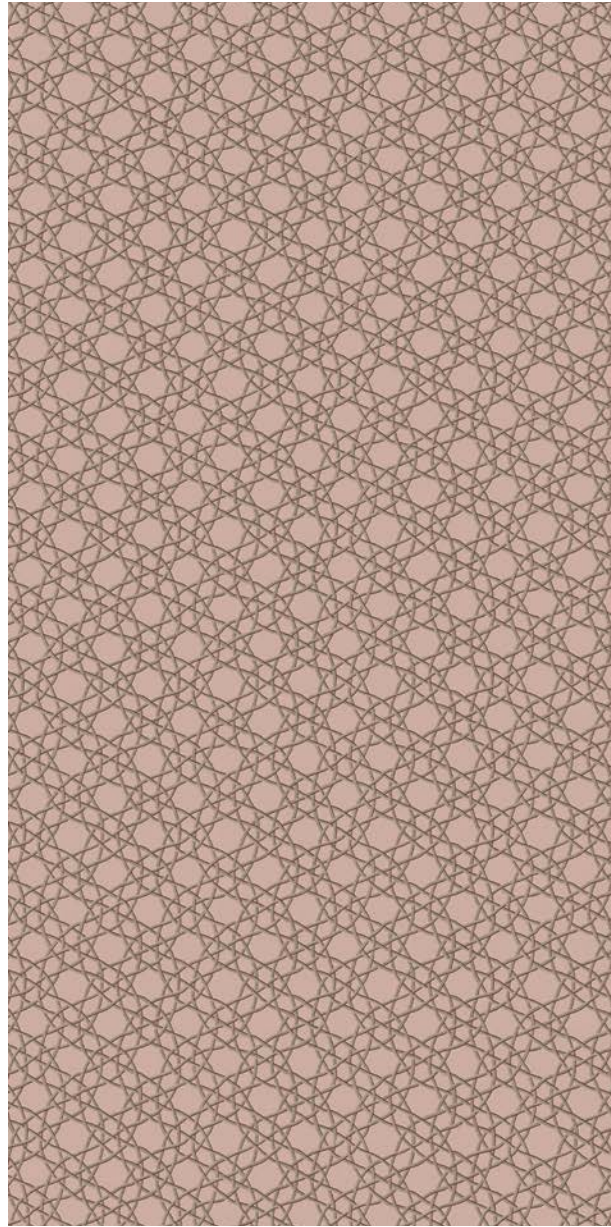

HAPPY HOUR CIPRIA



6 mm 1/4" ↑↓
FLORIM OVERSIZE
magnUm

GRES PORCELLANATO DECORATO

DECORATED PORCELAIN TILES/GRÈS CÉRAMÉ DÉCORÉ/VERZIERTES FEINSTEINZEUG/GRES PORCELÁNICO DECORADO/ДЕКОРИРОВАННЫЙ КЕРАМОГРАНИТ
SQUADRATO - SQUARED - EQUARRI - REKTIFIZIERT - ESCUADRADO - КАЛИБРОВАННАЯ

6 mm 1/4" ↑↓		COLOR	SURFACE	120x280 47 ^{11/16"} x110 ^{1/4"}	120x240 47 ^{1/4"} x94 ^{1/2"}	60x120 A 23 ^{5/8"} x47 ^{1/4"}	60x120 B 23 ^{5/8"} x47 ^{1/4"}	60x120 C 23 ^{5/8"} x47 ^{1/4"}	60x120 D 23 ^{5/8"} x47 ^{1/4"}	60x120 23 ^{5/8"} x47 ^{1/4"} A+B+C+D
I FILATI DI REX		HAPPY HOUR VANIGLIA	MATTE	767213 ■ FL-42900	767217 ■ FL-42900	767221 ■ FL-39700	769121 ■ FL-39700	769122 ■ FL-39700	769123 ■ FL-39700	9000232 ■ FL-39700
		HAPPY HOUR CIPRIA	MATTE	767214 ■ FL-42900	767218 ■ FL-42900	767222 ■ FL-39700	769106 ■ FL-39700	769107 ■ FL-39700	769108 ■ FL-39700	9000234 ■ FL-39700

RUBELLI
design

HAPPY HOUR GIADA



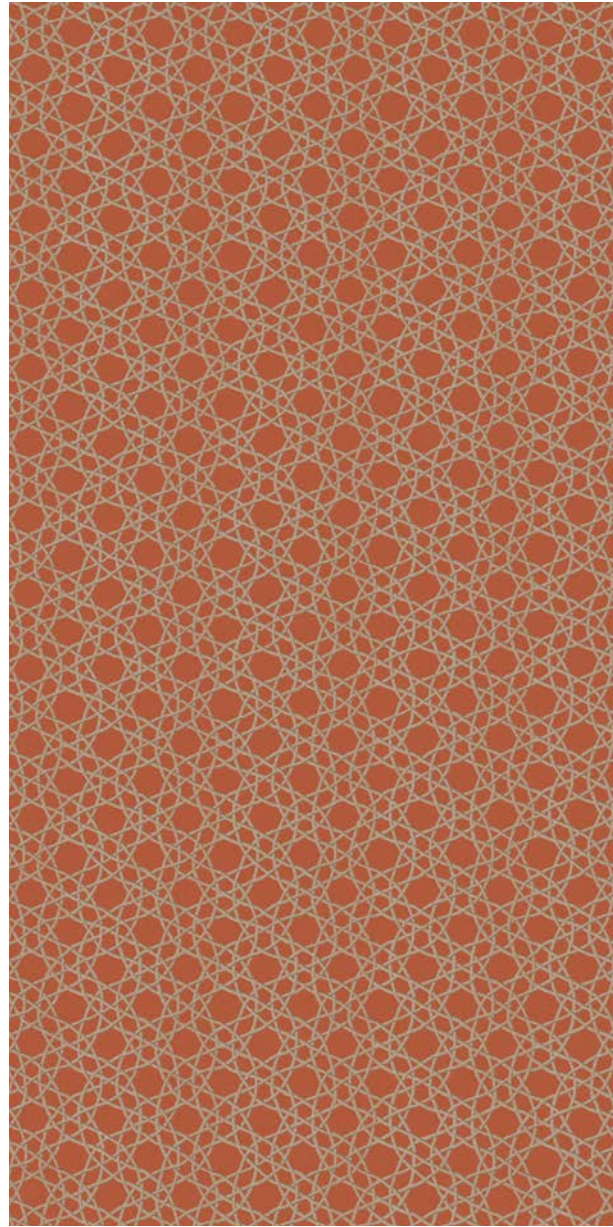

HAPPY HOUR SCARLATTO



GRES PORCELLANATO DECORATO

DECORATED PORCELAIN TILES/GRÉS CÉRAMÉ DÉCORÉ/VERZIERTES FEINSTEINZEUG/GRES PORCELÁNICO DECORADO/ДЕКОРИРОВАННЫЙ КЕРАМОГРАНИТ
SQUADRATO - SQUARED - EQUARRI - REKTIFIZIERT - ESCUADRADO - КАЛИБРОВАННАЯ

		6 mm 1/4" ↑↓		COLOR	SURFACE	120x280 47 ^{1/4"} x110 ^{1/4"}	120x240 47 ^{1/4"} x94 ^{1/2"}	60x120 A 23 ^{5/8"} x47 ^{1/4"}	60x120 B 23 ^{5/8"} x47 ^{1/4"}	60x120 C 23 ^{5/8"} x47 ^{1/4"}	60x120 D 23 ^{5/8"} x47 ^{1/4"}	60x120 23 ^{5/8"} x47 ^{1/4"} A+B+C+D
I FILATI DI REX		HAPPY HOUR GIADA	MATTE	767215 ■ FL-42900	767219 ■ FL-42900	767223 ■ FL-39700	769142 ■ FL-39700	769143 ■ FL-39700	769144 ■ FL-39700	9000233 ■ FL-39700		
		HAPPY HOUR SCARLATTO	MATTE	767216 ■ FL-42900	767220 ■ FL-42900	767224 ■ FL-39700	769163 ■ FL-39700	769164 ■ FL-39700	769165 ■ FL-39700	9000235 ■ FL-39700		

I FILATI DI REX

OP ART VANIGLIA

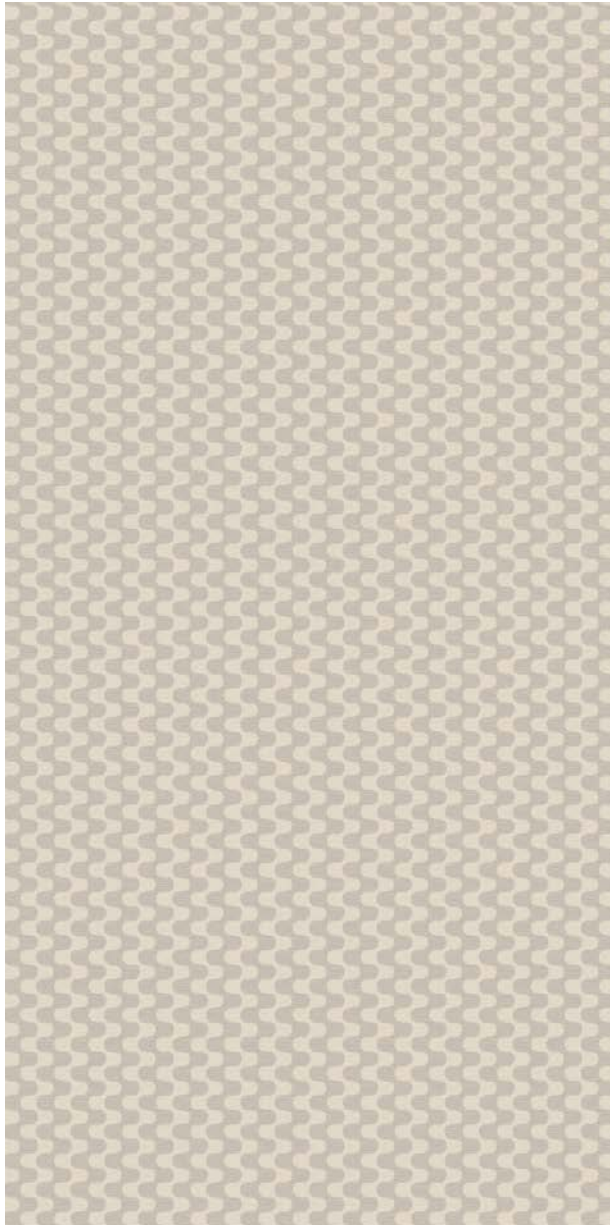

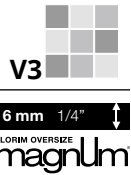
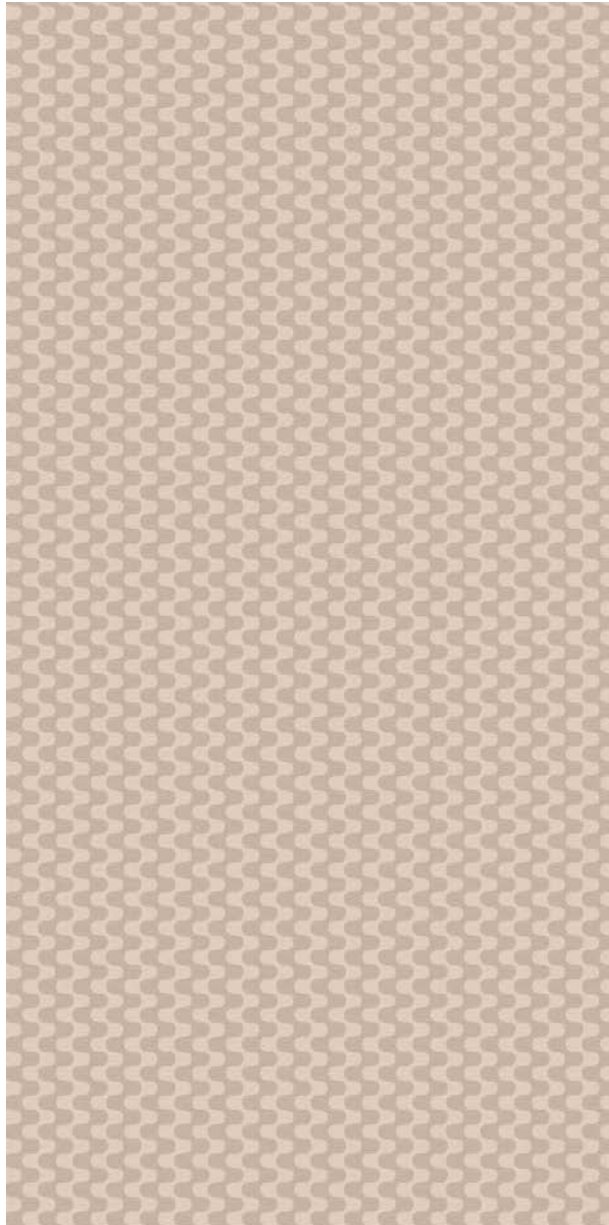

OP ART CIPRIA



GRES PORCELLANATO DECORATO

DECORATED PORCELAIN TILES/GRES CÉRAMÉ DÉCORÉ/VERZIERTES FEINSTEINZEUG/GRES PORCELÁNICO DECORADO/ДЕКОРИРОВАННЫЙ КЕРАМОГРАНИТ
SQUADRATO - SQUARED - EQUARRI - REKTIFIZIERT - ESCUADRADO - КАЛИБРОВАННАЯ

		6 mm 1/4" ↑↓		COLOR	SURFACE	120x280 47 ^{1/4"} x110 ^{1/4"}	120x240 47 ^{1/4"} x94 ^{1/2"}	60x120 A 23 ^{5/8"} x47 ^{1/4"}	60x120 B 23 ^{5/8"} x47 ^{1/4"}	60x120 C 23 ^{5/8"} x47 ^{1/4"}	60x120 D 23 ^{5/8"} x47 ^{1/4"}	60x120 23 ^{5/8"} x47 ^{1/4"} A+B+C+D
I FILATI DI REX		OP ART VANIGLIA	MATTE	767068 ■ FL-42900	767103 ■ FL-42900	767140 ■ FL-39700	769127 ■ FL-39700	769128 ■ FL-39700	769129 ■ FL-39700	9000225 ■ FL-39700		
		OP ART CIPRIA	MATTE	767069 ■ FL-42900	767104 ■ FL-42900	767141 ■ FL-39700	769112 ■ FL-39700	769113 ■ FL-39700	769114 ■ FL-39700	9000226 ■ FL-39700		

RUBELLI
design

Lastre decorate destinate esclusivamente al rivestimento di pareti interne. / Decorated panels designed exclusively for tiling interior walls. / Dalles décorées, exclusivement destinées au revêtement de parois intérieures. / Verzierte Platten, ausschließlich zur Verkleidung von Innenwänden bestimmt. / Losas decoradas destinadas exclusivamente al revestimiento de paredes interiores. / Декорированная плитка больших размеров, предназначенная исключительно для внутренней облицовки стен.

Gres porcellanato decorato: florim indica di stoccare il materiale in magazzini coperti o al riparo da agenti atmosferici / Florim recommends to stock the goods in covered warehouses, do not expose to the elements. Florim conseille de stocker le matériel dans des entrepôts couverts ou à l'abri des agents atmosphériques / Florim empfiehlt, das Material in geschlossenen Lagern oder in vor Witterungseinflüssen geschützten Bereichen zu lagern. / Florim indica almacenar el material en locales cubiertos o protegido de los agentes atmosféricos / ФЛОРИМ РЕКОМЕНДУЕТ ХРАНИТЬ ДАННЫЙ МАТЕРИАЛ В ЗАКРЫТЫХ СКЛАДСКИХ ПОМЕЩЕНИЯХ ИЛИ В ПОМЕЩЕНИЯХ, ЗАЩИЩЕННЫХ ОТ АТМОСФЕРНЫХ ОСАДКОВ

OP ART TÈ VERDE

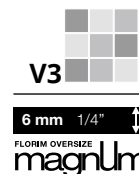
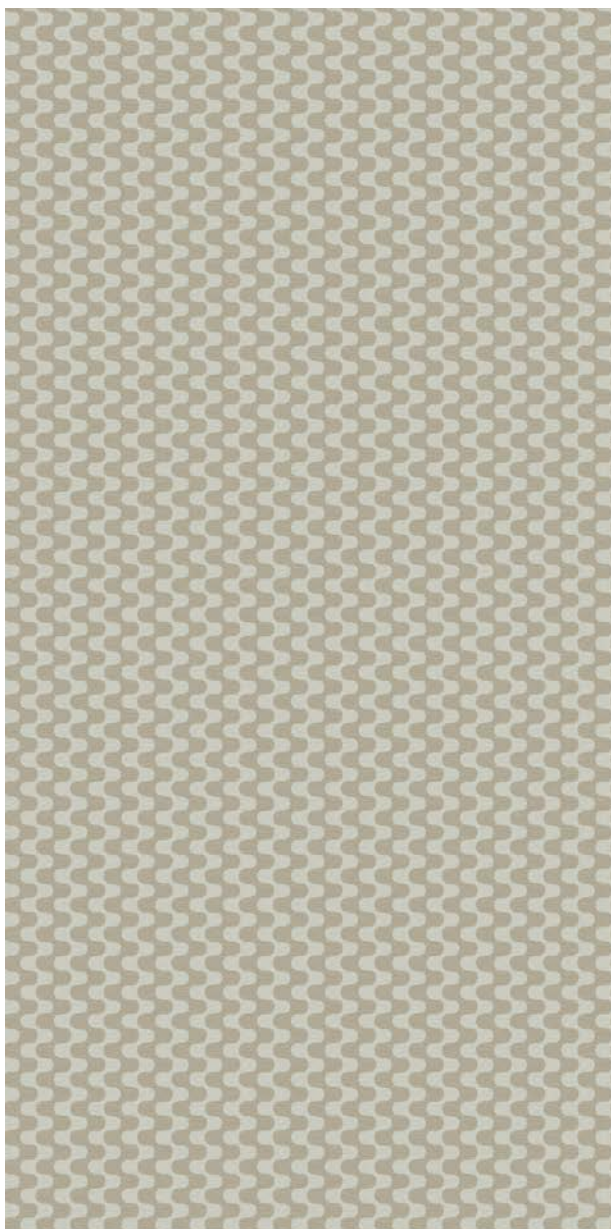

GRES PORCELLANATO DECORATO

DECORATED PORCELAIN TILES/GRÈS CÉRAMÉ DÉCORÉ/VERZIERTES FEINSTEINZEUG/GRES PORCELÁNICO DECORADO/ДЕКОРИРОВАННЫЙ КЕРАМОГРАНИТ

SQUADRATO - SQUARED - EQUARRI - REKTIFIZIERT - ESCUADRADO - КАЛИБРОВАННАЯ

6 mm 1/4" ↑↓	COLOR	SURFACE	120x280 47 ^{1/4"} x110 ^{1/4"}	120x240 47 ^{1/4"} x94 ^{1/2"}	60x120 A 23 ^{5/8"} x47 ^{1/4"}	60x120 B 23 ^{5/8"} x47 ^{1/4"}	60x120 C 23 ^{5/8"} x47 ^{1/4"}	60x120 D 23 ^{5/8"} x47 ^{1/4"}	60x120 23 ^{5/8"} x47 ^{1/4"} A+B+C+D
I FILATI DI REX	OP ART TÈ VERDE	MATTE	767070 ■ FL-42900	767105 ■ FL-42900	767142 ■ FL-39700	769148 ■ FL-39700	769149 ■ FL-39700	769150 ■ FL-39700	9000227 ■ FL-39700

RUBELLI
design

FLOHM OVERSIZE
magnUm

120x280/120x240

Specifica Imballo pag.
Packaging specifications on page
Spécifications d'emballage à page
Verpackungsdetail Seite
Especificaciones de embalaje a la página
Информация об упаковке на стр.
200/201

I FILATI DI REX	scatola - box			pallet		
	pz	mq	kg	box	mq	kg
60x120	2	1,44	20,90	20	28,80	440

I FILATI DI REX

Lady Hamilton cipria A+B+C+D

60x120 (23^{5/8}"x 47^{1/4}")

cod 9000204

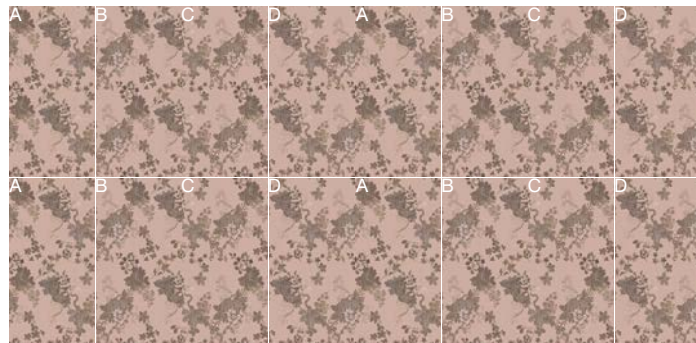

A
60x120
cod.767113

B
60x120
cod.769109

C
60x120
cod.769110

D
60x120
cod.769111

posa verticale
vertical installation

Lady Hamilton amaranto A+B+C+D

60x120 (23^{5/8}"x 47^{1/4}")

cod 9000205



A
60x120
cod.767115

B
60x120
cod.769160

C
60x120
cod.769161

D
60x120
cod.769162

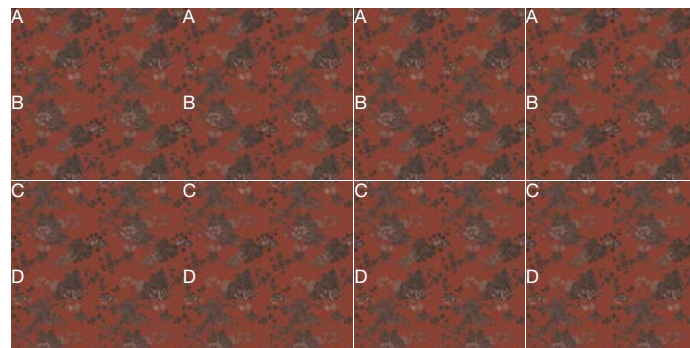

posa orizzontale
horizontal installation

Ordinando il codice es 9000204 il cliente riceverà 4 scatole, ogni scatola contiene 2 pz delle grafiche A / B / C / D. - By ordering code (for example 9000204) the customer will receive 4 boxes, each box contains 2 pcs of the designs A/B/C/D. - En commandant le code (par exemple 9000204) le client recevra 4 boites, chaque boite contiendra 2 pcs des motifs A / B / C / D. - Bei Bestellung des Codes (z.B. 9000204) erhält der Kunde 4 Kartons, jeder Karton enthält 2 Stück der Grafiken A / B / C / D. - Al pedir el código (por ejemplo, 9000204), el cliente recibirá 4 cajas, cada caja contendrá 2 piezas de cada uno de los gráficos A / B / C / D. **Заказывая позицию (например, 9000204), клиент получит 4 коробки, каждая коробка будет содержать 2 штуки из график A / B / C / D.**

Ordinando il codice es 767113 il cliente riceverà una scatola contenente 2 pezzi della grafica A. - By ordering code (for example 767113) the customers will receive 2 pcs of the design A. - En commandant le code (par exemple 767113) le client recevra 1 boite, qui contiendra 2 pièces du motif A. - Mit der Bestellung des Codes (z.B. 767113) erhält der Kunde eine Schachtel mit 2 Grafiken A. - Al pedir el código (por ejemplo, 767113), el cliente recibirá una caja que contendrá 2 piezas del gráfico A. **Заказывая позицию (например, 767113), клиент получит коробку, содержащую 2 штуки графики A.**

I FILATI DI REX nel formato 60x120 identificati dai codici 9000 ABCD compongono il disegno nel formato 120x240, nel caso di danneggiamento di uno dei 4 pezzi si possono ordinare separatamente facendo riferimento al numero seriale seguito dalla lettera./ I FILATI DI REX size 60x120 identified by item codes 9000 ABCD compose the design in size 120x240; should one of the elements be damaged, they can be ordered separately making reference to the serial number followed by the letter./ I FILATI DI REX identifiés pour le format 60x120 avec les codes 9000 ABCD composent ensemble le dessin dans le format 120x240; en cas d'endommagement d'une des 4 plaques, elle peuvent être commandées séparément en se référant au numéro de série suivi de la lettre./ Filati di Rex im 60x120-Format, die durch die 9000 ABCD-Codes gekennzeichnet sind, bilden das Bild im 120x240-Format. Wenn eines der 4 Teile beschädigt ist, kann es unter Bezugnahme auf die Seriennummer gefolgt vom Buchstaben separat bestellt werden./ I FILATI DI REX en el formato 60x120 identificado por los códigos 9000 ABCD conforman el diseño en el formato 120x240; Si una de las 4 piezas está dañada, se puede pedir por separado haciendo referencia al número de serie seguido de la letra./ I FILATI DI REX в формате 60x120, идентифицируемом кодами 9000 ABCD, в совокупности составляет формат 120x240; если одна из 4 частей повреждается, ее можно заказать отдельно, указывая серийный код, за которым следует буква.

Ogni soggetto è caratterizzato da una decorazione che continua da pezzo a pezzo considerando 1mm di fuga. Prima di passare alla fase di posa stendere i vari soggetti a terra per verificarne la continuità del prodotto. / Each panel features a pattern that continues from piece to piece with a 1 mm joint. Before laying, spread the various panels on the ground to check the pattern's continuity. / Chaque sujet se caractérise par une décoration qui continue d'une pièce à l'autre, en tenant compte de 1 mm de joint. Avant de passer à la phase de pose, étaler les différents sujets au sol, pour en vérifier la continuité de la décoration. / Jedes Muster ist von einem Dekor charakterisiert, das von Platte zu Platte weiterverläuft, wenn man von der 1 mm Fuge absieht. Sollte vor dem Verlegen die einzelnen Muster auf den Boden angeordnet werden, um die Kontinuität des Dekors zu prüfen. / Cada pieza se caracteriza por una decoración que continúa de una a otra con una fuga de 1 mm. Antes de pasar a la fase de colocación extender los diferentes motivos sobre el suelo para comprobar la continuidad de la decoración. / Каждая коллекция характеризуется декоративным узором, который продолжается от плитки к плитке, с учетом межплиточного шва шириной 1 мм. перед переходом к фазе укладки необходимо разложить плитку с различными узорами на полу, чтобы проверить непрерывность полученного рисунка.

GRES PORCELLANATO DECORATO / DÉCORÉ PORCELAIN TILES / GRÉS CÉRAMÉ DÉCORÉ / VERZIERTES FEINSTEINZEUG / GRES PORCELÁNICO DECORADO / ДЕКОРИРОВАННЫЙ КЕРАМОГРАНИТ

AVVERTENZE / WARNINGS / AVERTISSEMENTS / ADVERTENCIAS / HINWEISE / ПРЕДУПРЕЖДЕНИЕ / 警告

Destinazione D'uso / Recommended Applications / Domaine D'Application / Anwendungsbereiche / USO PREVISTO / Назначение / 用途
Lastre decorate con innovative tecniche artigianali destinate esclusivamente al rivestimento di pareti interne...

Movimentazione / Handling / Manutention / Transport und Handvahnung / Desplazamiento / Перемещение / 搬运
Nella movimentazione evitare il contatto con materiali abrasivi e lo strofinamento con altre lastre o con il piano di lavoro...

Taglio/Foro / Cutting/Drilling / Découpe/Trou / Schneiden/Bohren / Corte/orificio / Резка/Отверстие / 切割/钻孔
Verificare che il piano di appoggio sia perfettamente stabile, planare, pulito e privo di ogni asperità che possa danneggiare il materiale...

Posa / Installation / Pose / Verlegen / Colocación / Укладка / 铺设
Si consiglia l'uso di distanziatori livellanti tradizionali. È possibile utilizzare i livellanti a vite dotati di guarnizione protettiva...

Indicazioni Generali / General Instructions / Indications Générales / Allgemeine Hinweise / Indications Générales / Общие Указания / 一般性说明
Florim indica di stoccare il materiale in magazzini coperti o al riparo da agenti atmosferici, coprendo il materiale con cappucci protettivi...

Stuccatura / Grouting / Réalisation Des Joints / Verlegen / Rejuntado / Затирка
Si consiglia l'uso di sigillanti cementizi a grana fine e spatole in materiale plastico. Si consiglia l'uso di silicone acetico come sigillante...

Pulizia Post Posa / Post-Installation Cleaning / Nettoyage Après Pose / Erstreinigung / Limpieza Tras La Colocación / Чистка После Укладки / 铺设后的清洁
Avere cura di pulire i residui prima dell'indurimento dello stucco con acqua e spugna non abrasiva evitando di danneggiare la superficie della lastra...

Pulizia Quotidiana / Daily Maintenance / Entretien Quotidien / Unterhaltsreinigung / Limpieza Cotidiana / Ежедневная Очистка / 日常清洁
Utilizzare detergenti neutri e/o acqua, pulendo con straccio in microfibra o spugna morbida. Prodotti acidi anticalcare possono essere utilizzati...



I MARMI DI REX

gres porcellanato colorato in massa
coloured body porcelain stoneware
grès cérame colore dans la masse
durchgefärbte feinsteinzeug
gres porcelánico coloreado en masa
керамогранит, окращенный по всей толщине





I MARMI DI REX

Eleganza esatta e perfetta, **I marmi di rex** interpretano l'eredità di un passato rimasto inalterato. Riscoprono la bellezza intrinseca di una materia senza pretenziosità. Donano allo spazio un'atmosfera originale, in grado di creare scenografie precise e personali.

Precise and perfect elegance, the **I marmi di rex** line interprets the inheritance of an unaltered past. It rediscovers the intrinsic beauty of a material without pomposity. It gives space an original atmosphere, able to create precise and personal settings.

Élégance exacte et parfaite, **I marmi di rex** interprètent l'héritité d'un passé resté inaltéré. Ils redécouvrent la beauté typique d'un matériau sans prétention. Ils créent une ambiance originale en mesure de faire naître des scénographies précises et personnelles.

Exakte und perfekte Eleganz, die Kollektion **I marmi di rex** interpretiert das Erbe einer Vergangenheit, die unverändert geblieben ist. Sie entdecken die wesenseigene Schönheit der Materie ohne Anmaßung wieder. Sie schenken dem Raum eine originelle Atmosphäre, die präzise und persönliche Szenen schaffen kann.

Elegancia exacta y perfecta, la línea **I marmi di rex** interpreta la herencia de un pasado que permanece inalterado. Descubre la belleza intrínseca de una materia que no tiene presunciones. Da al área una atmósfera original, capaz de crear escenografías precisas y personales.

Точная и совершенная элегантность **I marmi di rex** (мрамор) показывают оставшееся без изменений наследие прошлого. Эти типы мрамора заново раскрывают внутреннюю красоту непретенциозного материала. Они украшают помещение и могут создать точную и индивидуальную обстановку.

I MARMI DI REX

MARBLE GRAY



V2

R9
(matte)

DCOF >
0,42 Wet
(matte)

10 mm 3/8" ↑↓

GRES PORCELLANATO COLORATO IN MASSA/COLOURED BODY PORCELAIN STONEWARE
GRÈS CÉRAMÉ COLORE DANS LA MASSE/DURCHGEFÄRBTE FEINSTEINZEUG/GRES PORCELÁNICO COLOREADO EN MASA/керамогранит, окрашенный по всей тлщине
SQUADRATO - SQUARED - EQUARRI - REKTIFIZIERT - ESCUADRADO - КАЛИБРОВАННАЯ

		COLOR	SURFACE	80x180 31 ^{1/2} "x70 ^{6/7} "	80x80 31 ^{1/2} "x31 ^{1/2} "	60x120 23 ^{5/8} "x47 ^{1/4} "	60x60 23 ^{5/8} "x23 ^{5/8} "
I MARMI DI REX		MARBLE GRAY	MATTE	736347 ■ FL-11300	735821 ■ FL-08400	728975 ■ FL-09300	728957 ■ FL-08100
			SHINY	736239 ■ FL-13400	735825 ■ FL-09700	728976 ■ FL-10800	728958 ■ FL-09700

10 mm 3/8" ↑↓	COLOR	SURFACE	30x30 11 4/5" x 11 4/5"	30x30 11 4/5" x 11 4/5"
			mosaico tessere 3x15 pz/box 11	mosaico 3D Mix tessere 3x3 pz/box 9
I MARMI DI REX	MARBLE GRAY	MATTE	729061 ▲ FL-14500	729068 ▲ FL-04400
		SHINY	729062 ▲ FL-16100	

PEZZI SPECIALI/SPECIAL TRIMS/PIÈCES SPÉCIALES/FORMSTÜCKE/PIEZAS ESPECIALES/Специальные изделия

10 mm 3/8" ↑↓	COLOR	SURFACE	4,6x60 1 4/5" x 23 5/8"	1x15 2/5" x 6"	1x16 2/5" x 6 2/7"
			battiscopa	quarter round pz/box 12	angolo quarter round pz/box 4
I MARMI DI REX	MARBLE GRAY	MATTE	745448 ◆ FL-01600	729021 ▲ FL-00760	729029 ▲ FL-00760
		SHINY	745444 ◆ FL-01600	729022 ▲ FL-00760	729030 ▲ FL-00760

Per un effetto ottimale della posa, florim suggerisce di mantenere 2 mm di fuga per pose monofornate e 3 mm per combinare formati misti - For optimal installation results, florim recommends maintaining a joint of 2 mm 1/12" for single format installations and 3 mm 1/8" to combine mixed formats. - Pour réaliser une pose parfaite, florim suggère de maintenir 2 mm de joint pour la pose des monofornats, et 3 mm pour les combinaisons de formats mixtes. - Um einen optimalen effekt beim verlegen zu erzielen empfiehlt florim eine 2 mm fugen bei einformatigen verlegungen und 3 mm fugen bei formatkombinationen Para lograr los maximos resultados en la posa del producto, florim aconseja 2 mm de junta en aplicaciones monofornate y 3 mm en combinaciones de formatos mixtos - **ДЛЯ ОПТИМАЛЬНОЙ УКЛАДКИ " FLORIM" РЕКОМЕНДУЕТ ВЫДЕРЖИВАТЬ ЗАЗОР 2 ММ ДЛЯ МОНОФОРМАТА И 3 ММ ПРИ СМЕШАННЫХ ФОРМАТАХ.**

I MARMI DI REX	scatola - box			pallet		
	pz	mq	kg	box	mq	kg
80x180	2	2,88	67,25	20	57,60	1400
60x120	2	1,44	33,40	30	43,20	1030
80x80	2	1,28	29,80	40	51,20	1220
60x60	3	1,08	24,80	40	43,20	1020

I MARMI DI REX	scatola - box			pallet		
	pz	ml	kg	box	mq	kg
4,6x60 battiscopa	14	8,40	8,40	-	-	-

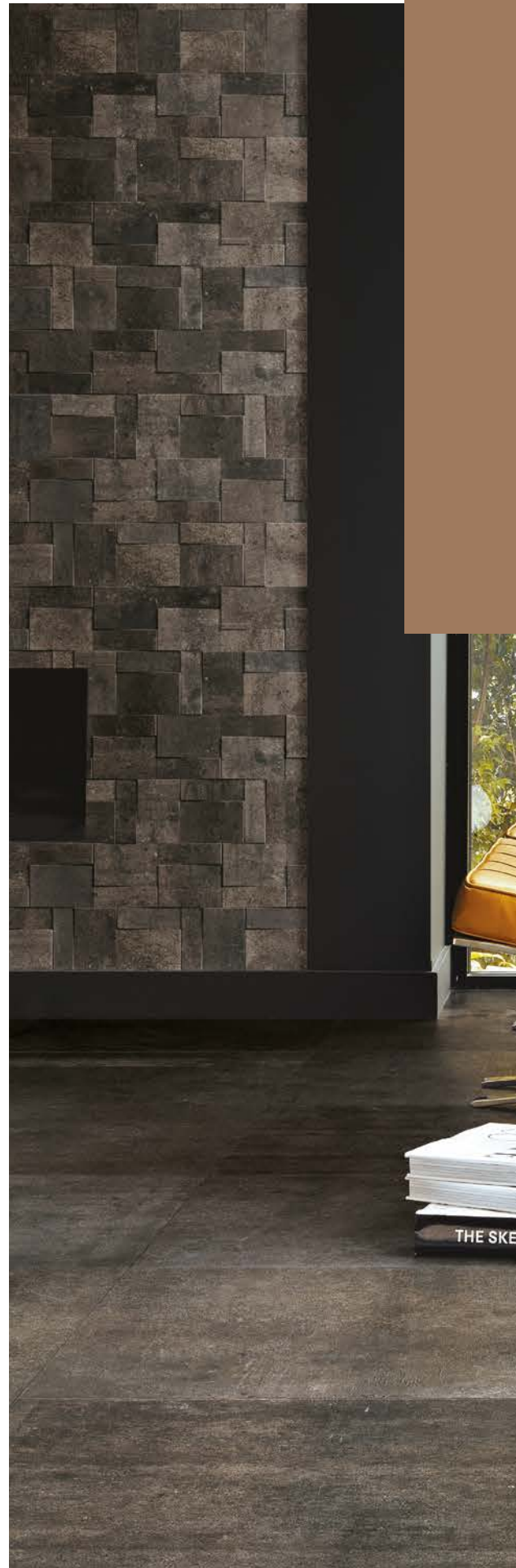

LA ROCHE DI REX

gres fine porcellanato
fine porcelain stoneware
grès cérame fin
feinsteinzeug-kollektionen
gres porcelánico fino
фарфоровый керамогранит





LA ROCHE DI REX

Dall'intesa fra natura e uomo prende forma **La roche di rex**, pietra densa di stratificazioni dal sapore francese. Rex esplora eleganti contrasti in cui il fascino romantico della pietra prorompe grazie ad accostamenti dal sapore contemporaneo.

The relationship between man and nature shapes **La roche**: a french-style sedimentary stone. Rex explores elegant contrasts where the romantic charm of the stone bursts through combinations rich in contemporary flavour.

La Roche voit le jour de l'entente entre la nature et l'homme, pierre dense en stratifications de style français. Rex explore d'élégants contrastes dont la fascination romantique de la pierre éclate grâce à des approches au style contemporain.

Aus dem Einklang zwischen Natur und Mensch entspringt **La Roche**: ein schichtenreicher Stein mit französischem Flair. Rex erkundet elegante Kontraste, in denen der romantische Zauber des Steins dank moderner Kombinationen voll zur Geltung kommt.

Del acuerdo entre el hombre y la naturaleza nace **La Roche**, piedra densa de estratificaciones con gusto francés. Rex explora contrastes elegantes con la fascinación romántica de la piedra que prorrumpe gracias a combinaciones de gusto contemporáneo.

Подлинно французский отделочный материал **La Roche** – плотный слоистый камень, отражающий гармонию между природой и мастерством человека. Rex демонстрирует элегантные контрасты, в которых благодаря актуальным стилистическим сочетаниям проявляется романтическое очарование камня.

LA ROCHE DI REX

LA ROCHE BLANC



LA ROCHE ECRU



V3

R9
(smooth)

R10
CLASSE A
(anticato naturale)

R11
CLASSE B
(strutturato)

DCOF>
0,42 Wet

10 mm 3/8"



V3

DCOF>
0,42 Wet





6 mm 1/4"

FLORIM OVERSIZE
magnum

GRES FINE PORCELLANATO

FINE PORCELAIN STONEWARE/GRES CERAME FIN/FEINSTEINZEUG-KOLLEKTIONEN/GRES PORCELANICO FINO/ФАРФОРОВЫЙ КЕРАМОГРАНИТ

SQUADRATO - SQUARED - EQUARRI - REKTIFIZIERT - ESCUADRADO - КАЛИБРОВАННАЯ

10 mm 3/8"		COLOR	SURFACE	80x80 31 ^{1/2"} x31 ^{1/2"}	40x80 15 ^{3/4"} x31 ^{1/2"}	60x120 23 ^{5/8"} x47 ^{1/4"}	60x60 23 ^{5/8"} x23 ^{5/8"}
LA ROCHE DI REX		LA ROCHE BLANC	ANTICATO NATURALE	742034 ■ FL-09300	742038 ■ FL-07000	741767 ■ FL-10300	742211 ■ FL-07000
		LA ROCHE BLANC	STRUTTURATO BORDO DRITTO	-	742714 ■ FL-07000	-	-
		LA ROCHE BLANC	SMOOTH BORDO DRITTO	742710 ■ FL-09300	-	-	-
		LA ROCHE ECRU	ANTICATO NATURALE	742035 ■ FL-09300	742039 ■ FL-07000	741784 ■ FL-10300	742212 ■ FL-07000
		LA ROCHE ECRU	STRUTTURATO BORDO DRITTO	-	742716 ■ FL-07000	-	-
		LA ROCHE ECRU	SMOOTH BORDO DRITTO	742712 ■ FL-09300	-	-	-
6 mm 1/4"		COLOR	SURFACE	120x280 47 ^{1/4"} x110 ^{1/4"}	120x240 47 ^{1/4"} x94 ^{1/2"}	120x120 47 ^{1/4"} x47 ^{1/4"}	60x120 23 ^{5/8"} x47 ^{1/4"}
LA ROCHE DI REX		LA ROCHE BLANC	SMOOTH	758829 ■ FL-12400	744488 ■ FL-11300	744493 ■ FL-09700	744498 ■ FL-09100
		LA ROCHE ECRU	SMOOTH	758831 ■ FL-12400	744490 ■ FL-11300	744495 ■ FL-09700	744500 ■ FL-09100

LA ROCHE GREY



LA ROCHE MUD



V3
R9
(smooth)

R10
CLASSE A
(anticato naturale)

R11
CLASSE B
(strutturato)

DCOF>
0,42 Wet

10 mm 3/8" ↑↓





V3
DCOF>
0,42 Wet

6 mm 1/4" ↑↓







FLORIM OVERSIZE
magnUlm

GRES FINE PORCELLANATO

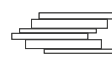





FINE PORCELAIN STONEWARE/GRES CERAME FIN/FEINSTEINZEUG-KOLLEKTIONEN/GRES PORCELANICO FINO/ФАРФОРОВЫЙ КЕРАМОГРАНИТ
SQUADRATO - SQUARED - EQUARRI - REKTIFIZIERT - ESCUADRADO - КАЛИБРОВАННАЯ

10 mm 3/8" ↑↓		COLOR	SURFACE	80x80 31 1/2" x 31 1/2"	40x80 15 3/4" x 31 1/2"	60x120 23 5/8" x 47 1/4"	60x60 23 5/8" x 23 5/8"
LA ROCHE DI REX		LA ROCHE GREY	ANTICATO NATURALE	742036 ■ FL-09300	742040 ■ FL-07000	741785 ■ FL-10300	742213 ■ FL-07000
			STRUTTURATO BORDO DRITTO	-	742715 ■ FL-07000	-	-
			SMOOTH BORDO DRITTO	742711 ■ FL-09300	-	-	-
		LA ROCHE MUD	ANTICATO NATURALE	742037 ■ FL-09300	742041 ■ FL-07000	741786 ■ FL-10300	742214 ■ FL-07000
			STRUTTURATO BORDO DRITTO	-	742717 ■ FL-07000	-	-
			SMOOTH BORDO DRITTO	742713 ■ FL-09300	-	-	-
6 mm 1/4" ↑↓		COLOR	SURFACE	120x280 47 1/4" x 110 1/4"	120x240 47 1/4" x 94 1/2"	120x120 47 1/4" x 47 1/4"	60x120 23 5/8" x 47 1/4"
LA ROCHE DI REX		LA ROCHE GREY	SMOOTH	758830 ■ FL-12400	744489 ■ FL-11300	744494 ■ FL-09700	744499 ■ FL-09100

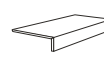
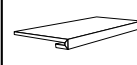
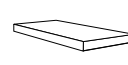
LA ROCHE DI REX

10 mm 3/8" ↓		COLOR	SURFACE	30x30 11 ^{4/5"} x11 ^{4/5"}  mosaico tessere 5x5	21x40 8 ^{1/4"} x15 ^{3/4"}  modulo listello sfalsato mix anticato naturale/strutturato	30x30 11 ^{4/5"} x11 ^{4/5"}  modulo muretto 3D pz/box 6
LA ROCHE DI REX		LA ROCHE BLANC	ANTICATO NATURALE	742228 ■ FL-15600	742236 ■ FL-21500	742240 ▲ FL-03600
		LA ROCHE ECRU	ANTICATO NATURALE	742229 ■ FL-15600	742237 ■ FL-21500	742241 ▲ FL-03600
		LA ROCHE GREY	ANTICATO NATURALE	742230 ■ FL-15600	742238 ■ FL-21500	742242 ▲ FL-03600
		LA ROCHE MUD	ANTICATO NATURALE	742231 ■ FL-15600	742239 ■ FL-21500	742243 ▲ FL-03600

PEZZI SPECIALI/SPECIAL TRIMS/PIÈCES SPÉCIALES/FORMSTÜCKE/PIEZAS ESPECIALES/Специальные изделия

10 mm 3/8" ↓		COLOR	SURFACE	4,6x60 1 ^{4/5"} x23 ^{5/8"}  battiscopa	15,2x30,4x4 6"x12" x1 ^{4/7"}  elemento Elle strutturato	33x120x3 13"x47 ^{1/4"} x1 ^{1/8"}  gradino pz/box 2	33x120x3 13"x47 ^{1/4"} x1 ^{1/8"}  angolo gradino DX pz/box 2	33x120x3 13"x47 ^{1/4"} x1 ^{1/8"}  angolo gradino SX pz/box 2
LA ROCHE DI REX		LA ROCHE BLANC	ANTICATO NATURALE	745449 ◆ FL-01600	742248 ▲ FL-02400	742252 ▲ FL-20400	742256 ▲ FL-31100	742260 ▲ FL-31100
		LA ROCHE ECRU	ANTICATO NATURALE	745450 ◆ FL-01600	742249 ▲ FL-02400	742253 ▲ FL-20400	742257 ▲ FL-31100	742261 ▲ FL-31100
		LA ROCHE GREY	ANTICATO NATURALE	745451 ◆ FL-01600	742250 ▲ FL-02400	742254 ▲ FL-20400	742258 ▲ FL-31100	742262 ▲ FL-31100
		LA ROCHE MUD	ANTICATO NATURALE	745452 ◆ FL-01600	742251 ▲ FL-02400	742255 ▲ FL-20400	742259 ▲ FL-31100	742263 ▲ FL-31100







Per anticato si intende materiale con bordo irregolare. / "Antique finish" means tiles with an uneven edge. / Le terme « vieilli » désigne un matériau au bord irrégulier. / Unter Antik versteht man ein Material mit unregelmäßigem Rand. / Por "envejecido" se entiende el material con borde irregular. / Под состаренным подразумевается материал с неровной кромкой.

In relazione alle differenti tecnologie produttive l'accostamento di prodotti con spessori diversi potrebbe presentare delle disomogeneità, se ne sconsiglia pertanto l'abbinamento. / Due to the different production technologies, contiguous installation of products with different thickness may give a non-homogeneous result. For this reason we do not recommend this option. / Vu que différentes technologies de production sont utilisées avec des épaisseurs différentes, des problèmes d'homogénéité pourraient se présenter, il est donc déconseillé de les poser ensemble. / Wegen unterschiedlicher Produktionstechnologien können die Fliesen mit verschiedenen Materialstärken optische Differenzen aufweisen. Von einem direkten Aneinanderlegen wird deshalb abgeraten. / Dadas las diferentes tecnologías productivas, la combinación de productos de diferentes espesores podría dar lugar a heterogeneidad, por lo que se desaconseja mezclarlas. / В связи с различием в технологиях производства, сочетание продукции разной толщины иногда может представлять неоднородность материала. Такие сочетания следует избегать.

Per un effetto ottimale della posa, florim suggerisce di mantenere 2 mm di fuga per pose monoformato e 3 mm per combinare formati misti. - For optimal installation results, florim recommends maintaining a joint of 2 mm - 1/16" for single format installations and 3 mm - 1/8" to combine mixed formats. - Pour réaliser une pose parfaite, florim suggère de maintenir 2 mm de joint pour la pose des monoformats, et 3 mm pour les combinaisons de formats mixtes. - Um einen optimalen effekt beim verlegen zu erzielen empfiehlt florim eine 2 mm fugе bei einformatigen verlegungen und 3 mm fugе bei formatkombinationen Para lograr los máximos resultados en la posa del producto, florim aconseja 2 mm de junta en aplicaciones monoformato y 3 mm en combinaciones de formatos mixtos. - ДЛЯ ОПТИМАЛЬНОЙ УКЛАДКИ - FLORIM® РЕКОМЕНДУЕТ ВЫДЕРЖИВАТЬ ЗАЗОР 2 ММ ДЛЯ МОНОФОРМАТА И 3 ММ ПРИ СМЕШАННЫХ ФОРМАТАХ.

LA ROCHE DI REX	scatola - box			pallet		
	pz	mq	kg	box	mq	kg
80x80	2	1,28	29,80	40	51,20	1220
40x80	3	0,96	22,00	56	53,76	1260
60x120	2	1,44	33,40	30	43,20	1030
60x60	3	1,08	25,10	40	43,20	1030
30x30 mosaico	11	1,00	23,00	30	30,00	720
21x40 modulo list.sfals.	5	0,42	9,70	40	16,80	410

LA ROCHE DI REX	scatola - box			pallet		
	pz	ml	kg	box	mq	kg
4,6x60 battiscopa	14	8,40	8,40	-	-	-

6 mm 1/4" ↑↓				30x30 $11\frac{4}{5}'' \times 11\frac{4}{5}''$  mosaico tessere 7,5x7,5 pz/box 11	30x30 $11\frac{4}{5}'' \times 11\frac{4}{5}''$  muretto tessere 7,5x15 pz/box 11	30x30 $11\frac{4}{5}'' \times 11\frac{4}{5}''$  mosaico tessere 1,5x3 pz/box 11
		COLOR	SURFACE			
LA ROCHE DI REX		LA ROCHE BLANC	SMOOTH	747765 ▲ FL-01800	747795 ▲ FL-01800	747818 ▲ FL-02700
		LA ROCHE ECRU	SMOOTH	747766 ▲ FL-01800	747796 ▲ FL-01800	747819 ▲ FL-02700
		LA ROCHE GREY	SMOOTH	747767 ▲ FL-01800	747797 ▲ FL-01800	747820 ▲ FL-02700

PEZZI SPECIALI/SPECIAL TRIMS/PIÈCES SPÉCIALES/FORMSTÜCKE/PIEZAS ESPECIALES/Специальные изделия

6 mm 1/4" ↑↓				4,6x80 $1\frac{4}{5}'' \times 3\frac{1}{2}''$  battiscopa
		COLOR	SURFACE	
LA ROCHE DI REX		LA ROCHE BLANC	SMOOTH	747880 ◆ FL-01800
		LA ROCHE ECRU	SMOOTH	747881 ◆ FL-01800
		LA ROCHE GREY	SMOOTH	747882 ◆ FL-01800

LA ROCHE DI REX OUTDOOR

Vantaggi tecnici - Technical advantages - Avantages techniques Technische Vorteile - Ventajas técnicas - Технические преимущества

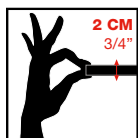

- Lastra monolitica compatta di spessore 2 cm squadrata e rettificata
- Compact monolithic slab 2 cm thick squared and rectified
- Dalle monolithique compacte de 2 cm d'épaisseur, équaree et rectifiée
- Kompakte monolithische Platte, 2 cm dick, rechteckig und scharfkantig geschliffen
- Losa monolítica compacta de 2 cm de espesor, escuadrada y rectificada.
- Монолитная плотная плита толщиной 2 см, с обрезанными и выровненными кромками

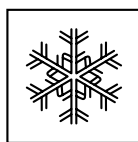

- INGELIVO
- FROST RESISTANT
- INGÉLIF
- FROSTBESTÄNDIG
- RESISTENTE A LA HELADA
- МОРОЗОСТОЙКАЯ



- ELEVATA RESISTENZA AI CARICHI STATICI
- HIGH STATIC LOAD RESISTANCE
- RÉSISTANCE ÉLEVÉE AUX CHARGES STATIQUES
- HOHE STATISCHE BELASTBARKEIT
- ELEVADA RESISTENCIA A LAS CARGAS ESTÁTICAS
- ВЫДЕРЖИВАЕТ БОЛЬШИЕ СТАТИЧЕСКИЕ НАГРУЗКИ

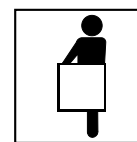

- FACILE DA POSARE
- EASY TO INSTALL
- FACILE À POSER
- VERLEGELEICHT
- FÁCIL DE COLOCAR
- ЛЕГКО УКЛАДЫВАЕТСЯ



- ANTISCIVOLO R11
- ANTI SLIP R11
- ANTIDÉRAPANT R11
- RUTSCHFEST R11
- ANTIDESLIZANTE R11
- НЕСКОЛЬЗКАЯ - R11

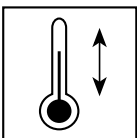

- RESISTENTE AGLI SBALZI TERMICI
- THERMAL SHOCK RESISTANT
- RÉSISTANT AUX ÉCARTS THERMIQUES
- TEMPERATURWECHSELBESTÄNDIG
- RESISTENTE A LAS OSCILACIONES TÉRMICAS
- СТОЙКАЯ К ТЕПЛОВЫМ ПЕРЕПАДАМ



- FACILE DA PULIRE
- EASY TO CLEAN
- FACILE À NETTOYER
- REINIGUNGSEICHT
- FÁCIL DE LIMPIAR
- ЛЕГКО ЧИСТИТСЯ

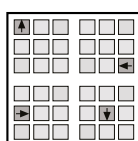

- RIMOVIBILE E RIUTILIZZABILE
- REMOVABLE AND REUSABLE
- DÉMONTABLE ET RÉUTILISABLE
- ENTFERNBAR UND WIEDERVERWENDBAR
- DESMONTABLE Y REUTILIZABLE
- МОЖЕТ СНИМАТЬСЯ И ПОВТОРНО ИСПОЛЬЗОВАТЬСЯ



- INATTACCABILE DA AGENTI CHIMICI E MUFFE
- IMPERVIUS TO ATTACK BY CHEMICALS OR MOULD
- RÉSISTANT AUX AGENTS CHIMIQUES ET AUX MOISSISSURES
- UNANGREIFBAR DURCH CHEMISCHE STOFFE UND SCHIMMEL
- RESISTENTE A LOS AGENTES QUÍMICOS Y A LOS MOHOS
- НЕ ПОДВЕРГАЕТСЯ ВОЗДЕЙСТВИЮ ХИМИЧЕСКИХ ВЕЩЕСТВ И ПЛЕСЕНИ

Applicazioni - Applications - Applications - Verlegung - Aplicaciones - Применения

- Posa diretta su erba
- Direct installation on grass
- Pose direct sur de l'herbe
- Verlegung direkt auf Rasen
- Colocación directa sobre hierba
- Прямая укладка на траву

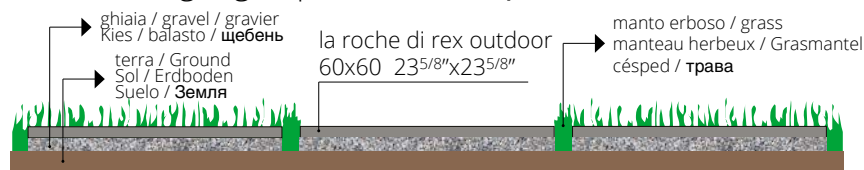

- Posa diretta su ghiaia
- Direct installation over gravel
- Pose direct sur du gravier
- Verlegung direkt auf Kies
- Colocación directa sobre grava
- Прямая укладка на гальку



- Posa su massetto cementizio
- Installation on sand-cement screed
- Pose sur chape ciment
- Verlegung auf Zement-Unterbetonblock
- Colocación sobre contrapiso de hormigón
- Укладка на цементную стяжку

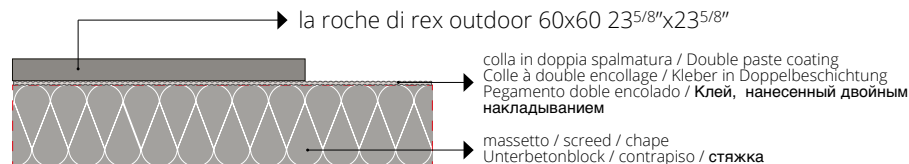

- Posa su piedini fissi o regolabili
- Installation on fixed or adjustable feet
- Pose sur pieds fixes ou réglables
- Verlegung auf feststehende oder regulierbare FüÙe
- Colocación sobre pies fijos o regulables
- Укладка на фиксированных или регулируемых ножках

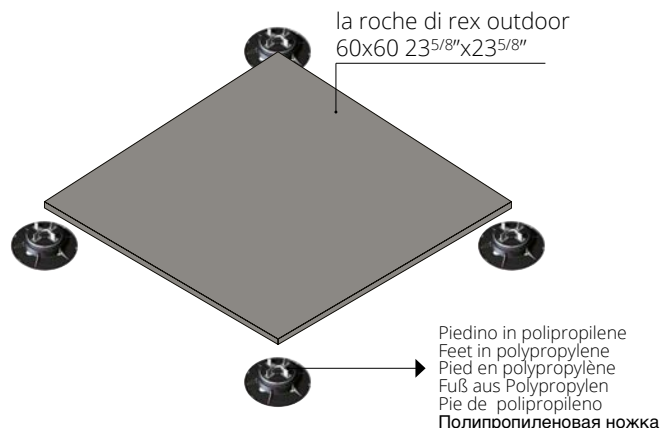

Per le specifiche di utilizzo dei sistemi sopraelevati vedi il sito florim.com
For the specifics on use of raised systems visit the site florim.com
Pour les caractéristiques d'utilisation des systèmes surélevés, voir le site florim.com
Für die Nutzungsbedingungen der Doppelbodensysteme siehe Webseite florim.com
Para las especificaciones de empleo de los sistemas sobreelevados consulte el sitio web florim.com
Технические характеристики систем фальшполов см. на сайте florim.com

Le lastre ceramiche sono sottoposte a un trattamento di compattazione termica che assicura resistenza e durata nel tempo. Il bassissimo assorbimento d'acqua rende perciò il materiale ingelivo. Ciò può comportare ristagni d'acqua superficiali anche per materiale installato a regola d'arte. / Ceramic tiles undergo a compacting thermal treatment that ensures resistance and durability. The low level of water absorption makes the slabs frost resistant. This could result in superficial water stagnations even if materials are installed in a workmanlike manner. / Les carreaux de céramique subissent un traitement thermique qui assure résistance et durabilité. Le bas niveau d'absorption d'eau rend les dalles résistant au gel. Il pourrait en résulter des stagnations d'eau superficielles, même si les dalles ont été installées dans les règles de l'art. / Die Keramikplatten werden einer thermischen Verdichtung unterzogen, welche die Widerstandsfähigkeit und Langlebigkeit sichert. Die extrem niedrige Wasseraufnahme macht das Material frostsicher. Die hohe Materialdichte kann, auch bei einer perfekten Verlegung, eine längere Abtrocknungszeit von angestaubtem Wasser zur Folge haben. / Las baldosas cerámicas se someten a un tratamiento de compactación térmica que asegura resistencia y durabilidad. La baja absorción de agua hace que las baldosas resistan al hielo. Esto podría resultar en estancamientos superficiales de agua, incluso si los materiales están instalados según las reglas del arte. / Керамическая плитка подвергается термическому уплотнению, что обеспечивает ей прочность и износостойкость. За счёт очень низкого водопоглощения она не промерзает, при этом даже при правильной укладке возможны застои воды на поверхности плитки.

LA ROCHE ECRU



LA ROCHE GREY



R11
(strutturato)
CLASSE
A+B

20 mm 3/4" ↑↓

GRES FINE PORCELLANATO

FINE PORCELAIN STONEWARE/GRES CERAME FIN/FEINSTEINZEUG-KOLLEKTIONEN/GRES PORCELANICO FINO/ФАРФОРОВЫЙ КЕРАМОГРАНИТ

SQUADRATO - SQUARED - EQUARRI - REKTIFIZIERT - ESCUADRADO - КАЛИБРОВАННАЯ

20 mm 3/4" ↑↓	COLOR	SURFACE	40x120 15 ^{3/4"} x47 ^{1/4"}	60x60 23 ^{5/8"} x23 ^{5/8"}
	LA ROCHE ECRU	STRUTTURATO	744631 ■ FL-10800	744629 ■ FL-07700
	LA ROCHE GREY	STRUTTURATO	744632 ■ FL-10800	744630 ■ FL-07700

LA ROCHE DI REX

	RESISTENZA ALLA FLESSIONE IN N/mm² N/mm ² FLEXURAL STRENGTH TEST / RESISTANCE A LA FLEXION EN N/mm ² / BIEGESTIGKEIT IN N/mm ² / RESISTENCIA A LA FLEXION EN N/mm ² / УСТОЙЧИВОСТЬ К ИЗГИБУ В Н/мм ²	valore medio 52 N/mm²
	Forza di rottura in N (sp. > 7,5 mm) Breaking strength in N (thickness > 7,5 mm) / Force de rupture en N (ép. > 7,5 mm) / Bruchlast in N (Dicke > 7,5 mm) / Fuerza de rotura en N (gr. > 7,5 mm) / Разрушающее усилие, Н (толщ. > 7,5 мм)	valore medio 14000 N



LA ROCHE DI REX	scatola - box			pallet		
	pz	mq	kg	box	mq	kg
40x120 20mm	2	0,96	43,10	24	23,04	1060
60x60 20mm	2	0,72	32,10	30	21,60	990

PEZZI SPECIALI

Special trims/Pièces spéciales/Formstücke
Piezas especiales/СПЕЦИАЛЬНЫЕ ИЗДЕЛИЯ
pag 188/193



LES BIJOUX DE REX

gres porcellanato colorato in massa
coloured body porcelain stoneware
grès cérame colore dans la masse
durchgefärbte feinsteinzeug
gres porcelánico coloreado en masa
керамогранит, окращенный по всей толщине





LES BIJOUX REX

Proseguendo la singolare e seducente proposta di Étoile de Rex, la collezione **Les Bijoux de Rex** trova la propria ispirazione in fonti diverse ma tutte di respiro artistico, inteso in un ampio significato: nobili minerali abilmente lavorati per la creazione di ricercati gioielli artigianali, meravigliosi marmi utilizzati nella realizzazione di importanti architetture e sculture, persino dipinti di celebri artisti. Se l'arte stessa attribuisce valore all'espressione estetica e a qualsiasi forma di creatività in grado di trasmettere emozioni e messaggi "soggettivi", che possano essere interiorizzati e interpretati dall'individuo, l'essenza di questa collezione risiede proprio nella possibilità di comunicare un fascino artistico attraverso lo stile e la grande forza espressiva tipica del marchio Rex. Da questo interessante binomio nascono prodotti avvolgenti e dalle cromie molto originali.

In the same vein as the unique and alluring proposal of Étoile de Rex, the inspiration behind the collection **Les Bijoux de Rex** comes from sources that are different yet all with an artistic reach, in its widest sense: prized minerals skilfully crafted to make refined handmade jewels, magnificent marbles used in the creation of important architecture and sculptures, even paintings by famous artists. If art itself places value on aesthetic expression and any form of creativity able to convey emotions and "subjective" messages, which can be internalized and interpreted by the individual, the essence of this collection lies in its ability to convey an artistic allure through the style and the great eloquence typical of the Rex brand. This interesting pairing gives life to enveloping products with truly original colours.

C'est en poursuivant la proposition singulière et séduisante d'Étoile de Rex que la collection **Les Bijoux de Rex** trouve son inspiration dans des sources différentes mais toutes artistiques, au sens large du terme: des minéraux nobles travaillés pour la création de bijoux artisanaux raffinés, des marbres merveilleux utilisés dans la réalisation d'architectures et de sculptures importantes, voire même des tableaux d'artistes célèbres. Si l'art lui-même valorise l'expression esthétique et toute forme de créativité en mesure de transmettre des émotions et des messages « subjectifs », que l'individu peut intérioriser et interpréter, l'essence de cette collection réside précisément dans la possibilité de communiquer un charme artistique à travers le style et la grande force d'expression typique de la marque Rex. C'est de ce binôme intéressant que naissent des produits enveloppants aux couleurs très originales.

Die Kollektion **Les Bijoux de Rex** setzt das einzigartige, verführerische Angebot von Étoile de Rex fort und findet ihre Inspiration in verschiedenen Quellen, die aber alle künstlerisch angehaucht sind und in einer breit angelegten Bedeutung zu verstehen sind: edle Mineralien, die für auserlesene handgefertigte Schmuckobjekte verarbeitet werden, wunderbare Marmore, die zur Schaffung wichtiger architektonischer Baulösungen und Skulpturen eingesetzt werden, und sogar Gemälde berühmter Künstler. Wenn gar die Kunst dem ästhetischen Ausdruck und jeder Form von Kreativität den Wert beimisst, „subjektive“ Erlebnisse und Botschaften herbeizuführen, die vom Menschen verinnerlicht und gedeutet werden können, so liegt das Wesen dieser Kollektion genau darin, durch den Stil und die große Ausdruckskraft - die für die Marke Rex ein typisches Merkmal ist - einen künstlerischen Charme zu vermitteln. Aus dieser interessanten Kombination entstehen umhüllende Produkte, deren Farbtöne von großer Originalität zeugen.

Continuando con la singular y seductora propuesta de Étoile de Rex, la colección **Les Bijoux de Rex** encuentra su propia inspiración en fuentes distintas, aunque todas con un toque artístico entendido en un amplio significado: minerales nobles elaborados con maestría para la creación de joyas artesanales sofisticadas, mármoles maravillosos utilizados en la realización de importantes arquitecturas, esculturas e incluso cuadros de artistas célebres. Si el arte ensi atribuye valor a la expresión estética y a cualquier forma de creatividad capaz de transmitir emociones y mensajes "subjetivos" que puedan ser interiorizados e interpretados por las personas, la esencia de esta colección reside precisamente en la posibilidad de comunicar un encanto artístico a través del estilo y la gran fuerza expresiva típica de la marca Rex. De esta interesante combinación nacen productos cautivadores y con tonos muy originales.

Продолжая единственное в своем роде и увлекательное предложение Étoile от Rex, коллекция **Les Bijoux de Rex** находит свое выражение в разных источниках, но все из них - в художественном духе в широком смысле: ценные минералы с мастерской обработкой для создания изысканных ремесленных драгоценных украшений и удивительные сорта мрамора используются в создании важных архитектурных и скульптурных работ, даже для картин известных художников. Если само искусство наделяет ценностью эстетическое выражение и любую форму креативности, способную дарить эмоции и субъективные ощущения, которые индивидуум способен усвоить и переосмыслить, то сущность этой коллекции заключается именно в возможности передавать художественное очарование через стиль и большую выразительную силу, характерную для бренда Rex. На основе этого интересного сочетания появляются на свет деликатные изделия с очень оригинальными цветами.

LES BIJOUX DE REX

CALACATTA ALTISSIMO BLANC ONYX BLANCHE



10 mm 3/8" ↑↓

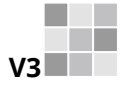

6 mm 1/4" ↑↓

FLORIM OVERSIZE
magnUlm

GRES PORCELLANATO COLORATO IN MASSA/COLOURED BODY PORCELAIN STONEWARE
GRÈS CÉRAME COLORE DANS LA MASSE/DURCHGEFÄRBTE FEINSTEINZEUG/GRES PORCELÁNICO COLOREADO EN MASA/керамогранит, окращенный по всей тлщине
SQUADRATO - SQUARED - EQUARRI - REKTIFIZIERT - ESCUADRADO - КАЛИБРОВАННАЯ

10 mm 3/8" ↑↓		COLOR	SURFACE	80x180 31 1/2" x 70 6/7"	80x80 31 1/2" x 31 1/2"	40x80 15 3/4" x 31 1/2"	60x120 23 5/8" x 47 1/4"	60x60 23 5/8" x 23 5/8"
LES BIJOUX DE REX		CALACATTA ALTISSIMO BLANC	GLOSSY	766091 ■ FL-11900	766365 ■ FL-10800	766368 ■ FL-09100	766330 ■ FL-11300	766342 ■ FL-09100
			MATTE	766086 ■ FL-10500	766364 ■ FL-09300	766367 ■ FL-07300	766329 ■ FL-09900	766339 ■ FL-07300
		ONYX BLANCHE	GLOSSY	766090 ■ FL-11900	766363 ■ FL-10800	766361 ■ FL-09100	766328 ■ FL-11300	766338 ■ FL-09100
			MATTE	766085 ■ FL-10500	766362 ■ FL-09300	766360 ■ FL-07300	766325 ■ FL-09900	766337 ■ FL-07300
6 mm 1/4" ↑↓		COLOR	SURFACE	120x280 47 1/4" x 110 1/4"	120x240 47 1/4" x 94 1/2"	120x120 47 1/4" x 47 1/4"	60x120 23 5/8" x 47 1/4"	
LES BIJOUX DE REX		CALACATTA ALTISSIMO BLANC	GLOSSY	765697 ■ FL-15100	765721 ■ FL-14000	765759 ■ FL-12400	765781 ■ FL-11300	
			MATTE	765682 ■ FL-12400	765713 ■ FL-11300	765751 ■ FL-09700	765773 ■ FL-09100	
		ONYX BLANCHE	GLOSSY	765693 ■ FL-15100	765720 ■ FL-14000	765758 ■ FL-12400	765780 ■ FL-11300	
			MATTE	765680 ■ FL-12400	765704 ■ FL-11300	765750 ■ FL-09700	765768 ■ FL-09100	

OMBRE DE CARAVAGE

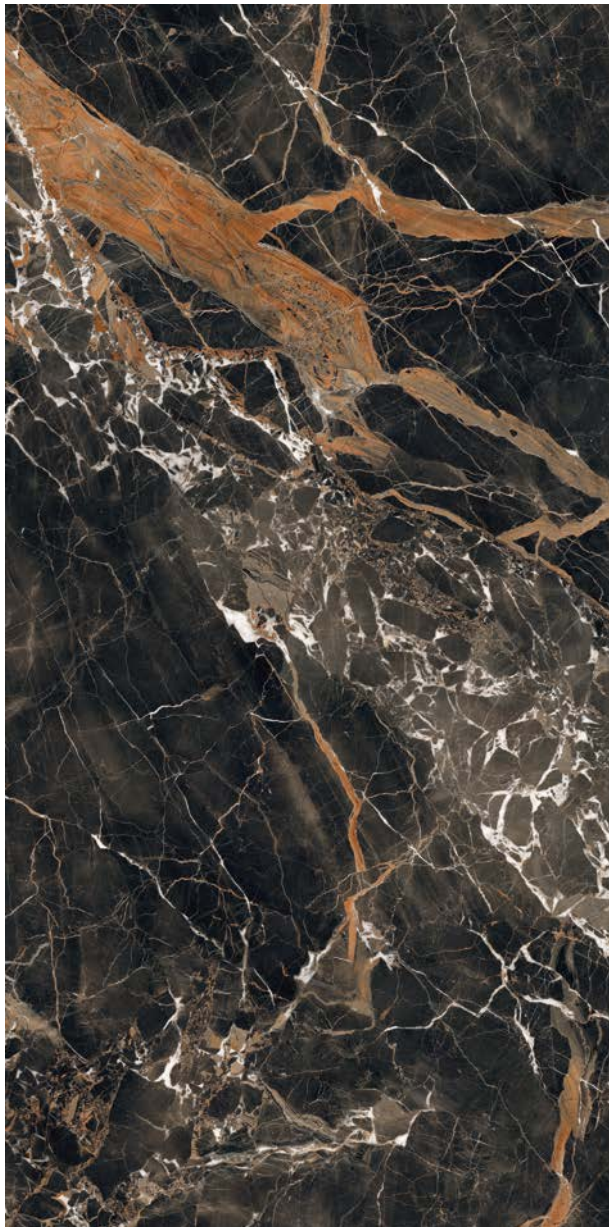

BRÈCHE CAPRAIA



V3
DCOF>
0,42 Wet
(ombre de
caravage
matte)

10 mm 3/8" ↑↓



V3
DCOF>
0,42 Wet
(ombre de
caravage
matte)

6 mm 1/4" ↑↓

FLORM OVERSIZE
magnUm

GRES PORCELLANATO COLORATO IN MASSA/COLOURED BODY PORCELAIN STONEWARE
GRÈS CÉRAME COLORE DANS LA MASSE/DURCHGEFÄRBTE FEINSTEINZEUG/GRES PORCELÁNICO COLOREADO EN MASA/керамогранит, окрашенный по всей тлщине
SQUADRATO - SQUARED - EQUARRI - REKTIFIZIERT - ESCUADRADO - КАЛИБРОВАННАЯ

			10 mm 3/8" ↑↓					
		COLOR	SURFACE	80x180 31 1/2" x 70 5/8"	80x80 31 1/2" x 31 1/2"	40x80 15 3/4" x 31 1/2"	60x120 23 5/8" x 47 1/4"	60x60 23 5/8" x 23 5/8"
LES BIJOUX DE REX		OMBRE DE CARAVAGE	GLOSSY	766093 ■ FL-11900	766366 ■ FL-10800	766370 ■ FL-09100	766332 ■ FL-11300	766341 ■ FL-09100
			MATTE	766088 ■ FL-10500	766485 ■ FL-09300	766369 ■ FL-07300	766331 ■ FL-09900	766340 ■ FL-07300
		BRÈCHE CAPRAIA	GLOSSY	766092 ■ FL-11900	766375 ■ FL-10800	766372 ■ FL-09100	766333 ■ FL-11300	766344 ■ FL-09100
			MATTE	766087 ■ FL-10500	766486 ■ FL-09300	766371 ■ FL-07300	766334 ■ FL-09900	766343 ■ FL-07300

			6 mm 1/4" ↑↓				
		COLOR	SURFACE	120x280 47 1/4" x 110 1/4"	120x240 47 1/4" x 94 1/2"	120x120 47 1/4" x 47 1/4"	60x120 23 5/8" x 47 1/4"
LES BIJOUX DE REX		OMBRE DE CARAVAGE	GLOSSY	765698 ■ FL-15100	765723 ■ FL-14000	765761 ■ FL-12400	765782 ■ FL-11300
			MATTE	765683 ■ FL-12400	765714 ■ FL-11300	765752 ■ FL-09700	765774 ■ FL-09100
		BRÈCHE CAPRAIA	GLOSSY	765699 ■ FL-15100	765724 ■ FL-14000	765762 ■ FL-12400	765783 ■ FL-11300
			MATTE	765684 ■ FL-12400	765715 ■ FL-11300	765753 ■ FL-09700	765775 ■ FL-09100

LES BIJOUX DE REX

MARRON IMPERIAL

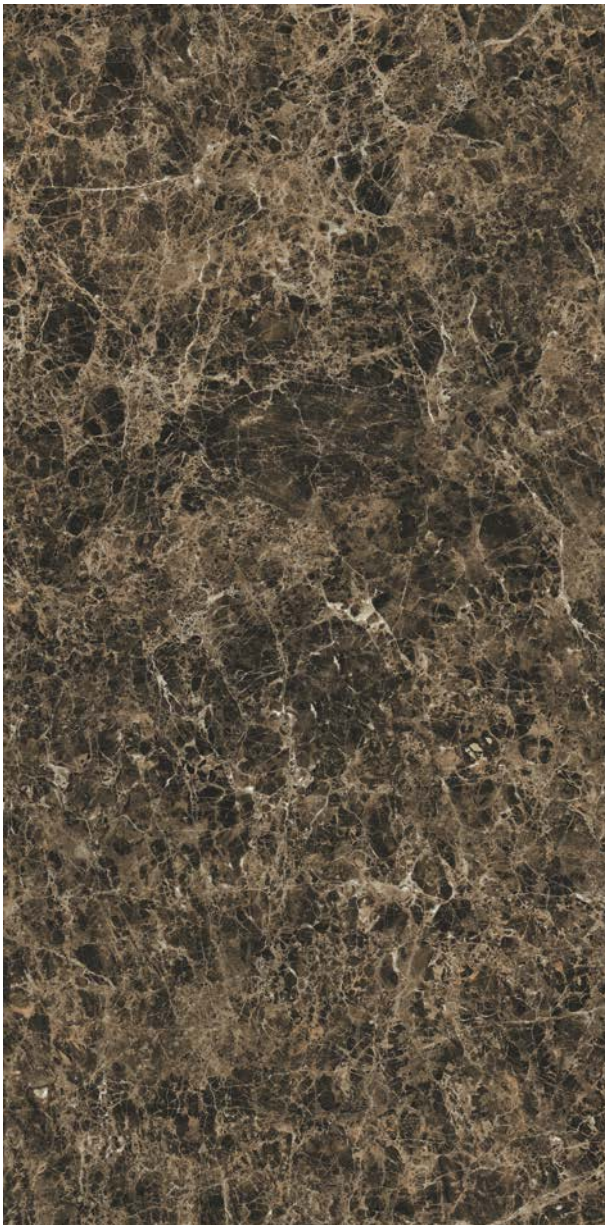

JASPE ROUGE

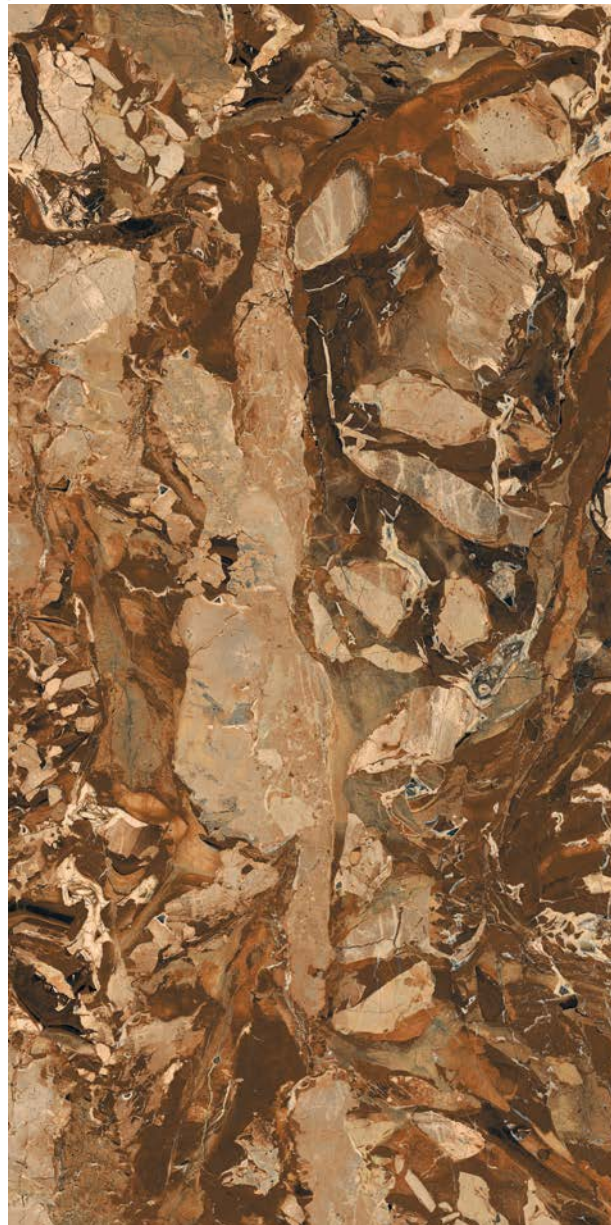

V3
DCOF >
0,42 Wet
(matte)

10 mm 3/8" ↑↓





V3
DCOF >
0,42 Wet
(matte)

6 mm 1/4" ↑↓

FLOHM OVERSIZE
magnum

GRES PORCELLANATO COLORATO IN MASSA/COLOURED BODY PORCELAIN STONEWARE
GRÈS CÉRAME COLORE DANS LA MASSE/DURCHGEFÄRBTE FEINSTEINZEUG/GRES PORCELÁNICO COLOREADO EN MASA/керамогранит, окращенный по всей тлщине
SQUADRATO - SQUARED - EQUARRI - REKTIFIZIERT - ESCUADRADO - КАЛИБРОВАННАЯ

			10 mm 3/8" ↑↓			80x180 31 1/2" x 70 6/7"	80x80 31 1/2" x 31 1/2"	40x80 15 3/4" x 31 1/2"	60x120 23 5/8" x 47 1/4"	60x60 23 5/8" x 23 5/8"
LES BIJOUX DE REX		MARRON IMPERIAL	GLOSSY	766094 ■ FL-11900	766376 ■ FL-10800	766374 ■ FL-09100	766335 ■ FL-11300	766346 ■ FL-09100		
			MATTE	766089 ■ FL-10500	766487 ■ FL-09300	766373 ■ FL-07300	766336 ■ FL-09900	766345 ■ FL-07300		

			6 mm 1/4" ↑↓			120x280 47 1/4" x 110 1/4"	120x240 47 1/4" x 94 1/2"	120x120 47 1/4" x 47 1/4"	60x120 23 5/8" x 47 1/4"
LES BIJOUX DE REX		MARRON IMPERIAL	GLOSSY	765700 ■ FL-15100	765725 ■ FL-14000	765763 ■ FL-12400	765784 ■ FL-11300		
			MATTE	765685 ■ FL-12400	765716 ■ FL-11300	765754 ■ FL-09700	765776 ■ FL-09100		
		JASPE ROUGE	GLOSSY	765701 ■ FL-15100	765726 ■ FL-14000	765764 ■ FL-12400	765785 ■ FL-11300		
			MATTE	765686 ■ FL-12400	765717 ■ FL-11300	765755 ■ FL-09700	765777 ■ FL-09100		

SODALITE BLEU





LES QUATRE SAISONS









DCOF >
0,42 Wet
(sodalite bleu matte)





GRES PORCELLANATO COLORATO IN MASSA/COLOURED BODY PORCELAIN STONEWARE
GRÈS CÉRAMÉ COLORE DANS LA MASSE/DURCHGEFÄRBT FEINSTEINZEUG/GRES PORCELÁNICO COLOREADO EN MASA/керамогранит, окрашенный по всей толщине
SQUADRATO - SQUARED - EQUARRI - REKTIFIZIERT - ESCUADRADO - КАЛИБРОВАННАЯ

6 mm 1/4" ↑↓		COLOR	SURFACE	120x280 47 ^{1/4"} x110 ^{1/4"}	120x240 47 ^{1/4"} x94 ^{1/2"}	120x120 47 ^{1/4"} x47 ^{1/4"}	60x120 23 ^{5/8"} x47 ^{1/4"}
LES BIJOUX DE REX		SODALITE BLEU	GLOSSY	765702 ■ FL-15100	765727 ■ FL-14000	765765 ■ FL-12400	765786 ■ FL-11300
			MATTE	765690 ■ FL-12400	765718 ■ FL-11300	765756 ■ FL-09700	765778 ■ FL-09100
		LES QUATRE SAISONS	GLOSSY	765703 ■ FL-15100	765728 ■ FL-14000	765767 ■ FL-12400	765787 ■ FL-11300
			MATTE	765691 ■ FL-12400	765719 ■ FL-11300	765757 ■ FL-09700	765779 ■ FL-09100

LES BIJOUX DE REX

10 mm 3/8" ↓		COLOR	SURFACE	30x30 11 ^{4/5"} x11 ^{4/5"}  mosaico tessere 3x15 pz/box 11	30x30 11 ^{4/5"} x11 ^{4/5"}  mosaico 3D Mix tessere 3x3 pz/box 9
LES BIJOUX DE REX		CALACATTA ALTISSIMO BLANC	GLOSSY	767570 ▲ FL-02200	767565 ▲ FL-04900
			MATTE	767575 ▲ FL-02100	
		ONYX BLANCHE	GLOSSY	767569 ▲ FL-02200	767564 ▲ FL-04900
			MATTE	767574 ▲ FL-02100	
		OMBRE DE CARAVAGE	GLOSSY	767571 ▲ FL-02200	767566 ▲ FL-04900
			MATTE	767576 ▲ FL-02100	
		BRÈCHE CAPRAIA	GLOSSY	767572 ▲ FL-02200	767567 ▲ FL-04900
			MATTE	767577 ▲ FL-02100	
		MARRON IMPERIAL	GLOSSY	767573 ▲ FL-02200	767568 ▲ FL-04900
			MATTE	767578 ▲ FL-02100	

PEZZI SPECIALI/SPECIAL TRIMS/
PIÈCES SPÉCIALES/FORMSTÜCKE
PIEZAS ESPECIALES/Специальные изделия

4,6x60 1 ^{4/5"} x23 ^{5/8"}  battiscopa	33x120x3 13 ^{1/4"} x47 ^{1/4"} x1 ^{1/8"}  gradino pz/box 2
767580 ◆ FL-01600	767590 ▲ FL-22600
767585 ◆ FL-01600	767595 ▲ FL-20400
767579 ◆ FL-01600	767589 ▲ FL-22600
767584 ◆ FL-01600	767594 ▲ FL-20400
767581 ◆ FL-01600	767591 ▲ FL-22600
767586 ◆ FL-01600	767596 ▲ FL-20400
767582 ◆ FL-01600	767592 ▲ FL-22600
767587 ◆ FL-01600	767597 ▲ FL-20400
767583 ◆ FL-01600	767593 ▲ FL-22600
767588 ◆ FL-01600	767598 ▲ FL-20400











In relazione alle differenti tecnologie produttive l'accostamento di prodotti con spessori diversi potrebbe presentare delle disomogeneità, se ne sconsiglia pertanto l'abbinamento. / Due to the different production technologies, contiguous installation of products with different thickness may give a non-homogeneous result. For this reason we do not recommend this option. / Vu que différentes technologies de production sont utilisées avec des épaisseurs différentes, des problèmes d'homogénéité pourraient se présenter, il est donc déconseillé de les poser ensemble. / Wegen unterschiedlicher Produktionstechnologien können die Fliesen mit verschiedenen Materialstärken optische Differenzen aufweisen. Von einem direkten Aneinanderlegen wird deshalb abgeraten. / Dadas las diferentes tecnologías productivas, la combinación de productos de diferentes espesores podría dar lugar a heterogeneidad, por lo que se desaconseja mezclarlos. / В связи с различием в технологиях производства, сочетание продукции разной толщины иногда может представлять неоднородность материала. Такие сочетания следует избегать.

Per un effetto ottimale della posa, florim suggerisce di mantenere 2 mm di fuga per pose monofornate e 3 mm per combinare formati misti. - For optimal installation results, florim recommends maintaining a joint of 2 mm - 1/16" for single format installations and 3 mm - 1/8" to combine mixed formats. - Pour réaliser une pose parfaite, florim suggère de maintenir 2 mm de joint pour la pose des monofornats, et 3 mm pour les combinaisons de formats mixtes. - Um einen optimalen effekt beim verlegen zu erzielen empfiehlt florim eine 2 mm fugе bei einformatigen verlegungen und 3 mm fugе bei formatkombinationen Para lograr los máximos resultados en la posa del producto, florim aconseja 2 mm de junta en aplicaciones monofornato y 3 mm en combinaciones de formatos mixtos - ДЛЯ ОПТИМАЛЬНОЙ УКЛАДКИ - FLORIM® РЕКОМЕНДУЕТ ВЫДЕРЖИВАТЬ ЗАЗОР 2 ММ ДЛЯ МОНОФОРМАТА И 3 ММ ПРИ СМЕШАННЫХ ФОРМАТАХ.

LES BIJOUX DE REX	scatola - box			pallet		
	pz	mq	kg	box	mq	kg
80x180	2	2,88	67,20	20	57,60	1400
80x80	2	1,28	29,80	40	51,20	1220
40x80	3	0,96	22,00	28	26,88	640
60x120	2	1,44	31,70	30	43,20	980
60x60	3	1,08	23,80	40	43,20	980

LES BIJOUX DE REX	scatola - box			pallet		
	pz	ml	kg	box	mq	kg
4,6x60 battiscopa	14	8,40	8,40	-	-	-

6 mm 1/4" ↑↓

		COLOR	SURFACE	30x30 11 ^{4/5} "x11 ^{4/5} "  mosaico tessere 7,5x7,5 pz/box 11	30x30 11 ^{4/5} "x11 ^{4/5} "  muretto tessere 7,5x15 pz/box 11
LES BIJOUX DE REX		CALACATTA ALTISSIMO BLANC	GLOSSY	767616 ▲ FL-02100	767600 ▲ FL-02100
			MATTE	767624 ▲ FL-01800	767608 ▲ FL-01800
		ONYX BLANCHE	GLOSSY	767615 ▲ FL-02100	767599 ▲ FL-02100
			MATTE	767623 ▲ FL-01800	767607 ▲ FL-01800
		OMBRE DE CARAVAGE	GLOSSY	767617 ▲ FL-02100	767601 ▲ FL-02100
			MATTE	767625 ▲ FL-01800	767609 ▲ FL-01800
		BRÈCHE CAPRAIA	GLOSSY	767618 ▲ FL-02100	767602 ▲ FL-02100
			MATTE	767626 ▲ FL-01800	767610 ▲ FL-01800
		MARRON IMPERIAL	GLOSSY	767619 ▲ FL-02100	767603 ▲ FL-02100
			MATTE	767627 ▲ FL-01800	767611 ▲ FL-01800
		JASPE ROUGE	GLOSSY	767620 ▲ FL-02100	767604 ▲ FL-02100
			MATTE	767628 ▲ FL-01800	767612 ▲ FL-01800
		SODALITE BLEU	GLOSSY	767621 ▲ FL-02100	767605 ▲ FL-02100
			MATTE	767629 ▲ FL-01800	767613 ▲ FL-01800
		LES QUATRE SAISONS	GLOSSY	767622 ▲ FL-02100	767606 ▲ FL-02100
			MATTE	767630 ▲ FL-01800	767614 ▲ FL-01800

PEZZI SPECIALI/SPECIAL TRIMS/
PIÈCES SPÉCIALES/FORMSTÜCKE
PIEZAS ESPECIALES/Специальные изделия

4,6x80 1 ^{4/5} "x3 ^{1/2} "  battiscopa
767632 ◆ FL-01800
767637 ◆ FL-01800
767631 ◆ FL-01800
767636 ◆ FL-01800
767633 ◆ FL-01800
767638 ◆ FL-01800
767634 ◆ FL-01800
767639 ◆ FL-01800
767635 ◆ FL-01800
767640 ◆ FL-01800
-
-
-
-
-

FLOHM OVERSIZE
magnUm

120x280/120x240/120x120/60x120

Specifica Imballo pag.
Packaging specifications on page
Spécifications d'emballage à page
Verpackungsdetail Seite
Especificaciones de embalaje a la página
Информация об упаковке на стр.
200/201

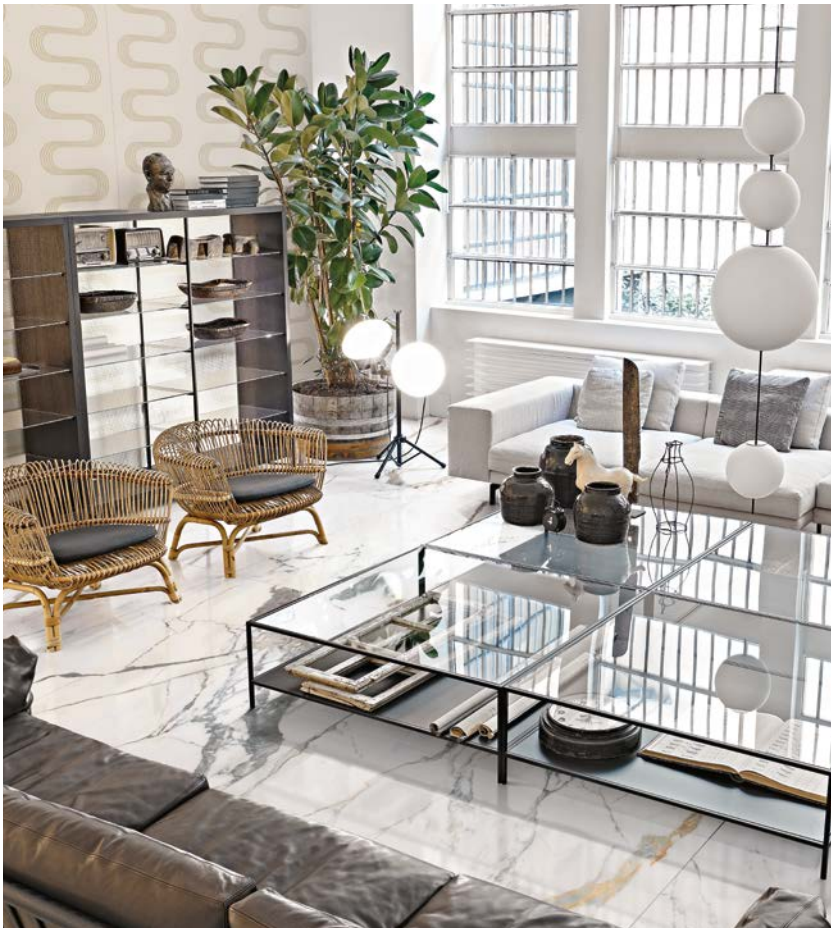

LES ORIGINES DE REX

gres porcellanato colorato in massa
coloured body porcelain stoneware
grès cérame colore dans la masse
durchgefärbte feinsteinzeug
gres porcelánico coloreado en masa
керамогранит, окращенный по всей тлщине





LES ORIGINES DE REX

Nel lungo e stimolante percorso di ricerca tra le superfici di eterna bellezza, Rex ha incontrato le materie più preziose e talvolta inaccessibili che la natura possa offrire. Tra queste il marmo bianco da sempre simbolo di purezza, icona di prestigio ed eleganza. **Les Origines de Rex** esplora l'estremo candore di questa limpida materia esaltandolo con nuove declinazioni estetiche che si addicono perfettamente al lifestyle contemporaneo. Quattro raffinate variazioni grafiche impreziosiscono la sua naturale lucentezza con venature armoniche ma decise. Oro antico, avorio, grigio perlato fanno risaltare la sua forte anima cristallina che porta con sé la seducente eredità di una cultura secolare in grado di evocare valori estetici che sfidano il tempo e le mode.

On its long and exhilarating quest amid timeless and beautiful surfaces, Rex has discovered the most precious and often inaccessible materials that nature has to offer. Among these, white marble: the quintessential symbol of purity, an icon of prestige and elegance. **Les Origines de Rex** explores the extreme whiteness of this limpid material, enhancing it with new aesthetic variations that are perfectly suited to a contemporary lifestyle. Four refined pattern variations embellish its natural shine with harmonious yet bold veins. Antique gold, ivory and pearl grey highlight its vibrant crystalline soul, embodying the seductive heritage of a secular culture whose aesthetic values openly challenge time and fashions.

Dans le long et stimulant voyage de recherche entre les surfaces d'une beauté éternelle, Rex a rencontré les matériaux les plus précieux et parfois inaccessibles que la nature peut offrir. Parmi ceux-ci, le marbre blanc a toujours été un symbole de pureté, une icône de prestige et d'élégance. La collection « **Les Origines de Rex** » explore l'extrême blancheur de cette matière limpide, en l'enrichissant de nouvelles déclinaisons esthétiques, parfaitement adaptées au style de vie contemporain. Quatre variations graphiques raffinées agrémentent son éclat naturel de veines à la fois harmonieuses et marquées. L'or ancien, l'ivoire et le gris perle font ressortir sa puissante âme cristalline dont l'héritage séduisant est celui d'une culture séculaire capable d'évoquer des valeurs esthétiques qui défient le temps et la mode.

Auf dem langen und anregenden Forschungsparcours ewig schöner Oberflächen ist Rex den kostbarsten und manchmal unzugänglichsten Materialien begegnet, die die Natur bieten kann. Darunter auch dem weißen Marmor, der schon immer das Symbol von Reinheit und eine Ikone des Prestige und der Eleganz ist. **Les Origines de Rex** erforscht das extrem reine Weiß dieses klaren Materials und hebt es mit neuen ästhetischen Deklinationen hervor, die perfekt zum zeitgenössischen Lebensstil passen. Vier raffinierte grafische Variationen bereichern seinen natürlichen Glanz mit harmonischen aber entschlossenen Äderungen. Antikgold, Elfenbein, Perlgrau heben sein starkes kristallklares Wesen hervor, das jenes verführerische Erbe einer jahrhundertealten Kultur mit sich bringt, deren ästhetischen Werte das Verstreichen der Zeit und der Moden herausfordert.

En su larga y estimulante trayectoria de búsqueda entre las superficies de belleza eterna, Rex ha encontrado las materias más preciosas y a veces inaccesibles que ofrece la naturaleza. Entre ellas se encuentra el mármol blanco, que desde siempre simboliza la pureza y es un icono de prestigio y elegancia. **Les Origines de Rex** explora el sumo candor de esta materia límpida y lo realza con nuevas declinaciones estéticas que se adecuan perfectamente al estilo de vida contemporáneo. Cuatro elegantes variaciones gráficas embellecen su brillo natural con vetas armónicas pero audaces. El oro antiguo, el marfil y el gris perla ponen de relieve su fuerte espíritu cristalino, que lleva consigo el seductor legado de una cultura secolar, capaz de evocar valores estéticos que trascienden el tiempo y las modas.

В своем долгом и увлекательном поиске поверхностей, обладающих непреходящей красотой, Rex обнаружил самые драгоценные и порой недосыгаемые материалы, которые нам дарит природа. Среди них – белый мрамор, испокон веков являющийся символом чистоты, роскоши и элегантности. Коллекция **Les Origines de Rex** исследует необыкновенную белизну этого чистого материала, делая его еще красивее в новых эстетических вариациях, идеально вписывающихся в современный стиль жизни. Четыре варианта изысканной имитации рисунка дополняют естественный блеск мрамора, передавая гармоничный и в то же время решительный характер его прожилок. Цвета старое золото, слоновая кость и жемчужно-серый подчеркивают его кристально чистую сущность, в которой заключено очарование многовекового культурного наследия с его эстетическими ценностями, неподвластными времени и веяниям моды.

LES ORIGINES DE REX

ORIGINES OR



ORIGINES ARGENT

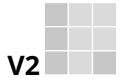

V2
DCOF >
0,42 Wet
(matte)

10 mm 3/8" ↑↓

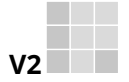

V2
DCOF >
0,42 Wet
(matte)

6 mm 1/4" ↑↓

FLORM OVERSIZE
magnUm

GRES PORCELLANATO COLORATO IN MASSA/COLOURED BODY PORCELAIN STONEWARE
GRÈS CÉRAME COLORE DANS LA MASSE/DURCHGEFÄRBTE FEINSTEINZEUG/GRES PORCELÁNICO COLOREADO EN MASA/керамогранит, окрашенный по всей глщине
SQUADRATO - SQUARED - EQUARRI - REKTIFIZIERT - ESCUADRADO - КАЛИБРОВАНАЯ

10 mm 3/8" ↑↓		COLOR	SURFACE	80x180 31 1/2" x 70 6/7"	60x120 23 5/8" x 47 1/4"	60x60 23 5/8" x 23 5/8"	30x60 11 4/5" x 23 5/8"	
LES ORIGINES DE REX		ORIGINES OR	GLOSSY	770437 ■ FL-11900	769858 ■ FL-11300	769842 ■ FL-09100	769850 ■ FL-07700	
			MATTE	770433 ■ FL-10500	769854 ■ FL-09900	769838 ■ FL-07300	769846 ■ FL-06200	
		ORIGINES ARGENT	GLOSSY	770438 ■ FL-11900	769859 ■ FL-11300	769843 ■ FL-09100	769851 ■ FL-07700	
			MATTE	770434 ■ FL-10500	769855 ■ FL-09900	769839 ■ FL-07300	769847 ■ FL-06200	
10 mm 1/4" ↑↓		COLOR	SURFACE	160x320 63" x 126"	120x280 47 1/4" x 110 1/4"	120x240 47 1/4" x 94 1/2"	120x120 47 1/4" x 47 1/4"	60x120 23 5/8" x 47 1/4"
LES ORIGINES DE REX		ORIGINES OR	GLOSSY	769953 ■ FL-18800	769978 ■ FL-15100	769970 ■ FL-14000	769962 ■ FL-12400	769986 ■ FL-11300
			MATTE	769949 ■ FL-15600	769974 ■ FL-12400	769966 ■ FL-11300	769958 ■ FL-09700	769982 ■ FL-09100
		ORIGINES ARGENT	GLOSSY	769950 ■ FL-18800	769975 ■ FL-15100	769967 ■ FL-14000	769959 ■ FL-12400	769983 ■ FL-11300
			MATTE	769946 ■ FL-15600	769971 ■ FL-12400	769963 ■ FL-11300	769955 ■ FL-09700	769979 ■ FL-09100

ORIGINES BLANC



ORIGINES OMBRE DORÉE

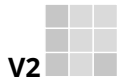

V2
DCOF>
0,42 Wet
(matte)

10 mm 3/8" ↑↓

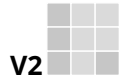

V2
DCOF>
0,42 Wet
(matte)

6 mm 1/4" ↑↓

FLORM OVERSIZE
magnUm

GRES PORCELLANATO COLORATO IN MASSA/COLOURED BODY PORCELAIN STONEWARE
GRÈS CÉRAME COLORE DANS LA MASSE/DURCHGEFÄRBTE FEINSTEINZEUG/GRES PORCELÁNICO COLOREADO EN MASA/керамогранит, окрашенный по всей тлщине
SQUADRATO - SQUARED - EQUARRI - REKTIFIZIERT - ESCUADRADO - КАЛИБРОВАНАЯ

10 mm 3/8" ↑↓		COLOR	SURFACE	80x180 31 1/2"x70 6/7"	60x120 23 5/8"x47 1/4"	60x60 23 5/8"x23 5/8"	30x60 11 4/5"x23 5/8"	
LES ORIGINES DE REX		ORIGINES BLANC	GLOSSY	770439 ■ FL-11900	769860 ■ FL-11300	769844 ■ FL-09100	769852 ■ FL-07700	
			MATTE	770435 ■ FL-10500	769856 ■ FL-09900	769840 ■ FL-07300	769848 ■ FL-06200	
		ORIGINES OMBRE DORÉE	GLOSSY	770440 ■ FL-11900	769861 ■ FL-11300	769845 ■ FL-09100	769853 ■ FL-07700	
			MATTE	770436 ■ FL-10500	769857 ■ FL-09900	769841 ■ FL-07300	769849 ■ FL-06200	
6 mm 1/4" ↑↓		COLOR	SURFACE	160x320 63"x126"	120x280 47 1/4"x110 1/4"	120x240 47 1/4"x94 1/2"	120x120 47 1/4"x47 1/4"	60x120 23 5/8"x47 1/4"
LES ORIGINES DE REX		ORIGINES BLANC	GLOSSY	769952 ■ FL-18800	769977 ■ FL-15100	769969 ■ FL-14000	769961 ■ FL-12400	769985 ■ FL-11300
			MATTE	769948 ■ FL-15600	769973 ■ FL-12400	769965 ■ FL-11300	769957 ■ FL-09700	769981 ■ FL-09100
		ORIGINES OMBRE DORÉE	GLOSSY	769951 ■ FL-18800	769976 ■ FL-15100	769968 ■ FL-14000	769960 ■ FL-12400	769984 ■ FL-11300
			MATTE	769947 ■ FL-15600	769972 ■ FL-12400	769964 ■ FL-11300	769956 ■ FL-09700	769980 ■ FL-09100

LES ORIGINES DE REX

10 mm 3/8" ↑↓		COLOR	SURFACE	30x30 11 ^{4/5"} x11 ^{4/5"} mosaico tessere 3x15 pz/box 11	30x30 11 ^{4/5"} x11 ^{4/5"} mosaico 3D Mix tessere 3x3 pz/box 9
LES ORIGINES DE REX		ORIGINES OR	GLOSSY	770358 ▲ FL-02200	770350 ▲ FL-04900
			MATTE	770354 ▲ FL-02100	
		ORIGINES ARGENT	GLOSSY	770355 ▲ FL-02200	770347 ▲ FL-04900
			MATTE	770351 ▲ FL-02100	
		ORIGINES BLANC	GLOSSY	770357 ▲ FL-02200	770349 ▲ FL-04900
			MATTE	770353 ▲ FL-02100	
		ORIGINES OMBRE DORÉE	GLOSSY	770356 ▲ FL-02200	770348 ▲ FL-04900
			MATTE	770352 ▲ FL-02100	

PEZZI SPECIALI/SPECIAL TRIMS/PIÈCES SPÉCIALES/FORMSTÜCKE/PIEZAS ESPECIALES/Специальные изделия







10 mm 3/8" ↑↓		COLOR	SURFACE	4,6x60 1 ^{4/5"} x23 ^{5/8"} battiscopa	33x120x3 13"x47 ^{1/4"} x1 ^{1/8"} gradino pz/box 2
LES ORIGINES DE REX		ORIGINES OR	GLOSSY	770366 ◆ FL-01600	770374 ▲ FL-22600
			MATTE	770362 ◆ FL-01600	770370 ▲ FL-20400
		ORIGINES ARGENT	GLOSSY	770363 ◆ FL-01600	770371 ▲ FL-22600
			MATTE	770359 ◆ FL-01600	770367 ▲ FL-20400
		ORIGINES BLANC	GLOSSY	770365 ◆ FL-01600	770373 ▲ FL-22600
			MATTE	770361 ◆ FL-01600	770369 ▲ FL-20400
		ORIGINES OMBRE DORÉE	GLOSSY	770364 ◆ FL-01600	770372 ▲ FL-22600
			MATTE	770360 ◆ FL-01600	770368 ▲ FL-20400

Per un effetto ottimale della posa, florim suggerisce di mantenere 2 mm di fuga per pose monofornate e 3 mm per combinare formati misti - For optimal installation results, florim recommends maintaining a joint of 2 mm 1/12" for single format installations and 3 mm 1/8" to combine mixed formats. - Pour réaliser une pose parfaite, florim suggère de maintenir 2 mm de joint pour la pose des monofornats, et 3 mm pour les combinaisons de formats mixtes. - Um einen optimalen effekt beim verlegen zu erzielen empfiehlt florim eine 2 mm fuge bei einformatigen verlegungen und 3 mm fuge bei formatkombinationen Para lograr los máximos resultados en la posa del producto, florim aconseja 2 mm de junta en aplicaciones monofornato y 3 mm en combinaciones de formatos mixtos - ДЛЯ ОПТИМАЛЬНОЙ УКЛАДКИ - FLORIM РЕКОМЕНДУЕТ ВЫДЕРЖИВАТЬ ЗАЗОР 2 ММ ДЛЯ МОНОФОРМАТНОЙ И 3 ММ ПРИ СМЕШАННЫХ ФОРМАТАХ.





In relazione alle differenti tecnologie produttive l'accostamento di prodotti con spessori diversi potrebbe presentare delle disomogeneità, se ne consiglia pertanto l'abbinamento. / Due to the different production technologies, contiguous installation of products with different thickness may give a non-homogeneous result. For this reason we do not recommend this option. / Vu que différentes technologies de production sont utilisées avec des épaisseurs différentes, des problèmes d'homogénéité pourraient se présenter, il est donc déconseillé de les poser ensemble. / Wegen unterschiedlicher Produktionstechnologien können die Fliesen mit verschiedenen Materialstärken optische Differenzen aufweisen. Von einem direkten Aneinanderlegen wird deshalb abgeraten. / Dadas las diferentes tecnologías productivas, la combinación de productos de diferentes espesores podría dar lugar a heterogeneidad, por lo que se desaconseja mezclarlas. / В связи с различием в технологиях производства, сочетание продукции разной толщины иногда может представлять неоднородность материала. Такие сочетания следует избегать.

LES ORIGINES DE REX	scatola - box			pallet		
	pz	mq	kg	box	mq	kg
80x180	2	2,88	67,20	20	57,60	1400
60x120	2	1,44	31,70	30	43,20	980
60x60	3	1,08	23,80	40	43,20	980
30x60	6	1,08	24,10	40	43,20	990

LES ORIGINES DE REX	scatola - box			pallet		
	pz	ml	kg	box	mq	kg
4,6x60 battiscopa	14	8,40	8,40	-	-	-

6 mm 1/4" ↑ ↓				30x30 $1\frac{1}{4}'' \times 1\frac{1}{4}''$  mosaico tessere 7,5x7,5 pz/box 11	30x30 $1\frac{1}{4}'' \times 1\frac{1}{4}''$  muretto tessere 7,5x15 pz/box 11
		COLOR	SURFACE		
LES ORIGINES DE REX		ORIGINES OR	GLOSSY	770390 ▲ FL-02100	770382 ▲ FL-02100
			MATTE	770386 ▲ FL-01800	770378 ▲ FL-01800
		ORIGINES ARGENT	GLOSSY	770387 ▲ FL-02100	770379 ▲ FL-02100
			MATTE	770383 ▲ FL-01800	770375 ▲ FL-01800
		ORIGINES BLANC	GLOSSY	770389 ▲ FL-02100	770381 ▲ FL-02100
			MATTE	770385 ▲ FL-01800	770377 ▲ FL-01800
		ORIGINES OMBRE DORÉE	GLOSSY	770388 ▲ FL-02100	770380 ▲ FL-02100
			MATTE	770384 ▲ FL-01800	770376 ▲ FL-01800

PEZZI SPECIALI/SPECIAL TRIMS/PIÈCES SPÉCIALES/FORMSTÜCKE/PIEZAS ESPECIALES/Специальные изделия

6 mm 1/4" ↑ ↓				4,6x60 $1\frac{4}{5}'' \times 2\frac{3}{8}''$  battiscopa
		COLOR	SURFACE	
LES ORIGINES DE REX		ORIGINES OR	GLOSSY	770398 ◆ FL-01800
			MATTE	770394 ◆ FL-01800
		ORIGINES ARGENT	GLOSSY	770395 ◆ FL-01800
			MATTE	770391 ◆ FL-01800
		ORIGINES BLANC	GLOSSY	770397 ◆ FL-01800
			MATTE	770393 ◆ FL-01800
		ORIGINES OMBRE DORÉE	GLOSSY	770396 ◆ FL-01800
			MATTE	770392 ◆ FL-01800



MATIÈRES DE REX

gres fine porcellanato
fine porcelain stoneware
grès cérame fin
feinsteinzeug-kollektionen
gres porcelánico fino
фарфоровый керамогранит





MATIÈRES DE REX

La sensazione di autenticità e il particolare feeling delle superfici nate dalla lavorazione manuale della materia sono la caratteristica fondamentale di **Matières de Rex**. Un attento e appassionato lavoro di perfezionamento ha definito lo sviluppo morbido e differenziato delle sfumature di colore, che nelle ampie superfici mostra una eleganza unica ed un equilibrio estetico che fa la differenza, aumentando la versatilità stilistica della collezione. **Matières de Rex** è una superficie perfetta per ambienti contemporanei e di tendenza, ma ha tutta la classe per vestire anche spazi eleganti e sobri. La palette cromatica offre sei toni moderni e originali, che possono creare interessanti combinazioni.

The authentic, special feeling of handworked surfaces is the key feature of **Matières de Rex**. A perfectionist attention to detail has resulted in soft, differentiated colour nuances which, on these large surfaces, yields an aesthetic equilibrium which stands out from the crowd and augments the stylistic versatility of the collection. **Matières de Rex** is the perfect solution for modern, fashionable settings, with all the class of elegant, sober designs. The colour palette consists of six modern, original tonalities, ideal for combining in unique patterns.

La sensation d'authenticité et l'aspect particulier des surfaces issues du traitement manuel de la matière sont les caractéristiques fondamentales de **Matières de Rex**. Un travail de perfectionnement attentif et passionné a permis de développer des nuances de couleur souples et différenciées, d'où transparaît sur les grandes surfaces une élégance unique et un équilibre esthétique qui fait la différence, au bénéfice d'une polyvalence stylistique accrue. **Matières de Rex** est parfaitement adaptée aux espaces contemporains et tendance, mais peut également habiller des espaces élégants et sobres. La palette chromatique propose six tons modernes et originaux qui peuvent être utilisés pour créer d'intéressantes combinaisons.

Das Gefühl der Authentizität und die besondere Empfindung der durch die manuelle Bearbeitung der Materie entstandenen Oberflächen sind die wesentliche Charakteristik von **Matières de Rex**. Eine sorgfältige und begeisterte Arbeit der Feinabstimmung, die den weichen und differenzierten Verlauf der Farbtöne definierte, der auf den großen Flächen eine einzigartige Eleganz und ästhetische Balance aufweist, die entscheidend sind, und die stilistische Vielseitigkeit der Kollektion erhöhen. **Matières de Rex** ist eine perfekte Oberfläche für ein modernes und zeitgemäßes Ambiente, jedoch auch mit dem Stil für elegante und schlichte Räumlichkeiten. Die Farbpalette weist sechs moderne und originelle Farbtöne auf, die spannende Kombinationen schaffen können.

La sensación de autenticidad y el tacto especial de las superficies nacidas de la elaboración manual de la materia son la característica fundamental de **Matières de Rex**. Un atento y apasionado trabajo de perfeccionamiento ha definido el desarrollo suave y diferenciado de los matices de color, que en las amplias superficies muestra una elegancia única y un equilibrio estético que marca la diferencia, aumentando la versatilidad estilística de la colección. **Matières de Rex** es una superficie perfecta para ambientes contemporáneos y de tendencia, pero tiene toda la clase para vestir también espacios elegantes y sobrios. La paleta cromática ofrece seis tonos modernos y originales que pueden crear combinaciones interesantes.

Переплетение традиций и инноваций для создания привлекательной поверхности. Ощущение аутентичности и особенное чувство поверхности, порожденные ручной обработкой материала, являются краеугольной характеристикой **Matières de Rex**. Внимательная и увлеченная работа по совершенству привела к плавной и дифференцированной разработке оттенков цвета, которые на больших поверхностях обнаруживают уникальную элегантность и выдающееся эстетическое равновесие, повышая стилистическую универсальность коллекции. **Matières de Rex** - это великолепный материал для современных интерьеров, соответствующих последним тенденциям, но он обладает всем необходимым классом также для отделки элегантных и строгих пространств. Палитра цветов предлагает шесть современных и оригинальных тонов, которые могут создавать интересные сочетания. актуальным стилистическим сочетаниям проявляется романтическое очарование камня.

MATIÈRES DE REX

MATIÈRES SABLE



MATIÈRES MOU



R10
(matte)
CLASSE A+B

R11
(strutturato)
CLASSE
A+B+C

DCOF>
0,42 Wet

10 mm 3/8" ↑↓

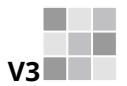

R9
(matte)
CLASSE A

R10
(R+PTV)
CLASSE
A+B
PTV>36 wet
slider 4S

DCOF>
0,42 Wet

6 mm 1/4" ↑↓

FLOORM OVERSIZE
magnUlm

GRES FINE PORCELLANATO

FINE PORCELAIN STONEWARE/GRES CERAME FIN/FEINSTEINZEUG-KOLLEKTIONEN/GRES PORCELANICO FINO/ФАРФОРОВЫЙ КЕРАМОГРАНИТ

SQUADRATO - SQUARED - EQUARRI - REKTIFIZIERT - ESCUADRADO - КАЛИБРОВАННАЯ

				10 mm 3/8" ↑↓		80x80 31 1/2" x 31 1/2"		40x80 15 3/4" x 31 1/2"		60x120 23 5/8" x 47 1/4"		60x60 23 5/8" x 23 5/8"		30x60 11 4/5" x 23 5/8"	
		COLOR	SURFACE												
MATIÈRES DE REX		MATIÈRES SABLE	MATTE	755705 ■ FL-09300	755711 ■ FL-07000	755717 ■ FL-10300	755724 ■ FL-07000	755730 ■ FL-06200							
			STRUTTURATO	-	755736 ■ FL-07000	-	-	-							
		MATIÈRES MOU	MATTE	755706 ■ FL-09300	755712 ■ FL-07000	755719 ■ FL-10300	755725 ■ FL-07000	755731 ■ FL-06200							
			STRUTTURATO	-	755737 ■ FL-07000	-	-	-							

				6 mm 1/4" ↑↓		120x280 47 1/4" x 110 1/4"		120x240 47 1/4" x 94 1/2"		120x120 47 1/4" x 47 1/4"		60x120 23 5/8" x 47 1/4"	
		COLOR	SURFACE										
MATIÈRES DE REX		MATIÈRES SABLE	MATTE	757641 ■ FL-12400	756119 ■ FL-11300	756123 ■ FL-09700	756127 ■ FL-09100						
			R+PTV	-	758811 ■ FL-11300	757645 ■ FL-09700	-						
		MATIÈRES MOU	MATTE	757644 ■ FL-12400	756122 ■ FL-11300	756126 ■ FL-09700	756130 ■ FL-09100						
			R+PTV	-	758814 ■ FL-11300	757648 ■ FL-09700	-						

MATIÈRES NUAGE



MATIÈRES GRIS



R10
(matte)
CLASSE A+B

R11
(strutturato)
CLASSE
A+B+C

DCOF>
0,42 Wet

10 mm 3/8" ↑↓



R9
(matte)
CLASSE A

R10
(R+PTV)
CLASSE
A+B
PTV>36 wet
slider 4S

DCOF>
0,42 Wet

6 mm 1/4" ↑↓

FLORIM OVERSIZE
magnUlm

GRES FINE PORCELLANATO

FINE PORCELAIN STONEWARE/GRES CERAME FIN/FEINSTEINZEUG-KOLLEKTIONEN/GRES PORCELANICO FINO/ФАРФОРОВЫЙ КЕРАМОГРАНИТ

SQUADRATO - SQUARED - EQUARRI - REKTIFIZIERT - ESCUADRADO - КАЛИБРОВАННАЯ

				10 mm 3/8" ↑↓		80x80 31 1/2"x31 1/2"		40x80 15 3/4"x31 1/2"		60x120 23 5/8"x47 1/4"		60x60 23 5/8"x23 5/8"		30x60 11 5/8"x23 5/8"	
		COLOR	SURFACE												
MATIÈRES DE REX		MATIÈRES NUAGE	MATTE	755708 ■ FL-09300	755714 ■ FL-07000	755721 ■ FL-10300	755727 ■ FL-07000	755733 ■ FL-06200							
			STRUTTURATO	-	755739 ■ FL-07000	-	-	-							
		MATIÈRES GRIS	MATTE	755707 ■ FL-09300	755713 ■ FL-07000	755720 ■ FL-10300	755726 ■ FL-07000	755732 ■ FL-06200							
			STRUTTURATO	-	755738 ■ FL-07000	-	-	-							

				6 mm 1/4" ↑↓		120x280 47 1/4"x110 1/4"		120x240 47 1/4"x94 1/2"		120x120 47 1/4"x47 1/4"		60x120 23 5/8"x47 1/4"	
		COLOR	SURFACE										
MATIÈRES DE REX		MATIÈRES NUAGE	MATTE	757642 ■ FL-12400	756120 ■ FL-11300	756124 ■ FL-09700	756128 ■ FL-09100						
			R+PTV	-	758812 ■ FL-11300	757646 ■ FL-09700	-						
		MATIÈRES GRIS	MATTE	757643 ■ FL-12400	756121 ■ FL-11300	756125 ■ FL-09700	756129 ■ FL-09100						
			R+PTV	-	758813 ■ FL-11300	757647 ■ FL-09700	-						

MATIÈRES DE REX

MATIÈRES BRUN



MATIÈRES BARRIQUE

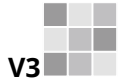

R10
(matte)
CLASSE A+B

R11
(strutturato)
CLASSE
A+B+C



DCOF>
0,42 Wet

10 mm 3/8" ↑↓

GRES FINE PORCELLANATO

FINE PORCELAIN STONEWARE/GRES CERAME FIN/FEINSTEINZEUG-KOLLEKTIONEN/GRES PORCELANICO FINO/ФАРФОРОВЫЙ КЕРАМОГРАНИТ

SQUADRATO - SQUARED - EQUARRI - REKTIFIZIERT - ESCUADRADO - КАЛИБРОВАННАЯ

				80x80 31 ^{1/2} "x31 ^{1/2} "	40x80 15 ^{3/4} "x31 ^{1/2} "	60x120 23 ^{5/8} "x47 ^{1/4} "	60x60 23 ^{5/8} "x23 ^{5/8} "	30x60 11 ^{1/5} "x23 ^{5/8} "
MATIÈRES DE REX		MATIÈRES BRUN	MATTE	755709 ■ FL-09300	755715 ■ FL-07000	755722 ■ FL-10300	755728 ■ FL-07000	755734 ■ FL-06200
			STRUTTURATO	-	755740 ■ FL-07000	-	-	-
		MATIÈRES BARRIQUE	MATTE	755710 ■ FL-09300	755716 ■ FL-07000	755723 ■ FL-10300	755729 ■ FL-07000	755735 ■ FL-06200
			STRUTTURATO	-	755741 ■ FL-07000	-	-	-

MATIÈRES SABLE



MATIÈRES NUAGE



R11
(strutturato)
CLASSE
A+B+C

DCOF >
0,42 Wet

20 mm 3/4" ↑↓

MATIÈRES GRIS



MATIÈRES MOU



GRES FINE PORCELLANATO

FINE PORCELAIN STONWARE/GRES CERAME FIN/FEINSTEINZEUG-KOLLEKTIONEN/GRES PORCELANICO FINO/ФАРФОРОВЫЙ КЕРАМОГРАНИТ

20 mm 3/4" ↑↓		COLOR	SURFACE	20,2x20,2 8"x8"	20,2x30,4 8"x12"
MATIÈRES DE REX		MATIÈRES SABLE	STRUTTURATO	755742 ■ FL-10800	755748 ■ FL-10800
		MATIÈRES NUAGE	STRUTTURATO	755745 ■ FL-10800	755751 ■ FL-10800
		MATIÈRES GRIS	STRUTTURATO	755744 ■ FL-10800	755750 ■ FL-10800
		MATIÈRES MOU	STRUTTURATO	755743 ■ FL-10800	755749 ■ FL-10800

	RESISTENZA ALLA FLESSIONE IN N/mm ² N/mm ² FLEXURAL STRENGTH TEST / RESISTANCE A LA FLEXION EN N/mm ² / BIEGEFESTIGKEIT IN N/mm ² / RESISTENCIA A LA FLEXION EN N/mm ² / УСТОЙЧИВОСТЬ К ИЗГИБУ В Н/мм ²	valore medio 52 N/mm ²
	Forza di rottura in N (sp. > 7,5 mm) Breaking strength in N (thickness > 7,5 mm) / Force de rupture en N (ép. > 7,5 mm) / Bruchlast in N (Dicke > 7,5 mm) / Fuerza de rotura en N (g. > 7,5 mm) / Разрушающее усилие, Н (толщ. > 7,5 мм)	valore medio 14000 N

MATIÈRES DE REX	scatola - box			pallet		
	pz	mq	kg	box	mq	kg
20,2x20,2 20mm	12	0,49	22,00	54	26,46	1210
20,2x30,4 20mm	7	0,43	19,20	60	25,80	1880

MATIÈRES DE REX OUTDOOR

Vantaggi tecnici - Technical advantages - Avantages techniques Technische Vorteile - Ventajas técnicas - Технические преимущества

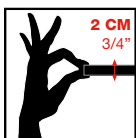

- Lastra monolitica compatta di spessore 2 cm squadrata e rettificata
- Compact monolithic slab 2 cm thick squared and rectified
- Dalle monolithique compacte de 2 cm d'épaisseur, équaree et rectifiée
- Kompakte monolithische Platte, 2 cm dick, rechteckig und scharfkantig geschliffen
- Losa monolítica compacta de 2 cm de espesor, escuadrada y rectificada.
- Монолитная плотная плита толщиной 2 см, с обрезанными и выровненными кромками

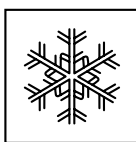

- INGELIVO
- FROST RESISTANT
- INGÉLIF
- FROSTBESTÄNDIG
- RESISTENTE A LA HELADA
- МОРОЗОСТОЙКАЯ

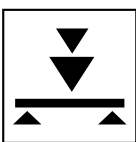

- ELEVATA RESISTENZA AI CARICHI STATICI
- HIGH STATIC LOAD RESISTANCE
- RÉSISTANCE ÉLEVÉE AUX CHARGES STATIQUES
- HOHE STATISCHE BELASTBARKEIT
- ELEVADA RESISTENCIA A LAS CARGAS ESTÁTICAS
- ВЫДЕРЖИВАЕТ БОЛЬШИЕ СТАТИЧЕСКИЕ НАГРУЗКИ

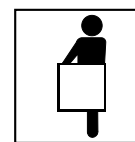

- FACILE DA POSARE
- EASY TO INSTALL
- FACILE À POSER
- VERLEGELEICHT
- FÁCIL DE COLOCAR
- ЛЕГКО УКЛАДЫВАЕТСЯ



- ANTISCIVOLO R11
- ANTI SLIP R11
- ANTIDÉRAPANT R11
- RUTSCHFEST R11
- ANTIDESLIZANTE R11
- НЕСКОЛЬЗКАЯ - R11

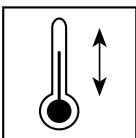

- RESISTENTE AGLI SBALZI TERMICI
- THERMAL SHOCK RESISTANT
- RÉSISTANT AUX ÉCARTS THERMIQUES
- TEMPERATURWECHSELBESTÄNDIG
- RESISTENTE A LAS OSCILACIONES TÉRMICAS
- СТОЙКАЯ К ТЕПЛОВЫМ ПЕРЕПАДАМ



- FACILE DA PULIRE
- EASY TO CLEAN
- FACILE À NETTOYER
- REINIGUNGSLEICHT
- FÁCIL DE LIMPIAR
- ЛЕГКО ЧИСТИТСЯ

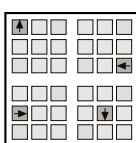

- RIMOVIBILE E RIUTILIZZABILE
- REMOVABLE AND REUSABLE
- DÉMONTABLE ET RÉUTILISABLE
- ENTFERNBAR UND WIEDERVERWENDBAR
- DESMONTABLE Y REUTILIZABLE
- МОЖЕТ СНИМАТЬСЯ И ПОВТОРНО ИСПОЛЬЗОВАТЬСЯ



- INATTACCABILE DA AGENTI CHIMICI E MUFFE
- IMPERVIOUS TO ATTACK BY CHEMICALS OR MOULD
- RÉSISTANT AUX AGENTS CHIMIQUES ET AUX MOISSISSURES
- UNANGREIFBAR DURCH CHEMISCHE STOFFE UND SCHIMMEL
- RESISTENTE A LOS AGENTES QUÍMICOS Y A LOS MOHOS
- НЕ ПОДВЕРГАЕТСЯ ВОЗДЕЙСТВИЮ ХИМИЧЕСКИХ ВЕЩЕСТВ И ПЛЕСЕНИ

Applicazioni - Applications - Applications - Verlegung - Aplicaciones - Применения

- Posa diretta su erba
- Direct installation on grass
- Pose direct sur de l'herbe
- Verlegung direkt auf Rasen
- Colocación directa sobre hierba
- Прямая укладка на траву

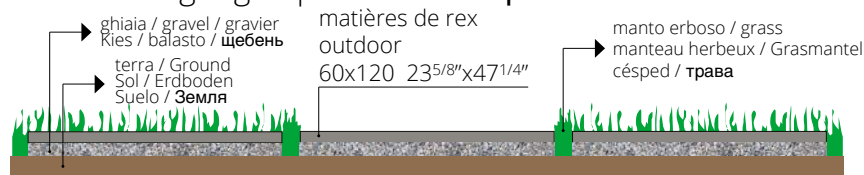

- Posa diretta su ghiaia
- Direct installation over gravel
- Pose direct sur du gravier
- Verlegung direkt auf Kies
- Colocación directa sobre grava
- Прямая укладка на гальку

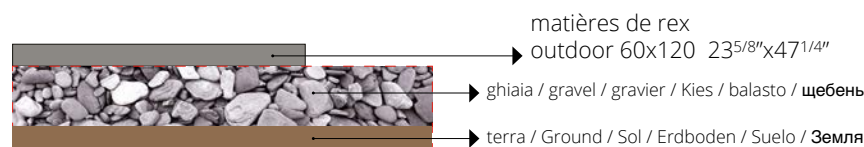

- Posa su massetto cementizio
- Installation on sand-cement screed
- Pose sur chape ciment
- Verlegung auf Zement-Unterbetonblock
- Colocación sobre contrapiso de hormigón
- Укладка на цементную стяжку

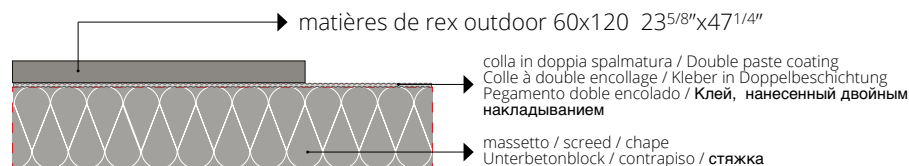

- Posa su piedini fissi o regolabili
- Installation on fixed or adjustable feet
- Pose sur pieds fixes ou réglables
- Verlegung auf feststehende oder regulierbare FüÙe
- Colocación sobre pies fijos o regulables
- Укладка на фиксированных или регулируемых ножках

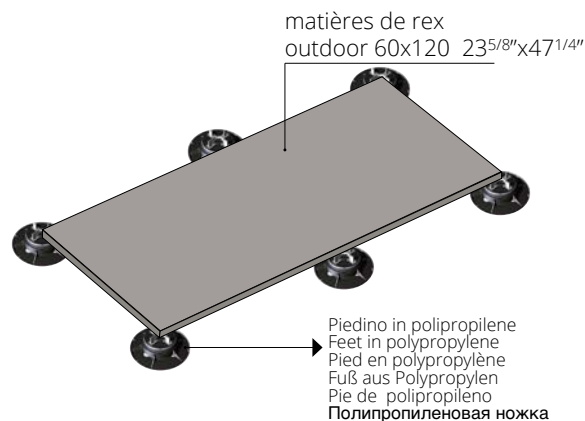

Per le specifiche di utilizzo dei sistemi sopraelevati vedi il sito florim.com
For the specifics on use of raised systems visit the site florim.com
Pour les caractéristiques d'utilisation des systèmes surélevés, voir le site florim.com
Für die Nutzungsbedingungen der Doppelbodensysteme siehe Webseite florim.com
Para las especificaciones de empleo de los sistemas sobreelevados consulte el sitio web florim.com
Технические характеристики систем фальшполов см. на сайте florim.com

Le lastre ceramiche sono sottoposte a un trattamento di compattazione termica che assicura resistenza e durata nel tempo. Il bassissimo assorbimento d'acqua rende perciò il materiale ingelivo. Ciò può comportare ristagni d'acqua superficiali anche per materiale installato a regola d'arte. / Ceramic tiles undergo a compacting thermal treatment that ensures resistance and durability. The low level of water absorption makes the slabs frost resistant. This could result in superficial water stagnations even if materials are installed in a workmanlike manner. / Les carreaux de céramique subissent un traitement thermique de compactage qui assure résistance et durabilité. Le bas niveau d'absorption d'eau rend les dalles résistant au gel. Il pourrait en résulter des stagnations d'eau superficielles, même si les dalles ont été installées dans les règles de l'art. / Die Keramikplatten werden einer thermischen Verdichtung unterzogen, welche die Widerstandsfähigkeit und Langlebigkeit sichert. Die extrem niedrige Wasseraufnahme macht das Material frostsicher. Die hohe Materialdichte kann, auch bei einer perfekten Verlegung, eine längere Abtrocknungszeit von angestauntem Wasser zur Folge haben. / Las baldosas cerámicas se someten a un tratamiento de compactación térmica que asegura resistencia y durabilidad. La baja absorción de agua hace que las baldosas resistan al hielo. Esto podría resultar en estancamientos superficiales de agua, incluso si los materiales están instalados según las reglas del arte. / Керамическая плитка подвергается термическому уплотнению, что обеспечивает ей прочность и износостойкость. За счёт очень низкого водопоглощения она не промерзает, при этом даже при правильной укладке возможны застои воды на поверхности плитки.

MATIÈRES SABLE



MATIÈRES NUAGE



R11
(strutturato)
CLASSE
A+B+C

DCOF >
0,42 Wet

20 mm 3/4" ↑↓

MATIÈRES BRUN



GRES FINE PORCELLANATO

FINE PORCELAIN STONWARE/GRES CERAME FIN/FEINSTEINZEUG-KOLLEKTIONEN/GRES PORCELANICO FINO/ФАРФОРОВЫЙ КЕРАМОГРАНИТ
SQUADRATO - SQUARED - EQUARRI - REKTIFIZIERT - ESCUADRADO - КАЛИБРОВАННАЯ

20 mm 3/4" ↑↓

	COLOR	SURFACE	60x120 23 ^{5/8"} x47 ^{1/4"}
MATIÈRES DE REX	MATIÈRES SABLE	STRUTTURATO	768518 ■ FL-11300
	MATIÈRES NUAGE	STRUTTURATO	768517 ■ FL-11300
	MATIÈRES BRUN	STRUTTURATO	768516 ■ FL-11300



Recycled material content certification







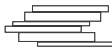

ISO 10545-4	RESISTENZA ALLA FLESSIONE IN N/mm ² N/mm ² FLEXURAL STRENGTH TEST / RESISTANCE A LA FLEXION EN N/mm ² / BIEGEFESTIGKEIT IN N/mm ² / RESISTENCIA A LA FLEXION EN N/mm ² / УСТОЙЧИВОСТЬ К ИЗГИБУ В Н/мм ²	valore medio 52 N/mm ²
	Forza di rottura in N (sp. > 7,5 mm) Breaking strength in N (thickness > 7,5 mm) / Force de rupture en N (ép. > 7,5 mm) / Bruchlast in N (Dicke > 7,5 mm) / Fuerza de rotura en N (g. > 7,5 mm) / Разрушающее усилие, Н (толщ. > 7,5 мм)	valore medio 14000 N

PEZZI SPECIALI









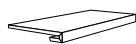

Special trims/Pièces spéciales/Formstücke
Piezas especiales/СПЕЦИАЛЬНЫЕ ИЗДЕЛИЯ
pag 188/193

MATIÈRES DE REX	scatola - box			pallet		
	pz	mq	kg	box	mq	kg
60x120 20mm	1	0,72	32,30	30	21,60	990

MATIÈRES DE REX





10 mm 3/8" ↑↓		COLOR	SURFACE	30x30 11 ^{4/5"} x11 ^{4/5"}  mosaico tessere 5x5 pz/box 11	21x40 8 ^{1/4"} x15 ^{3/4"}  modulo listello sfalsato pz/box 5	30x30 11 ^{4/5"} x11 ^{4/5"}  modulo muretto 3D pz/box 6
MATIÈRES DE REX		MATIÈRES SABLE	MATTE	755930 ▲ FL-01500	755936 ▲ FL-01900	755942 ▲ FL-03600
		MATIÈRES MOU	MATTE	755931 ▲ FL-01500	755937 ▲ FL-01900	755943 ▲ FL-03600
		MATIÈRES NUAGE	MATTE	755933 ▲ FL-01500	755939 ▲ FL-01900	755945 ▲ FL-03600
		MATIÈRES GRIS	MATTE	755932 ▲ FL-01500	755938 ▲ FL-01900	755944 ▲ FL-03600
		MATIÈRES BRUN	MATTE	755934 ▲ FL-01500	755940 ▲ FL-01900	755946 ▲ FL-03600
		MATIÈRES BARRIQUE	MATTE	755935 ▲ FL-01500	755941 ▲ FL-01900	755947 ▲ FL-03600

PEZZI SPECIALI/SPECIAL TRIMS/PIÈCES SPÉCIALES/FORMSTÜCKE/PIEZAS ESPECIALES/Специальные изделия





10 mm 3/8" ↑↓		COLOR	SURFACE	4,6x60 1 ^{4/5"} x23 ^{5/8"}  battiscopa	15x30x4 6"x11 ^{4/5"} x1 ^{4/7"}  elemento elle strutturato pz/box 6	33x120x3 13"x47 ^{1/4"} x1 ^{1/8"}  gradino pz/box 2	33x120x3 13"x47 ^{1/4"} x1 ^{1/8"}  angolo gradino dx pz/box 2	33x120x3 13"x47 ^{1/4"} x1 ^{1/8"}  angolo gradino sx pz/box 2
MATIÈRES DE REX		MATIÈRES SABLE	MATTE	755948 ◆ FL-01600	755954 ▲ FL-02400	755960 ▲ FL-20400	755966 ▲ FL-31100	755972 ▲ FL-31100
		MATIÈRES MOU	MATTE	755949 ◆ FL-01600	755955 ▲ FL-02400	755961 ▲ FL-20400	755967 ▲ FL-31100	755973 ▲ FL-31100
		MATIÈRES NUAGE	MATTE	755951 ◆ FL-01600	755957 ▲ FL-02400	755963 ▲ FL-20400	755969 ▲ FL-31100	755975 ▲ FL-31100
		MATIÈRES GRIS	MATTE	755950 ◆ FL-01600	755956 ▲ FL-02400	755962 ▲ FL-20400	755968 ▲ FL-31100	755974 ▲ FL-31100
		MATIÈRES BRUN	MATTE	755952 ◆ FL-01600	755958 ▲ FL-02400	755964 ▲ FL-20400	755970 ▲ FL-31100	755976 ▲ FL-31100
		MATIÈRES BARRIQUE	MATTE	755953 ◆ FL-01600	755959 ▲ FL-02400	755965 ▲ FL-20400	755971 ▲ FL-31100	755977 ▲ FL-31100

MATIÈRES DE REX	scatola - box			pallet		
	pz	m ²	kg	box	m ²	kg
80x80	2	1,28	29,80	40	51,20	1220
40x80	3	0,96	22,00	56	53,76	1260
60x120	2	1,44	31,80	30	43,20	980
60x60	3	1,08	24,20	40	43,20	990
30x60	6	1,08	24,10	40	43,20	990

MATIÈRES DE REX	scatola - box			pallet		
	pz	ml	kg	box	m ²	kg
4,6x60 battiscopa	14	8,40	8,40	-	-	-

6 mm 1/4" ↑↓				30x30 11 ^{4/5"} x11 ^{4/5"}	30x30 11 ^{4/5"} x11 ^{4/5"}	30x30 11 ^{4/5"} x11 ^{4/5"}
	COLOR	SURFACE		mosaico tessere 7,5x7,5 pz/box 11	muretto tessere 7,5x15 pz/box 11	mosaico tessere 1,5x3 pz/box 11
MATIÈRES DE REX		MATIÈRES SABLE	MATTE	755978 ▲ FL-01800	755984 ▲ FL-01800	755990 ▲ FL-02700
		MATIÈRES MOU	MATTE	755979 ▲ FL-01800	755985 ▲ FL-01800	755991 ▲ FL-02700
		MATIÈRES NUAGE	MATTE	755981 ▲ FL-01800	755987 ▲ FL-01800	755993 ▲ FL-02700
		MATIÈRES GRIS	MATTE	755980 ▲ FL-01800	755986 ▲ FL-01800	755992 ▲ FL-02700

PEZZI SPECIALI/SPECIAL TRIMS/PIÈCES SPÉCIALES/FORMSTÜCKE/PIEZAS ESPECIALES/Специальные изделия

6 mm 1/4" ↑↓				4,6x60 1 ^{4/5"} x23 ^{5/8"}
	COLOR	SURFACE		battiscopa
MATIÈRES DE REX		MATIÈRES SABLE	MATTE	755996 ◆ FL-01800
		MATIÈRES MOU	MATTE	755997 ◆ FL-01800
		MATIÈRES NUAGE	MATTE	755999 ◆ FL-01800
		MATIÈRES GRIS	MATTE	755998 ◆ FL-01800

Per un effetto ottimale della posa, florim suggerisce di mantenere 2 mm di fuga per pose monoformato e 3 mm per combinare formati misti - For optimal installation results, florim recommends maintaining a joint of 2 mm 1/12" for single format installations and 3 mm 1/8" to combine mixed formats. - Pour réaliser une pose parfaite, florim suggère de maintenir 2 mm de joint pour la pose des monoformats, et 3 mm pour les combinaisons de formats mixtes. - Um einen optimalen effekt beim verlegen zu erzielen empfiehlt florim eine 2 mm fugе bei einformatigen verlegungen und 3 mm fugе bei formatkombinationen Para lograr los máximos resultados en la posa del producto, florim aconseja 2 mm de junta en aplicaciones monoformato y 3 mm en combinaciones de formatos mixtos - **ДЛЯ ОПТИМАЛЬНОЙ УКЛАДКИ "FLORIM" РЕКОМЕНДУЕТ ВЫДЕРЖИВАТЬ ЗАЗОР 2 ММ ДЛЯ МОНОФОРМАТА И 3 ММ ПРИ СМЕШАННЫХ ФОРМАТАХ.**

In relazione alle differenti tecnologie produttive l'accostamento di prodotti con spessori diversi potrebbe presentare delle disomogeneità, se ne sconsiglia pertanto l'abbinamento. / Due to the different production technologies, contiguous installation of products with different thickness may give a non-homogeneous result. For this reason we do not recommend this option. / Vu que différentes technologies de production sont utilisées avec des épaisseurs différentes, des problèmes d'homogénéité pourraient se présenter, il est donc déconseillé de les poser ensemble. / Wegen unterschiedlicher Produktionstechnologien können die Fliesen mit verschiedenen Materialstärken optische Differenzen aufweisen. Von einem direkten Aneinanderlegen wird deshalb abgeraten. / Dadas las diferentes tecnologías productivas, la combinación de productos de diferentes espesores podría dar lugar a heterogeneidad, por lo que se desaconseja mezclarlas. / В связи с различием в технологиях производства, сочетание продукции разной толщины иногда может представлять неоднородность материала. Такие сочетания следует избегать.

FLORIM OVERSIZE
magnlum

120x280/120x240/120x120/60x120
Specifica Imballo pag.
Packaging specifications on page
Spécifications d'emballage à page
Verpackungsdetail Seite
Especificaciones de embalaje a la página
Информация об упаковке на стр.
200/201



PLANCHES DE REX

gres fine porcellanato
fine porcelain stoneware
grès cérame fin
feinsteinzeug-kollektionen
gres porcelánico fino
фарфоровый керамогранит





PLANCHES DE REX

Planches De Rex rappresenta lo stato dell'arte e fissa un nuovo punto di riferimento per il gres porcellanato ispirato alla estetica del legno, una tipologia tra le più apprezzate dal mercato. L'assortimento di formati è decisamente ai vertici, con doghe della misura ideale per spazi prestigiosi o raccolti; la gamma di colori originali e moderni è stata accuratamente studiata per intonarsi con materiali e nuances di tendenza nell'interior design contemporaneo. Ogni dettaglio della materia è definito con fedeltà e buon gusto, grazie alla sapienza dei tecnici Rex e ad impianti tecnologici d'avanguardia.

Planches De Rex sets a new benchmark for the porcelain tile interpretation of natural wood, currently one of the most prized types of ceramic. The collection has an unbeatable variety of formats, with slats of the ideal size for prestigious, discreet settings; its modern, original colours have been carefully selected to match the trends of contemporary interior design. Every detail is tasteful and faithful to the original material, thanks to Rex's know-how and cutting edge production technology.

Planches De Rex utilise les dernières technologies disponibles et représente une nouvelle référence pour le grès cérame inspiré de l'esthétique du bois, un type de produits parmi les plus appréciés du marché. L'assortiment de formats est conforme aux meilleurs standards et propose des lames de dimensions idéales pour des espaces prestigieux ou concentrés; la gamme de couleurs originales et modernes a été soigneusement étudiée pour s'adapter aux nuances et aux matériaux actuellement utilisés dans l'aménagement intérieur. Chaque détail de la matière est défini avec fidélité et style, grâce au savoir-faire des techniciens Rex et à des installations à la pointe de la technologie.

Planches De Rex repräsentiert den Stand der Technik und legt einen neuen Bezugspunkt für das Feinsteinzeug fest, inspiriert von der Ästhetik des Holzes, eine vom Markt am meisten geschätzte Typologie. Das Sortiment der Formate ist unverkennbar führend, mit Dauben in der idealen Größe für bedeutende oder ruhige Räumlichkeiten; das Spektrum von originellen und modernen Farben wurde sorgfältig durchdacht, um sich den modischen Materialien und Nuancen der zeitgemäßen Innenraumgestaltung anzupassen. Jedes Detail der Materie wurde, dank der Kenntnisse der Techniker von Rex und der fortschrittlichen technologischen Anlagen, mit Bedacht und Geschmack definiert.

Planches De Rex representa la vanguardia y fija un nuevo punto de referencia para el gres porcelánico inspirado en la estética de la madera, una tipología de las más apreciadas del mercado. La variedad de formatos destaca sin lugar a duda, con láminas de la medida ideal para espacios prestigiosos o recogidos; la gama de colores originales y modernos ha sido cuidadosamente estudiada para entonarse con materiales y tonos de tendencia dentro del diseño contemporáneo. Cada detalle de la materia se define con fidelidad y buen gusto gracias a la maestría de los técnicos Rex y a los sistemas tecnológicos de vanguardia.

Planches De Rex представляет собой образец совершенства и выступает в качестве нового ориентира для керамогранита, вдохновленного эстетикой дерева - наиболее ценимого рынком типа материала. Ассортимент форматов, безусловно, находится на высоте, предлагая рейки идеальных размеров для создания престижных и строгих пространств. Линейка оригинальных и современных цветов была тщательно проработана для сочетания с модными в современном дизайне интерьеров материалами и оттенками. Каждая деталь материала достоверно воспроизведена в хорошем вкусе благодаря мастерству специалистов Rex и современным технологическим системам синонимом элегантности.

PLANCHES DE REX

AMANDE



MIEL



V3

R10
(matte)

R11
(strutturato)

CLASSE
A+B
(matte/
strutturato)

DCOF >
0,42 Wet

10 mm 3/8" ↑↓

GRES FINE PORCELLANATO

FINE PORCELAIN STONEWARE/GRES CERAME FIN/FEINSTEINZEUG-KOLLEKTIONEN/GRES PORCELANICO FINO/ФАРФОРОВЫЙ КЕРАМОГРАНИТ

SQUADRATO - SQUARED - EQUARRI - REKTIFIZIERT - ESCUADRADO - КАЛИБРОВАННАЯ

			26,5x180 10 ^{3/8"} x70 ^{5/7"}	20x180 7 ^{7/8"} x70 ^{5/7"}	20x120 7 ^{7/8"} x47 ^{1/4"}	15x120 6"x47 ^{1/4"}	22,5x90 8 ^{5/7"} x35 ^{3/7"}	15x90 6"x35 ^{3/7"}
PLANCHES DE REX	AMANDE	MATTE	755693 ■ FL-09900	755698 ■ FL-09900	755608 ■ FL-07700	755666 ■ FL-07700	755682 ■ FL-06700	755677 ■ FL-06700
		STRUTTURATO	-	-	755671 ■ FL-07700	-	-	-
	MIEL	MATTE	755694 ■ FL-09900	755699 ■ FL-09900	755609 ■ FL-07700	755667 ■ FL-07700	755683 ■ FL-06700	755678 ■ FL-06700
		STRUTTURATO	-	-	755672 ■ FL-07700	-	-	-

NOISETTE

PERLE



V3
R10
 (matte)

R11
 (strutturato)

CLASSE
 A+B
 (matte/
 strutturato)



DCOF>
 0,42 Wet

10 mm 3/8" ↑↓

GRES FINE PORCELLANATO

FINE PORCELAIN STONEWARE/GRES CERAME FIN/FEINSTEINZEUG-KOLLEKTIONEN/GRES PORCELANICO FINO/ФАРФОРОВЫЙ КЕРАМОГРАНИТ

SQUADRATO - SQUARED - EQUARRI - REKTIFIZIERT - ESCUADRADO - КАЛИБРОВАННАЯ

10 mm 3/8" ↑↓		COLOR	SURFACE	26,5x180 10 ^{3/7"} x70 ^{5/7"}	20x180 7 ^{7/8"} x70 ^{5/7"}	20x120 7 ^{7/8"} x47 ^{1/4"}	15x120 6"x47 ^{1/4"}	22,5x90 8 ^{6/7"} x35 ^{3/7"}	15x90 6"x35 ^{3/7"}
PLANCHES DE REX		NOISETTE	MATTE	755696 ■ FL-09900	755702 ■ FL-09900	755611 ■ FL-07700	755669 ■ FL-07700	755685 ■ FL-06700	755680 ■ FL-06700
			STRUTTURATO	-	-	755674 ■ FL-07700	-	-	-
		PERLE	MATTE	755695 ■ FL-09900	755701 ■ FL-09900	755610 ■ FL-07700	755668 ■ FL-07700	755684 ■ FL-06700	755679 ■ FL-06700
			STRUTTURATO	-	-	755673 ■ FL-07700	-	-	-

PLANCHES DE REX

CHOCO



V3

R10
(matte)

R11
(strutturato)

CLASSE
A+B
(matte/
strutturato)

DCOF>
0,42 Wet

10 mm 3/8" ↑↓

GRES FINE PORCELLANATO

FINE PORCELAIN STONEWARE/GRES CERAME FIN/FEINSTEINZEUG-KOLLEKTIONEN/GRES PORCELANICO FINO/ФАРФОРОВЫЙ КЕРАМОГРАНИТ

SQUADRATO - SQUARED - EQUARRI - REKTIFIZIERT - ESCUADRADO - КАЛИБРОВАННАЯ

		10 mm 3/8" ↑↓			26,5x180 10 ^{3/8"} x70 ^{5/7"}	20x180 7 ^{7/8"} x70 ^{5/7"}	20x120 7 ^{7/8"} x47 ^{1/4"}	15x120 6"x47 ^{1/4"}	22,5x90 8 ^{5/7"} x35 ^{3/7"}	15x90 6"x35 ^{3/7"}
PLANCHES DE REX		CHOCO	COLOR	SURFACE	755697 ■ FL-09900	755703 ■ FL-09900	755612 ■ FL-07700	755670 ■ FL-07700	755686 ■ FL-06700	755681 ■ FL-06700
				MATTE						
				STRUTTURATO	-	-	755675 ■ FL-07700	-	-	-

10 mm 3/8" ↑ ↓

COLOR

SURFACE

80x80
31 1/2"x31 1/2"



D COR AMANDE

MATTE

755687
■ FL-10500



D COR MIEL

MATTE

755688
■ FL-10500

PLANCHES
DE REX



D COR NOISETTE

MATTE

755690
■ FL-10500



D COR PERLE

MATTE

755689
■ FL-10500



D COR CHOCO

MATTE

755691
■ FL-10500

PLANCHES DE REX

10 mm 3/8" ↑↓		COLOR	SURFACE	30x30 11 ^{4/5"} x11 ^{4/5"} modulo listello tessere 7,5x30 pz/box 6	15x45 6"x17 ^{5/8"} modulo listello sfalsato pz/box 6
PLANCHES DE REX		AMANDE	MATTE	756077 ▲ FL-01160	756082 ▲ FL-02300
		MIEL	MATTE	756078 ▲ FL-01160	756083 ▲ FL-02300
		NOISETTE	MATTE	756080 ▲ FL-01160	756085 ▲ FL-02300
		PERLE	MATTE	756079 ▲ FL-01160	756084 ▲ FL-02300
		CHOCO	MATTE	756081 ▲ FL-01160	756086 ▲ FL-02300

PEZZI SPECIALI/SPECIAL TRIMS/PIÈCES SPÉCIALES/FORMSTÜCKE/PIEZAS ESPECIALES/Специальные изделия

10 mm 3/8" ↑↓		COLOR	SURFACE	4,6x60 1 ^{4/5"} x23 ^{5/8"} battiscopa	15x30x4 6"x11 ^{4/5"} x1 ^{4/7"} elemento alle strutturato pz/box 4	40x120x3 15 ^{3/4"} x47 ^{1/4"} x1 ^{1/8"} gradino pz/box 2	40x120x3 15 ^{3/4"} x47 ^{1/4"} x1 ^{1/8"} angolo gradino DX pz/box 2	40x120x3 15 ^{3/4"} x47 ^{1/4"} x1 ^{1/8"} angolo gradino SX pz/box 2	40x120x3 15 ^{3/4"} x47 ^{1/4"} x1 ^{1/8"} angolo gradino DX/SX pz/box 1
PLANCHES DE REX		AMANDE	MATTE	756087 ◆ FL-01600	756092 ▲ FL-03600	756097 ▲ FL-21000	756102 ▲ FL-31100	756107 ▲ FL-31100	756112 ▲ FL-42900
		MIEL	MATTE	756088 ◆ FL-01600	756093 ▲ FL-03600	756098 ▲ FL-21000	756103 ▲ FL-31100	756108 ▲ FL-31100	756113 ▲ FL-42900
		NOISETTE	MATTE	756090 ◆ FL-01600	756095 ▲ FL-03600	756100 ▲ FL-21000	756105 ▲ FL-31100	756110 ▲ FL-31100	756115 ▲ FL-42900
		PERLE	MATTE	756089 ◆ FL-01600	756094 ▲ FL-03600	756099 ▲ FL-21000	756104 ▲ FL-31100	756109 ▲ FL-31100	756114 ▲ FL-42900
		CHOCO	MATTE	756091 ◆ FL-01600	756096 ▲ FL-03600	756101 ▲ FL-21000	756106 ▲ FL-31100	756111 ▲ FL-31100	756116 ▲ FL-42900

Nelle operazioni di posa a listoni sfalsati, si raccomanda sempre di fare in modo che il lato maggiore della piastrella termini a circa un terzo della lunghezza di quelle accanto (posa sfalsata "a 1/3"). - When installing staggered strips, we recommend that the tile's longer side should always end at about one-third of the length of the tiles next to it ("1/3" staggered installation) - Lors de la pose des listels décalés, il faut toujours faire en sorte que le côté le plus grand du carreau se trouve à environ 1/3 de la longueur des carreaux d'à côté (pose décalée "à 1/3"). - Beim Verlegen der Leisten in versetzter Form ist zu beachten, dass die höhere Seite der Fliese immer circa bei einem Drittel der Länge der sich daneben befindlichen Fliesen abschließt ("Um 1/3" versetzte Verlegung) - En las operaciones de colocación de listones escalonados, se recomienda hacerlo siempre de forma tal que el lado mayor del azulejo termine teniendo alrededor de un tercio de la longitud de los contiguos (colocación escalonada "a 1/3") - При укладке зигзагом следите за тем, чтобы более длинный край плиток заканчивался примерно на 1/3 длины соседних плиток (укладка зигзагом «1/3»)

Per un effetto ottimale della posa, florim suggerisce di mantenere 2 mm di fuga per pose monofornato e 3 mm per combinare formati misti - For optimal installation results, florim recommends maintaining a joint of 2 mm 1/12" for single format installations and 3 mm 1/8" to combine mixed formats. - Pour réaliser une pose parfaite, florim suggère de maintenir 2 mm de joint pour la pose des monofornats, et 3 mm pour les combinaisons de formats mixtes. - Um einen optimalen effekt beim verlegen zu erzielen empfiehlt florim eine 2 mm fugе bei einformatigen verlegungen und 3 mm fugе bei formatkombinationen Para lograr los máximos resultados en la posa del producto, florim aconseja 2 mm de junta en aplicaciones monofornato y 3 mm en combinaciones de formatos mixtos - **ДЛЯ ОПТИМАЛЬНОЙ УКЛАДКИ " FLORIM" РЕКОМЕНДУЕТ ВЫДЕРЖИВАТЬ ЗАЗОР 2 ММ ДЛЯ МОНОФОРМАТА И 3 ММ ПРИ СМЕШАННЫХ ФОРМАТАХ.**

PLANCHES DE REX	scatola - box			pallet		
	pz	mq	kg	box	mq	kg
26,5x180	3	1,44	33,60	42	60,48	1470
20x180	4	1,44	33,60	40	57,60	1400
20x120	6	1,44	31,40	24	34,56	780
15x120	6	1,08	24,10	32	34,56	800
22,5x90	6	1,22	27,20	54	65,61	1490
15x90	6	0,81	18,20	72	58,32	1330
PLANCHES DE REX	scatola - box			pallet		
	pz	ml	kg	box	mq	kg
4,6x60 battiscopa	14	8,40	8,40	-	-	-





PREXIOUS OF REX

gres porcellanato colorato in massa
coloured body porcelain stoneware
grès cérame colore dans la masse
durchgefärbte feinsteinzeug
gres porcelánico coloreado en masa
керамогранит, окращенный по всей тлщине





PREXIOUS OF REX

Simbolo di bellezza e indiscussa regina delle superfici, l'estetica del marmo trova inedite interpretazioni nella nuova collezione **Prexious of Rex**. Partendo dalla ricerca di esemplari lapidei rari e preziosi, i cromatismi e le venature sono stati rielaborati e reinterpretati con perizia tecnica e creatività, trasformandoli in creazioni originali di grande suggestione, che esprimono appieno il gusto inimitabile di Rex. Lo sviluppo armonioso del disegno che si rivela accostando le lastre in ampie superfici è un fattore di distinzione, così come le pregiate finiture di superficie, lucida e brillante o delicatamente satinata.

The pinnacle of elegance and undisputed queen of covering materials, marble is given new life in the **Prexious of Rex** collection. Starting from carefully selected, rare examples of marble, the colours and veining have been re-interpreted with all of Rex's technical skill and creativity, and transformed into highly evocative panels of inimitable elegance. The design was conceived to reveal harmonious patterns when the panels are placed next to each other over large surfaces, as do the textures, whether brilliant gloss or delicately satin-finished.

Incarnation de la beauté et reine incontestable des surfaces, l'esthétique du marbre est interprétée de manière inédite dans la nouvelle collection **Prexious of Rex**. À partir de la recherche de pierres rares et précieuses, les effets chromatiques et les marbrures, réélaborés et réinterprétés de manière créative avec un grand savoir-faire technique, ont été transformés en créations originales d'une grande beauté, qui expriment pleinement le style inimitable de Rex. Le développement harmonieux des motifs, qui se révèle en disposant les dalles côte à côte sur de grandes surfaces, est un facteur de distinction, à l'instar des belles finitions de surface, brillante ou délicatement satinée.

Symbol für Schönheit und unbestrittene Königin der Oberflächen findet die Ästhetik des Marmors ungewöhnliche Interpretationen in der neuen Kollektion **Prexious of Rex**. Ausgehend von der Suche nach seltenen und wertvollen Steinexemplaren, wurden die Chromatik und die Äderungen mit technischer Fachkenntnis und Kreativität neu verarbeitet und neu interpretiert und so in originelle Realisierungen von großem Charme verwandelt, die voll den unnachahmlichen Geschmack von Rex ausdrücken. Der harmonische Verlauf des Musters, der sich beim Zusammenfügen der Platten auf großen Flächen zeigt, stellt ein Unterscheidungsmerkmal dar, wie auch die wertvollen Oberflächenbearbeitungen: glänzend und brillant oder fein satiniert.

La estética del mármol, símbolo de belleza y reina indiscutible de las superficies, encuentra interpretaciones inéditas en la nueva colección **Prexious of Rex**. Partiendo de la búsqueda de ejemplares lapídeos raros y preciados, los cromatismos y las vetas han sido reelaborados y reinterpretados con habilidad técnica y creatividad, transformándolos en creaciones originales de gran sugestión que expresan por completo el gusto inimitable de Rex. El desarrollo armonioso del diseño que se revela combinando las losas en amplias superficies es un factor de distinción, así como los preciados acabados de la superficie, reluciente y brillante o delicadamente satinada.

Эстетика мрамора, символ красоты и неоспоримая королева поверхностей, по-новому интерпретируется в новой коллекции **Prexious of Rex**. Исходя из поиска редких и ценных пород камня, цвета и рисунок были технически совершенно и креативно проработаны и интерпретированы, превратив их в оригинальные и очень эффектные творения, полностью выражающие неподражаемый вкус Rex. Гармоничность рисунка, обнаруживающаяся при совмещении плит на больших поверхностях, является отличительной чертой, как и ценная отделка поверхностей - полированная и блестящая или же нежная сатиновая.

PREXIOUS OF REX

WHITE FANTASY



MOUNTAIN TREASURE

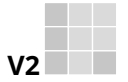

V2

DCOF>
0,42 Wet
(matte)

10 mm 3/8" ↑↓

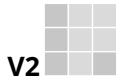

V2

DCOF>
0,42 Wet
(matte)

6 mm 1/4" ↑↓

FLORIM OVERSIZE
magnum

GRES PORCELLANATO COLORATO IN MASSA/COLOURED BODY PORCELAIN STONEWARE
GRÈS CÉRAMÉ COLORE DANS LA MASSE/DURCHGEFÄRBTE FEINSTEINZEUG/GRES PORCELÁNICO COLOREADO EN MASA/керамогранит, окрашенный по всей тлщине
SQUADRATO - SQUARED - EQUARRI - REKTIFIZIERT - ESCUADRADO - КАЛИБРОВАННАЯ

			10 mm 3/8" ↑↓		6 mm 1/4" ↑↓				
	COLOR	SURFACE	80x180 31 1/2" x 70 5/8"	80x80 31 1/2" x 31 1/2"	60x120 23 5/8" x 47 1/4"	30x120 11 4/5" x 47 1/4"	60x60 23 5/8" x 23 5/8"	30x60 11 4/5" x 23 5/8"	
PREXIOUS OF REX	WHITE FANTASY	GLOSSY	755815 ■ FL-11900	755827 ■ FL-10800	755843 ■ FL-11300	755855 ■ FL-12400	755867 ■ FL-09100	755880 ■ FL-07700	
		MATTE	755809 ■ FL-10500	755821 ■ FL-09300	755833 ■ FL-09900	755849 ■ FL-10800	755861 ■ FL-07300	755873 ■ FL-06200	
	MOUNTAIN TREASURE	GLOSSY	755816 ■ FL-11900	755828 ■ FL-10800	755844 ■ FL-11300	755856 ■ FL-12400	755868 ■ FL-09100	755881 ■ FL-07700	
		MATTE	755810 ■ FL-10500	755822 ■ FL-09300	755834 ■ FL-09900	755850 ■ FL-10800	755862 ■ FL-07300	755875 ■ FL-06200	
PREXIOUS OF REX	WHITE FANTASY	GLOSSY	756424 ■ FL-18800	757735 ■ FL-15100	756436 ■ FL-16100	756285 ■ FL-14000	756388 ■ FL-12400	756412 ■ FL-10300	756400 ■ FL-11300
		MATTE	756418 ■ FL-15600	757729 ■ FL-12400	756430 ■ FL-13400	756290 ■ FL-11300	756382 ■ FL-09700	756406 ■ FL-08400	756394 ■ FL-09100

PEARL ATTRACTION



DREAM ARABESQUE



DCOF>
0,42 Wet
(matte)





DCOF>
0,42 Wet
(matte)



FLORIM OVERSIZE
magnum

GRES PORCELLANATO COLORATO IN MASSA/COLOURED BODY PORCELAIN STONEWARE
GRÈS CÉRAME COLORE DANS LA MASSE/DURCHGEFÄRBTE FEINSTEINZEUG/GRES PORCELÁNICO COLOREADO EN MASA/керамогранит, окрашенный по всей тлщине
SQUADRATO - SQUARED - EQUARRI - REKTIFIZIERT - ESCUADRADO - КАЛИБРОВАННАЯ

				10 mm 3/8" ↑↓		80x180 31 1/2"x70 5/8"		80x80 31 1/2"x31 1/2"		60x120 23 5/8"x47 1/4"		30x120 11 4/5"x47 1/4"		60x60 23 5/8"x23 5/8"		30x60 11 4/5"x23 5/8"			
		COLOR	SURFACE																
PREXIOUS OF REX		PEARL ATTRACTION	GLOSSY	755819 ■ FL-11900	755831 ■ FL-10800	755847 ■ FL-11300	755859 ■ FL-12400	755871 ■ FL-09100	755884 ■ FL-07700										
			MATTE	755813 ■ FL-10500	755825 ■ FL-09300	755837 ■ FL-09900	755853 ■ FL-10800	755865 ■ FL-07300	755878 ■ FL-06200										
		DREAM ARABESQUE	GLOSSY	755818 ■ FL-11900	755830 ■ FL-10800	755846 ■ FL-11300	755858 ■ FL-12400	755870 ■ FL-09100	755883 ■ FL-07700										
			MATTE	755812 ■ FL-10500	755824 ■ FL-09300	755836 ■ FL-09900	755852 ■ FL-10800	755864 ■ FL-07300	755877 ■ FL-06200										
				6 mm 1/4" ↑↓		160x320 63"x126"		120x280 47 1/4"x110 1/4"		160x160 63"x63"		120x240 47 1/4"x94 1/4"		120x120 47 1/4"x47 1/4"		80x80 31 1/2"x31 1/2"		60x120 23 5/8"x47 1/4"	
PREXIOUS OF REX		DREAM ARABESQUE	GLOSSY	756427 ■ FL-18800	757738 ■ FL-15100	756439 ■ FL-16100	756287 ■ FL-14000	756391 ■ FL-12400	756415 ■ FL-10300	756403 ■ FL-11300									
			MATTE	756421 ■ FL-15600	757732 ■ FL-12400	756433 ■ FL-13400	756292 ■ FL-11300	756385 ■ FL-09700	756409 ■ FL-08400	756397 ■ FL-09100									

PREXIOUS OF REX

CHARMING AMBER



THUNDER NIGHT



DCOF>
0,42 Wet
(matte)

10 mm 3/8" ↑↓



DCOF>
0,42 Wet
(matte)

6 mm 1/4" ↑↓

FLOFORM OVERSIZE
magnum

GRES PORCELLANATO COLORATO IN MASSA/COLOURED BODY PORCELAIN STONEWARE
GRÈS CÉRAMÉ COLORE DANS LA MASSE/DURCHGEFÄRBTE FEINSTEINZEUG/GRES PORCELÁNICO COLOREADO EN MASA/керамогранит, окращенный по всей тлщине
SQUADRATO - SQUARED - EQUARRI - REKTIFIZIERT - ESCUADRADO - КАЛИБРОВАННАЯ

			10 mm 3/8" ↑↓		6 mm 1/4" ↑↓				
	COLOR	SURFACE	80x180 31 1/2" x 70 6/7"	80x80 31 1/2" x 31 1/2"	60x120 23 5/8" x 47 1/4"	30x120 11 4/5" x 47 1/4"	60x60 23 5/8" x 23 5/8"	30x60 11 4/5" x 23 5/8"	
PREXIOUS OF REX	CHARMING AMBER	GLOSSY	755817 ■ FL-11900	755829 ■ FL-10800	755845 ■ FL-11300	755857 ■ FL-12400	755869 ■ FL-09100	755882 ■ FL-07700	
		MATTE	755811 ■ FL-10500	755823 ■ FL-09300	755835 ■ FL-09900	755851 ■ FL-10800	755863 ■ FL-07300	755876 ■ FL-06200	
	THUNDER NIGHT	GLOSSY	755820 ■ FL-11900	755832 ■ FL-10800	755848 ■ FL-11300	755860 ■ FL-12400	755872 ■ FL-09100	755885 ■ FL-07700	
		MATTE	755814 ■ FL-10500	755826 ■ FL-09300	755838 ■ FL-09900	755854 ■ FL-10800	755866 ■ FL-07300	755879 ■ FL-06200	
PREXIOUS OF REX	CHARMING AMBER	GLOSSY	756428 ■ FL-18800	757739 ■ FL-15100	756440 ■ FL-16100	755840 ■ FL-14000	756392 ■ FL-12400	756416 ■ FL-10300	756404 ■ FL-11300
		MATTE	756422 ■ FL-15600	757733 ■ FL-12400	756434 ■ FL-13400	756294 ■ FL-11300	756386 ■ FL-09700	756410 ■ FL-08400	756398 ■ FL-09100
	THUNDER NIGHT	GLOSSY	756429 ■ FL-18800	757740 ■ FL-15100	756441 ■ FL-16100	756286 ■ FL-14000	756393 ■ FL-12400	756417 ■ FL-10300	756405 ■ FL-11300
		MATTE	756423 ■ FL-15600	757734 ■ FL-12400	756435 ■ FL-13400	756291 ■ FL-11300	756387 ■ FL-09700	756411 ■ FL-08400	756399 ■ FL-09100

PEZZI SPECIALI/SPECIAL TRIMS/PIÈCES SPÉCIALES
FORMSTÜCKE/PIEZAS ESPECIALES/Специальные изделия

10 mm 3/8" ↑

10 mm 3/8" ↑	COLOR	SURFACE	30x30 11 ^{4/5"} x11 ^{4/5"}	30x30 11 ^{4/5"} x11 ^{4/5"}	4,6x60 1 ^{4/5"} x23 ^{3/8"}	33x120x3 13"x47 ^{11/16"} x1 ^{1/8"}
			mosaico tessere 3x15 pz/box 11	mosaico 3D Mix tessere 3x3 pz/box 9	battiscopa	gradino pz/box 2
PREVIOUS OF REX	WHITE FANTASY	GLOSSY	756310 ▲ FL-02200	756316 ▲ FL-04900	756328 ◆ FL-01600	756340 ▲ FL-22600
		MATTE	756304 ▲ FL-02100		756322 ◆ FL-01600	756334 ▲ FL-20400
	MOUNTAIN TREASURE	GLOSSY	756311 ▲ FL-02200	756317 ▲ FL-04900	756329 ◆ FL-01600	756341 ▲ FL-22600
		MATTE	756305 ▲ FL-02100		756323 ◆ FL-01600	756335 ▲ FL-20400
	PEARL ATTRACTION	GLOSSY	756314 ▲ FL-02200	756320 ▲ FL-04900	756332 ◆ FL-01600	756344 ▲ FL-22600
		MATTE	756308 ▲ FL-02100		756326 ◆ FL-01600	756338 ▲ FL-20400
	DREAM ARABESQUE	GLOSSY	756313 ▲ FL-02200	756319 ▲ FL-04900	756331 ◆ FL-01600	756343 ▲ FL-22600
		MATTE	756307 ▲ FL-02100		756325 ◆ FL-01600	756337 ▲ FL-20400
	CHARMING AMBER	GLOSSY	756312 ▲ FL-02200	756318 ▲ FL-04900	756330 ◆ FL-01600	756342 ▲ FL-22600
		MATTE	756306 ▲ FL-02100		756324 ◆ FL-01600	756336 ▲ FL-20400
	THUNDER NIGHT	GLOSSY	756315 ▲ FL-02200	756321 ▲ FL-04900	756333 ◆ FL-01600	756345 ▲ FL-22600
		MATTE	756309 ▲ FL-02100		756327 ◆ FL-01600	756339 ▲ FL-20400







Per un effetto ottimale della posa, florim suggerisce di mantenere 2 mm di fuga per pose monoformato e 3 mm per combinare formati misti - For optimal installation results, florim recommends maintaining a joint of 2 mm 1/12" for single format installations and 3 mm 1/8" to combine mixed formats. - Pour réaliser une pose parfaite, florim suggère de maintenir 2 mm de joint pour la pose des monoformats, et 3 mm pour les combinaisons de formats mixtes. - Um einen optimalen effekt beim verlegen zu erzielen empfiehlt florim eine 2 mm fuge bei einformatigen verlegungen und 3 mm fuge bei formatkombinationen Para lograr los máximos resultados en la posa del producto, florim aconseja 2 mm de junta en aplicaciones monoformato y 3 mm en combinaciones de formatos mixtos - **ДЛЯ ОПТИМАЛЬНОЙ УКЛАДКИ " FLORIM" РЕКОМЕНДУЕТ ВЫДЕРЖИВАТЬ ЗАЗОР 2 ММ ДЛЯ МОНОФОРМАТА И 3 ММ ПРИ СМЕШАННЫХ ФОРМАТАХ.**

In relazione alle differenti tecnologie produttive l'accostamento di prodotti con spessori diversi potrebbe presentare delle disomogeneità, se ne sconsiglia pertanto l'abbinamento. / Due to the different production technologies, contiguous installation of products with different thickness may give a non-homogeneous result. For this reason we do not recommend this option. / Vu que différentes technologies de production sont utilisées avec des épaisseurs différentes, des problèmes d'homogénéité pourraient se présenter, il est donc déconseillé de les poser ensemble. / Wegen unterschiedlicher Produktionstechnologien können die Fliesen mit verschiedenen Materialstärken optische Differenzen aufweisen. Von einem direkten Aneinanderlegen wird deshalb abgeraten. / Dadas las diferentes tecnologías productivas, la combinación de productos de diferentes espesores podría dar lugar a heterogeneidad, por lo que se desaconseja mezclarlas. / В связи с различием в технологиях производства, сочетание продукции разной толщины иногда может представлять неоднородность материала. Такие сочетания следует избегать.





PREVIOUS OF REX	scatola - box			pallet		
	pz	mq	kg	box	mq	kg
80x180	2	2,88	67,20	20	57,60	1400
80x80	2	1,28	29,80	40	51,20	1220
60x120	2	1,44	31,70	30	43,20	980
30x120	3	1,08	23,80	20	21,60	500
60x60	3	1,08	23,80	40	43,20	980
30x60	6	1,08	24,00	40	43,20	980

PREVIOUS OF REX	scatola - box			pallet		
	pz	ml	kg	box	mq	kg
4,6x60 battiscopa	14	8,40	8,40	-	-	-

PREXIOUS OF REX

6 mm 1/4" ↑↓				30x30 11 4/5" x 11 4/5"  mosaico tessere 7,5x7,5 pz/box 11	30x30 11 4/5" x 11 4/5"  muretto tessere 7,5x15 pz/box 11
		COLOR	SURFACE		
PREXIOUS OF REX		WHITE FANTASY	GLOSSY	756364 ▲ FL-02100	756352 ▲ FL-02100
			MATTE	756358 ▲ FL-01800	756346 ▲ FL-01800
		DREAM ARABESQUE	GLOSSY	756367 ▲ FL-02100	756355 ▲ FL-02100
			MATTE	756361 ▲ FL-01800	756349 ▲ FL-01800
		CHARMING AMBER	GLOSSY	756366 ▲ FL-02100	756354 ▲ FL-02100
			MATTE	756360 ▲ FL-01800	756348 ▲ FL-01800
		THUNDER NIGHT	GLOSSY	756369 ▲ FL-02100	756357 ▲ FL-02100
			MATTE	756363 ▲ FL-01800	756351 ▲ FL-01800

PEZZI SPECIALI/SPECIAL TRIMS/PIÈCES SPÉCIALES/FORMSTÜCKE/PIEZAS ESPECIALES/Специальные изделия

6 mm 1/4" ↑↓				4,6x80 1 4/5" x 3 1/2"  battiscopa
		COLOR	SURFACE	
PREXIOUS OF REX		WHITE FANTASY	GLOSSY	756376 ◆ FL-01800
			MATTE	756370 ◆ FL-01800
		DREAM ARABESQUE	GLOSSY	756379 ◆ FL-01800
			MATTE	756373 ◆ FL-01800
		CHARMING AMBER	GLOSSY	756378 ◆ FL-01800
			MATTE	756372 ◆ FL-01800
		THUNDER NIGHT	GLOSSY	756381 ◆ FL-01800
			MATTE	756375 ◆ FL-01800

FLORM OVERSIZE
magnUm

160x320/120x280/160x160/120x240/120x120/60x120

Specifica Imballo pag.
Packaging specifications on page
Spécifications d'emballage à page
Verpackungsdetail Seite
Especificaciones de embalaje a la página
Информация об упаковке на стр.
200/201

Luxury design





RÊVES DE REX

gres porcellanato colorato in massa
coloured body porcelain stoneware
grès cérame colore dans la masse
durchgefärbte feinsteinzeug
gres porcelánico coloreado en masa
керамогранит, окращенный по всей толщине





RÊVES DE REX

Ispirata alla bellezza antica e ricercata degli alabastri, la collezione **Rêves de Rex** ci restituisce un sogno di contemporanea eleganza attraverso sfumature preziose e raffinate cromie in linea con le attuali inclinazioni estetiche dell'abitare. Morbide venature e tenui contrasti di colore contrassegnano una collezione essenziale ed equilibrata che con uno stile autentico prende le distanze dalle tinte accese e appariscenti. Superfici luminose, profonde e delicate accompagnano le diverse architetture senza offuscarle ma riuscendo ad esaltarne spazio e dimensione.

Inspired by the ancient and exquisite beauty of alabaster, the **Rêves de Rex** collection evokes a dream of contemporary elegance through fine shades and refined colours in line with current living space aesthetics. Soft veins and subtle colour contrasts mark an essential and balanced collection whose authentic style distances itself from bright and flashy colours. Glossy, deep and delicate surfaces pair with various architectures, never overshadowing but rather enhancing their space and size.

S'inspirant de la beauté ancienne et raffinée des albâtres, la collection **Rêves de Rex** nous offre un rêve d'élégance contemporaine à travers des nuances précieuses et des couleurs raffinées, en accord avec les tendances esthétiques actuelles de l'habitat. Les douces veines et les délicats contrastes de couleurs caractérisent cette collection sobre et équilibrée qui, de par son style authentique, se démarque des couleurs vives et criardes. Des surfaces lumineuses, profondes et délicates accompagnent les différentes architectures sans les éclipser, bien au contraire, car elles réussissent à mettre en valeur leurs espaces et leurs dimensions.

Die Kollektion **Rêves de Rex** inspiriert sich an der antiken und erlesenen Schönheit von Alabaster und liefert einen Traum von kontemporärer Eleganz, mit kostbaren Nuancen und raffinierten Farben, die den aktuellen ästhetischen Wohntrends entsprechen. Weiche Äderungen und zarte Farbkontraste kennzeichnen eine wesentliche und ausgewogene Kollektion, die mit einem authentischen Stil von den kräftigen und auffälligen Farben Abstand nimmt. Helle, tiefe und zarte Oberflächen begleiten die verschiedenen Architekturen, ohne sie zu trüben, sondern sie betonen dagegen den Raum und die Größe.

Inspirada en la belleza antigua y sofisticada del alabastro, la colección **Rêves de Rex** presenta un sueño de elegancia contemporánea a través de matices preciosos y refinados colores acordes con las inclinaciones estéticas actuales para el hogar. Los suaves veteados y los contrastes tenues de color caracterizan una colección esencial y equilibrada que, con auténtico estilo, se distancia de los tonos más vivos y llamativos. Las superficies luminosas, profundas y delicadas acompañan a las distintas arquitecturas sin eclipsarlas, antes bien, resaltando su espacio y sus dimensiones.

Коллекция **Rêves de Rex**, вдохновленная непреходящей красотой и элегантностью алебаstra, с ее великолепными оттенками и изысканными хроматическими комбинациями, отражающими актуальные тенденции в интерьерном дизайне, воплощает идеал современной роскоши. Нежные прожилки и мягкие цветовые контрасты отличают эту коллекцию с лаконичным и сдержанным дизайном, аутентичный стиль которой далек от ярких кричащих цветов. Наполненные светом, выразительные и деликатные поверхности гармонично оформляют самые разные архитектурные решения, не затеняя их, а напротив – визуально расширяя пространство и увеличивая размеры интерьера.

RÊVES DE REX

RÊVE PERLE



RÊVE BLEU

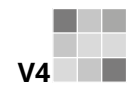

V4

DCOF>
0,42 Wet
(matte)

10 mm 3/8" ↓↑

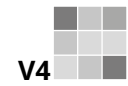

V4

DCOF>
0,42 Wet
(matte)

6 mm 1/4" ↓↑

FLOHM OVERSIZE
magnUm

GRES PORCELLANATO COLORATO IN MASSA/COLOURED BODY PORCELAIN STONWARE
GRÈS CÉRAME COLORE DANS LA MASSE/DURCHGEFÄRBT FEINSTEINZEUG/GRES PORCELÁNICO COLOREADO EN MASA/керамогранит, окращенный по всей тлщине
SQUADRATO - SQUARED - EQUARRI - REKTIFIZIERT - ESCUADRADO - КАЛИБРОВАННАЯ

10 mm 3/8" ↓↑		COLOR	SURFACE	80x180 31 1/2" x 70 6/7"	60x120 23 5/8" x 47 1/4"	60x60 23 5/8" x 23 5/8"	30x60 11 4/5" x 23 5/8"	
RÊVES DE REX		RÊVE PERLE	GLOSSY	770421 ■ FL-11900	769816 ■ FL-11300	769800 ■ FL-09100	769808 ■ FL-07700	
			MATTE	770417 ■ FL-10500	769812 ■ FL-09900	769795 ■ FL-07300	769804 ■ FL-06200	
		RÊVE BLEU	GLOSSY	770422 ■ FL-11900	769817 ■ FL-11300	769801 ■ FL-09100	769809 ■ FL-07700	
			MATTE	770418 ■ FL-10500	769813 ■ FL-09900	769796 ■ FL-07300	769805 ■ FL-06200	
6 mm 1/4" ↓↑		COLOR	SURFACE	160x320 63" x 126"	120x280 47 1/4" x 110 1/4"	120x240 47 1/4" x 94 1/2"	120x120 47 1/4" x 47 1/4"	60x120 23 5/8" x 47 1/4"
RÊVES DE REX		RÊVE PERLE	GLOSSY	769943 ■ FL-18800	769926 ■ FL-15100	769918 ■ FL-14000	769910 ■ FL-12400	769935 ■ FL-11300
			MATTE	769939 ■ FL-15600	769922 ■ FL-12400	769914 ■ FL-11300	769906 ■ FL-09700	769931 ■ FL-09100
		RÊVE BLEU	GLOSSY	769940 ■ FL-18800	769923 ■ FL-15100	769915 ■ FL-14000	769907 ■ FL-12400	769932 ■ FL-11300
			MATTE	769936 ■ FL-15600	769919 ■ FL-12400	769911 ■ FL-11300	769903 ■ FL-09700	769928 ■ FL-09100

RÊVE NOISETTE



RÊVE CHOCO

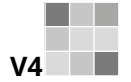

V4
DCOF >
0,42 Wet
(matte)

10 mm 3/8" ↑ ↓

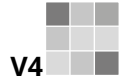





V4
DCOF >
0,42 Wet
(matte)

6 mm 1/4" ↑ ↓

FLORM OVERSIZE
magnUm

GRES PORCELLANATO COLORATO IN MASSA/COLOURED BODY PORCELAIN STONEWARE
GRÈS CÉRAME COLORE DANS LA MASSE/DURCHGEFÄRBTE FEINSTEINZEUG/GRES PORCELÁNICO COLOREADO EN MASA/керамогранит, окрашенный по всей тлщине
SQUADRATO - SQUARED - EQUARRI - REKTIFIZIERT - ESCUADRADO - КАЛИБРОВАННАЯ

			10 mm 3/8" ↑ ↓					
		COLOR	SURFACE	80x180 31 1/2"x70 6/7"	60x120 23 5/8"x47 1/4"	60x60 23 5/8"x23 5/8"	30x60 11 4/5"x23 5/8"	
RÊVES DE REX		RÊVE NOISETTE	GLOSSY	770423 ■ FL-11900	769818 ■ FL-11300	769802 ■ FL-09100	769810 ■ FL-07700	
			MATTE	770419 ■ FL-10500	769814 ■ FL-09900	769797 ■ FL-07300	769806 ■ FL-06200	
		RÊVE CHOCO	GLOSSY	770424 ■ FL-11900	769819 ■ FL-11300	769803 ■ FL-09100	769811 ■ FL-07700	
			MATTE	770420 ■ FL-10500	769815 ■ FL-09900	769798 ■ FL-07300	769807 ■ FL-06200	
			6 mm 1/4" ↑ ↓					
		COLOR	SURFACE	160x320 63"x126"	120x280 47 1/4"x110 1/4"	120x240 47 1/4"x94 1/2"	120x120 47 1/4"x47 1/4"	60x120 23 5/8"x47 1/4"
RÊVES DE REX		RÊVE NOISETTE	GLOSSY	769942 ■ FL-18800	769925 ■ FL-15100	769917 ■ FL-14000	769909 ■ FL-12400	769934 ■ FL-11300
			MATTE	769938 ■ FL-15600	769921 ■ FL-12400	769913 ■ FL-11300	769905 ■ FL-09700	769930 ■ FL-09100
		RÊVE CHOCO	GLOSSY	769941 ■ FL-18800	769924 ■ FL-15100	769916 ■ FL-14000	769908 ■ FL-12400	769933 ■ FL-11300
			MATTE	769937 ■ FL-15600	769920 ■ FL-12400	769912 ■ FL-11300	769904 ■ FL-09700	769929 ■ FL-09100

RÊVES DE REX

RÊVE ROSE



RÊVE JADE

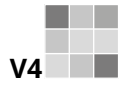

DCOF>
0,42 Wet
(matte)

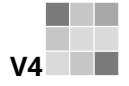

DCOF>
0,42 Wet
(matte)



FLOHM OVERSIZE
magnUlm

GRÉS PORCELLANATO COLORATO IN MASSA/COLOURED BODY PORCELAIN STONEWARE
GRÈS CÉRAME COLORE DANS LA MASSE/DURCHGEFÄRBTE FEINSTEINZEUG/GRES PORCELÁNICO COLOREADO EN MASA/керамогранит, окрашенный по всей тлщине
SQUADRATO - SQUARED - EQUARRI - REKTIFIZIERT - ESCUADRADO - КАЛИБРОВАННАЯ









		10 mm 3/8" ↓↑		80x180 31 1/2"x70 6/7"		60x120 23 5/8"x47 1/4"							
RÊVES DE REX	RÊVE ROSE	GLOSSY	774995 ■ FL-11900	775000 ■ FL-11300									
		MATTE	774993 ■ FL-10500	774998 ■ FL-09900									
	RÊVE JADE	GLOSSY	774994 ■ FL-11900	774999 ■ FL-11300									
		MATTE	774992 ■ FL-10500	774996 ■ FL-09900									
		6 mm 1/4" ↓↑		160x320 63"x126"		120x280 47 1/4"x110 1/4"		120x240 47 1/4"x94 1/2"		120x120 47 1/4"x47 1/4"		60x120 23 5/8"x47 1/4"	
RÊVES DE REX	RÊVE ROSE	GLOSSY	774489 ■ FL-18800	774483 ■ FL-15100	774493 ■ FL-14000	774497 ■ FL-12400	774501 ■ FL-11300						
		MATTE	774488 ■ FL-15600	774482 ■ FL-12400	774492 ■ FL-11300	774496 ■ FL-09700	774500 ■ FL-09100						
	RÊVE JADE	GLOSSY	774487 ■ FL-18800	774481 ■ FL-15100	774491 ■ FL-14000	774495 ■ FL-12400	774499 ■ FL-11300						
		MATTE	774485 ■ FL-15600	774480 ■ FL-12400	774490 ■ FL-11300	774494 ■ FL-09700	774498 ■ FL-09100						

Luxury design



RÊVES DE REX

PEZZI SPECIALI/SPECIAL TRIMS/PIÈCES SPÉCIALES
FORMSTÜCKE/PIEZAS ESPECIALES/Специальные изделия







10 mm 3/8" ↑		COLOR	SURFACE	30x30 11 ^{4/5"} x11 ^{4/5"}  mosaico tessere 3x15 pz/box 11	30x30 11 ^{4/5"} x11 ^{4/5"}  mosaico mix tessere 3x3 pz/box 9	4,6x60 1 ^{4/5"} x23 ^{5/8"}  battiscopa	33x120x3 13 ^{1/4"} x47 ^{1/4"} x1 ^{1/8"}  gradino pz/box 2
RÊVES DE REX		RÊVE PERLE	GLOSSY	770257 ▲ FL-02200	770249 ▲ FL-04900	770265 ◆ FL-01600	770273 ▲ FL-22600
			MATTE	770253 ▲ FL-02100		770261 ◆ FL-01600	770269 ▲ FL-20400
		RÊVE BLEU	GLOSSY	770254 ▲ FL-02200	770246 ▲ FL-04900	770262 ◆ FL-01600	770270 ▲ FL-22600
			MATTE	770250 ▲ FL-02100		770258 ◆ FL-01600	770266 ▲ FL-20400
		RÊVE NOISETTE	GLOSSY	770256 ▲ FL-02200	770248 ▲ FL-04900	770264 ◆ FL-01600	770272 ▲ FL-22600
			MATTE	770252 ▲ FL-02100		770260 ◆ FL-01600	770268 ▲ FL-20400
		RÊVE CHOCO	GLOSSY	770255 ▲ FL-02200	770247 ▲ FL-04900	770263 ◆ FL-01600	770271 ▲ FL-22600
			MATTE	770251 ▲ FL-02100		770259 ◆ FL-01600	770267 ▲ FL-20400

Per un effetto ottimale della posa, florim suggerisce di mantenere 2 mm di fuga per pose monoformato e 3 mm per combinare formati misti. - For optimal installation results, florim recommends maintaining a joint of 2 mm - 1/12" for single format installations and 3 mm - 1/8" to combine mixed formats. - Pour réaliser une pose parfaite, florim suggère de maintenir 2 mm de joint pour la pose des monoformats, et 3 mm pour les combinaisons de formats mixtes. - Um einen optimalen effekt beim verlegen zu erzielen empfiehlt florim eine 2 mm fugе bei einformatigen verlegungen und 3 mm fugе bei formatkombinationen. Para lograr los máximos resultados en la posa del producto, florim aconseja 2 mm de junta en aplicaciones monoformato y 3 mm en combinaciones de formatos mixtos - **ДЛЯ ОПТИМАЛЬНОЙ УКЛАДКИ * FLORIM * РЕКОМЕНДУЕТ ВЫДЕРЖИВАТЬ ЗАЗОР 2 ММ ДЛЯ МОНОФОРМАТА И 3 ММ ПРИ СМЕШАННЫХ ФОРМАТАХ.**





In relazione alle differenti tecnologie produttive l'accostamento di prodotti con spessori diversi potrebbe presentare delle disomogeneità, se ne sconsiglia pertanto l'abbinamento. / Due to the different production technologies, contiguous installation of products with different thickness may give a non-homogeneous result. For this reason we do not recommend this option. / Vu que différentes technologies de production sont utilisées avec des épaisseurs différentes, des problèmes d'homogénéité pourraient se présenter, il est donc déconseillé de les poser ensemble. / Wegen unterschiedlicher Produktionstechnologien können die Fliesen mit verschiedenen Materialstärken optische Differenzen aufweisen. Von einem direkten Aneinanderlegen wird deshalb abgeraten. / Dadas las diferentes tecnologías productivas, la combinación de productos de diferentes espesores podría dar lugar a heterogeneidad, por lo que se desaconseja mezclarlas. / **В связи с различием в технологиях производства, сочетание продукции разной толщины иногда может представлять неоднородность материала. Такие сочетания следует избегать.**

RÊVES DE REX	scatola - box			pallet		
	pz	mq	kg	box	mq	kg
80x180	2	2,88	67,20	20	57,60	1400
60x120	2	1,44	31,70	30	43,20	980
60x60	3	1,08	23,80	40	43,20	980
30x60	6	1,08	24,10	40	43,20	990

RÊVES DE REX	scatola - box			pallet		
	pz	ml	kg	box	mq	kg
4,6x60 battiscopa	14	8,40	8,40	-	-	-

6 mm 1/4" ↑↓				30x30 11 4/5" x 11 4/5"  mosaico tessere 7,5x7,5 pz/box 11	30x30 11 4/5" x 11 4/5"  muretto tessere 7,5x15 pz/box 11
		COLOR	SURFACE		
RÊVES DE REX		RÊVE PERLE	GLOSSY	770289 ▲ FL-02100	770281 ▲ FL-02100
			MATTE	770285 ▲ FL-01800	770277 ▲ FL-01800
		RÊVE BLEU	GLOSSY	770286 ▲ FL-02100	770278 ▲ FL-02100
			MATTE	770282 ▲ FL-01800	770274 ▲ FL-01800
		RÊVE NOISETTE	GLOSSY	770288 ▲ FL-02100	770280 ▲ FL-02100
			MATTE	770284 ▲ FL-01800	770276 ▲ FL-01800
		RÊVE CHOCO	GLOSSY	770287 ▲ FL-02100	770279 ▲ FL-02100
			MATTE	770283 ▲ FL-01800	770275 ▲ FL-01800

PEZZI SPECIALI/SPECIAL TRIMS/PIÈCES SPÉCIALES/FORMSTÜCKE/PIEZAS ESPECIALES/Специальные изделия

6 mm 1/4" ↑↓				4,6x60 1 4/5" x 23 5/8"  battiscopa
		COLOR	SURFACE	
RÊVES DE REX		RÊVE PERLE	GLOSSY	770298 ▲ FL-01800
			MATTE	770294 ▲ FL-01800
		RÊVE BLEU	GLOSSY	770295 ▲ FL-01800
			MATTE	770291 ▲ FL-01800
		RÊVE NOISETTE	GLOSSY	770297 ▲ FL-01800
			MATTE	770293 ▲ FL-01800
		RÊVE CHOCO	GLOSSY	770296 ▲ FL-01800
			MATTE	770292 ▲ FL-01800

FLOHM OVERSIZE
magnlum

160x320/120x280/120x240/120x120/60x120

Specifica Imballo pag.
Packaging specifications on page
Spécifications d'emballage à page
Verpackungsdetail Seite
Especificaciones de embalaje a la página
Информация об упаковке на стр.
200/201



SELECTION OAK

gres fine porcellanato
fine porcelain stoneware
grès cérame fin
feinsteinzeug-kollektionen
gres porcelánico fino
фарфоровый керамогранит





SELECTION OAK

L'essenza del rovere come ispirazione, una texture morbida e vellutata, 5 tonalità, selezionate con raffinata precisione, che ricordano le chiare atmosfere del mare e i caldi colori delle foreste incontaminate dove l'imperfezione della natura diventa perfetta armonia di toni e sfumature. Rex ha scelto un nuovo stile, una superficie che si richiama fortemente alla natura e porta con sé molteplici suggestioni, scelta per convivere con gli spazi e gli oggetti della memoria mescolati alle nuove proposte dell'architettura e dell'arredamento.

Taking its inspiration from oak wood, this has a soft, velvety texture and comes in 5 colours, selected with high-class precision to remind us of the light atmospheres of the sea and the warm colours of uncontaminated forests, where nature's imperfections turn into a perfect harmony of tones and shades. Rex has chosen a new style: the surface, strongly reminiscent of the natural world and bringing with it a wealth of delightful features, has been selected to blend into spaces and objects from past times mixed with new suggestions for architecture and furnishings.

L'essence de chêne comme source d'inspiration, avec une texture douce et veloutée. 5 tonalités sélectionnées avec précision et raffinement évoquent les atmosphères claires de la mer et les couleurs chaudes des forêts vierges, où l'imperfection de la nature compose une harmonie parfaite de tons et de nuances. Rex a choisi un nouveau style, une surface rappelant avec force la nature et portant en elle de multiples suggestions, pour accompagner les espaces et les objets de la mémoire associés aux nouvelles propositions de l'architecture et de la décoration.

Das Wesen der Eiche als Inspiration, eine weiche und samtige Beschaffenheit, 5 mit raffinierter Präzision ausgewählte Farbtöne, die an die klaren Stimmungen des Meers und die warmen Farben der unberührten Wälder erinnern, wo die Unvollkommenheit der Natur zur perfekten Harmonie von Tönen und Nuancen wird. Rex hat einen neuen Stil gewählt, eine Oberfläche, die sich stark an die Natur anlehnt und vielfältige Eindrücke hinterlässt, und die mit den Räumen und den Gegenständen der Erinnerung, vermischt mit dem neuen Angebot der Architektur und der Inneneinrichtung, auflebt.

La madera de roble como inspiración, una textura suave y aterciopelada, 5 tonalidades, seleccionadas con refinada precisión, que recuerdan las claras atmósferas del mar y los cálidos colores de las selvas incontaminadas, en las cuales la imperfección de la naturaleza se transforma en una perfecta armonía de tonos y matices. Rex ha elegido un nuevo estilo, una superficie que armoniza fuertemente con la naturaleza y consta de múltiples sugerencias, elegida para convivir con los espacios y los objetos de la memoria mezclados con nuevas propuestas arquitectónicas y decorativas.

Вдохновение черпается в древесине дуба. Текстура - мягкая и бархатистая. 5 оттенков, точно и изысканно отобранных, напоминают о светлых морских атмосферах и теплых цветах девственных лесов, где несовершенство природы превращается в совершенную гармонию тонов и нюансов. Rex выбрала новый стиль: поверхность, навеянная духом природы и пропитанная многочисленными ощущениями, используется для сосуществования былых мест и предметов с новыми предложениями архитектуры и обстановки.

SELECTION OAK

WHITE OAK



CREAM OAK



V3

R9
(matte)

R11
CLASSE C
(strutturato)

DCOF >
0,42 Wet

10 mm 3/8" ↑↓

GRES FINE PORCELLANATO

FINE PORCELAIN STONEWARE/GRES CERAME FIN/FEINSTEINZEUG-KOLLEKTIONEN/GRES PORCELANICO FINO/ФАРФОРОВЫЙ КЕРАМОГРАНИТ

SQUADRATO - SQUARED - EQUARRI - REKTIFIZIERT - ESCUADRADO - КАЛИБРОВАННАЯ

			10 mm 3/8" ↑↓	26,5x180 10 ^{3/7"} x70 ^{6/7"}	20x180 7 ^{7/8"} x70 ^{6/7"}	20x120 7 ^{7/8"} x47 ^{1/4"}	15x120 6"x47 ^{1/4"}	22,5x90 8 ^{6/7"} x35 ^{3/7"}	15x90 6"x35 ^{3/7"}
SELECTION OAK	WHITE OAK	MATTE	737647 ■ FL-12400	737653 ■ FL-12400	737659 ■ FL-09300	737665 ■ FL-09300	737673 ■ FL-07700	737679 ■ FL-07700	
		STRUTTURATO	-	-	-	-	-	737685 ■ FL-07700	
	CREAM OAK	MATTE	737648 ■ FL-12400	737654 ■ FL-12400	737660 ■ FL-09300	737666 ■ FL-09300	737674 ■ FL-07700	737680 ■ FL-07700	
		STRUTTURATO	-	-	-	-	-	737686 ■ FL-07700	

AMBER OAK

BROWN OAK



V3

R9
(matte)

R11
CLASSE C
(strutturato)

DCOF>
0,42 Wet

10 mm 3/8" ↑↓

GRES FINE PORCELLANATO

FINE PORCELAIN STONEWARE/GRES CERAME FIN/FEINSTEINZEUG-KOLLEKTIONEN/GRES PORCELANICO FINO/ФАРФОРОВЫЙ КЕРАМОГРАНИТ

SQUADRATO - SQUARED - EQUARRI - REKTIFIZIERT - ESCUADRADO - КАЛИБРОВАННАЯ

10 mm 3/8" ↑↓	COLOR	SURFACE	26,5x180 10 ^{3/7"} x70 ^{6/7"}	20x180 7 ^{7/8"} x70 ^{6/7"}	20x120 7 ^{7/8"} x47 ^{1/4"}	15x120 6"x47 ^{1/4"}	22,5x90 8 ^{6/7"} x35 ^{3/7"}	15x90 6"x35 ^{3/7"}
SELECTION OAK	AMBER OAK	MATTE	737650 ■ FL-12400	737656 ■ FL-12400	737662 ■ FL-09300	737668 ■ FL-09300	737676 ■ FL-07700	737682 ■ FL-07700
		STRUTTURATO	-	-	-	-	-	737688 ■ FL-07700
	BROWN OAK	MATTE	737651 ■ FL-12400	737657 ■ FL-12400	737663 ■ FL-09300	737669 ■ FL-09300	737677 ■ FL-07700	737683 ■ FL-07700
		STRUTTURATO	-	-	-	-	-	737689 ■ FL-07700

SELECTION OAK

GRAY OAK



R9
(matte)

R11
CLASSE C
(strutturato)

DCOF >
0,42 Wet

10 mm 3/8" ↑↓

GRES FINE PORCELLANATO

FINE PORCELAIN STONEWARE/GRES CERAME FIN/FEINSTEINZEUG-KOLLEKTIONEN/GRES PORCELANICO FINO/ФАРФОРОВЫЙ КЕРАМОГРАНИТ

SQUADRATO - SQUARED - EQUARRI - REKTIFIZIERT - ESCUADRADO - КАЛИБРОВАННАЯ

			10 mm 3/8" ↑↓						
		COLOR	SURFACE	26,5x180 10 ^{3/7"} x70 ^{6/7"}	20x180 7 ^{7/8"} x70 ^{6/7"}	20x120 7 ^{7/8"} x47 ^{1/4"}	15x120 6"x47 ^{1/4"}	22,5x90 8 ^{6/7"} x35 ^{3/7"}	15x90 6"x35 ^{3/7"}
SELECTION OAK		GRAY OAK	MATTE	747649 ■ FL-12400	737655 ■ FL-12400	737661 ■ FL-09300	737667 ■ FL-09300	737675 ■ FL-07700	737681 ■ FL-07700
			STRUTTURATO	-	-	-	-	-	737687 ■ FL-07700

10 mm 3/8" ↑↓				30x30 11 ^{4/5"} x11 ^{4/5"}	21x40 8 ^{1/4"} x15 ^{3/4"}
	COLOR	SURFACE		modulo listello tessere 7,5x30 pz/box 6	modulo listello sfalsato pz/box 6
	WHITE OAK	MATTE		738021 ▲ FL-01160	738014 ▲ FL-02300
	CREAM OAK	MATTE		738022 ▲ FL-01160	738015 ▲ FL-02300
SELECTION OAK	AMBER OAK	MATTE		738024 ▲ FL-01160	738017 ▲ FL-02300
	BROWN OAK	MATTE		738025 ▲ FL-01160	738018 ▲ FL-02300
	GRAY OAK	MATTE		738023 ▲ FL-01160	738016 ▲ FL-02300

PEZZI SPECIALI/SPECIAL TRIMS/PIÈCES SPÉCIALES/FORMSTÜCKE/PIEZAS ESPECIALES/Специальные изделия

10 mm 3/8" ↑↓				4,6x60 1 ^{4/5"} x23 ^{5/8"}	15x45x6 6"x17 ^{5/8"} x2 ^{1/3"}	33x120x3 13"x47 ^{1/4"} x1 ^{1/8"}	33x120x3 13"x47 ^{1/4"} x1 ^{1/8"}	33x120x3 13"x47 ^{1/4"} x1 ^{1/8"}	33x120x3 13"x47 ^{1/4"} x1 ^{1/8"}
	COLOR	SURFACE		battiscopa	elemento Elle strutturato	gradino pz/box 2	angolo gradino DX pz/box 2	angolo gradino SX pz/box 2	angolo gradino DXSX pz/box 1
	WHITE OAK	MATTE		745461 ◆ FL-01600	738113 ▲ FL-02400	738121 ▲ FL-21000	738127 ▲ FL-31100	738133 ▲ FL-31100	738139 ▲ FL-42900
	CREAM OAK	MATTE		745459 ◆ FL-01600	738114 ▲ FL-02400	738122 ▲ FL-21000	738128 ▲ FL-31100	738134 ▲ FL-31100	738140 ▲ FL-42900
SELECTION OAK	AMBER OAK	MATTE		745456 ◆ FL-01600	738116 ▲ FL-02400	738124 ▲ FL-21000	738130 ▲ FL-31100	738136 ▲ FL-31100	738142 ▲ FL-42900
	BROWN OAK	MATTE		745458 ◆ FL-01600	738117 ▲ FL-02400	738125 ▲ FL-21000	738131 ▲ FL-31100	738137 ▲ FL-31100	738143 ▲ FL-42900
	GRAY OAK	MATTE		745460 ◆ FL-01600	738115 ▲ FL-02400	738123 ▲ FL-21000	738129 ▲ FL-31100	738135 ▲ FL-31100	738141 ▲ FL-42900

Nelle operazioni di posa a listoni sfalsati, si raccomanda sempre di fare in modo che il lato maggiore della piastrella termini a circa un terzo della lunghezza di quelle accanto (posa sfalsata "a 1/3"). - When installing staggered strips, we recommend that the tile's longer side should always end at about one-third of the length of the tiles next to it ("1/3" staggered installation). - Lors de la pose des listels décalés, il faut toujours faire en sorte que le côté le plus grand du carreau se trouve à environ 1/3 de la longueur des carreaux d'à côté (pose décalée "à 1/3"). - Beim Verlegen der Leisten in versetzter Form ist zu beachten, dass die höhere Seite der Fliese immer circa bei einem Drittel der Länge der sich daneben befindlichen Fliesen abschließt ("Um 1/3" versetzte Verlegung). - En las operaciones de colocación de listones escalonados, se recomienda hacerlo siempre de forma tal que el lado mayor del azulejo termine teniendo alrededor de un tercio de la longitud de los contiguos (colocación escalonada "a 1/3"). - При укладке зигзагом следите за тем, чтобы более длинный край плиток заканчивался примерно на 1/3 длины соседних плиток (укладка зигзагом «1/3»).

Per un effetto ottimale della posa, florim suggerisce di mantenere 2 mm di fuga per pose monoformato e 3 mm per combinare formati misti. - For optimal installation results, florim recommends maintaining a joint of 2 mm - 1/16" for single format installations and 3 mm - 1/8" to combine mixed formats. - Pour réaliser une pose parfaite, florim suggère de maintenir 2 mm de joint pour la pose des monoformats, et 3 mm pour les combinaisons de formats mixtes. - Um einen optimalen effekt beim verlegen zu erzielen empfiehlt florim eine 2 mm fugе bei einformatigen verlegungen und 3 mm fugе bei formatkombinationen. Para lograr los máximos resultados en la posa del producto, florim aconseja 2 mm de junta en aplicaciones monoformato y 3 mm en combinaciones de formatos mixtos. - ДЛЯ ОПТИМАЛЬНОЙ УКЛАДКИ «FLORIM» РЕКОМЕНДУЕТ ВЫДЕРЖИВАТЬ ЗАЗОР 2 ММ ДЛЯ МОНОФОРМАТА И 3 ММ ПРИ СМЕШАННЫХ ФОРМАТАХ.

SELECTION OAK	scatola - box			pallet		
	pz	mq	kg	box	mq	kg
26,5x180	3	1,44	33,60	42	60,48	1470
20x180	4	1,44	34,20	40	57,60	1420
20x120	6	1,44	31,40	24	34,56	780
15x120	6	1,08	24,20	32	34,56	800
22,5x90	6	1,22	28,70	54	65,61	1570
15x90	6	0,81	18,20	72	58,32	1330

SELECTION OAK	scatola - box			pallet		
	pz	ml	kg	box	mq	kg
4,6x60 battiscopa	14	8,40	8,40	-	-	-

SELECTION OAK OUTDOOR

Vantaggi tecnici - Technical advantages - Avantages techniques Technische Vorteile - Ventajas técnicas - Технические преимущества

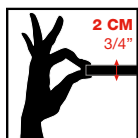

- Lastra monolitica compatta di spessore 2 cm squadrata e rettificata
- Compact monolithic slab 2 cm thick squared and rectified
- Dalle monolithique compacte de 2 cm d'épaisseur, équaree et rectifiée
- Kompakte monolithische Platte, 2 cm dick, rechteckig und scharfkantig geschliffen
- Losa monolítica compacta de 2 cm de espesor, escuadrada y rectificada.
- Монолитная плотная плита толщиной 2 см, с обрезанными и выровненными кромками

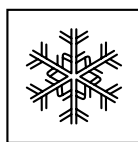

- INGELIVO
- FROST RESISTANT
- INGÉLIF
- FROSTBESTÄNDIG
- RESISTENTE A LA HELADA
- МОРОЗОСТОЙКАЯ

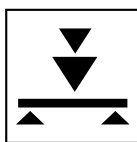

- ELEVATA RESISTENZA AI CARICHI STATICI
- HIGH STATIC LOAD RESISTANCE
- RÉSISTANCE ÉLEVÉE AUX CHARGES STATIQUES
- HOHE STATISCHE BELASTBARKEIT
- ELEVADA RESISTENCIA A LAS CARGAS ESTÁTICAS
- ВЫДЕРЖИВАЕТ БОЛЬШИЕ СТАТИЧЕСКИЕ НАГРУЗКИ

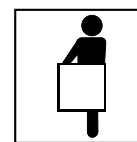

- FACILE DA POSARE
- EASY TO INSTALL
- FACILE À POSER
- VERLEGELEICHT
- FÁCIL DE COLOCAR
- ЛЕГКО УКЛАДЫВАЕТСЯ



- ANTISCIVOLO R11
- ANTI SLIP R11
- ANTIDÉRAPANT R11
- RUTSCHFEST R11
- ANTIDESLIZANTE R11
- НЕКОЛЬЗКАЯ - R11

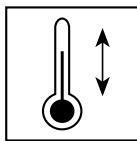

- RESISTENTE AGLI SBALZI TERMICI
- THERMAL SHOCK RESISTANT
- RÉSISTANT AUX ÉCARTS THERMIQUES
- TEMPERATURWECHSELBESTÄNDIG
- RESISTENTE A LAS OSCILACIONES TÉRMICAS
- СТОЙКАЯ К ТЕМПОВЫМ ПЕРЕПАДАМ



- FACILE DA PULIRE
- EASY TO CLEAN
- FACILE À NETTOYER
- REINIGUNGSEICHT
- FÁCIL DE LIMPIAR
- ЛЕГКО ЧИСТИТСЯ

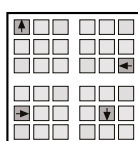

- RIMOVIBILE E RIUTILIZZABILE
- REMOVABLE AND REUSABLE
- DÉMONTABLE ET RÉUTILISABLE
- ENTFERNBAR UND WIEDERVERWENDBAR
- DESMONTABLE Y REUTILIZABLE
- МОЖЕТ СНИМАТЬСЯ И ПОВТОРНО ИСПОЛЬЗОВАТЬСЯ



- INATTACCABILE DA AGENTI CHIMICI E MUFFE
- IMPERVIOUS TO ATTACK BY CHEMICALS OR MOULD
- RÉSISTANT AUX AGENTS CHIMIQUES ET AUX MOISISSURES
- UNANGREIFBAR DURCH CHEMISCHE STOFFE UND SCHIMMEL
- RESISTENTE A LOS AGENTES QUÍMICOS Y A LOS MOHOS
- НЕ ПОДВЕРГАЕТСЯ ВОЗДЕЙСТВИЮ ХИМИЧЕСКИХ ВЕЩЕСТВ И ПЛЕСЕНИ

Applicazioni - Applications - Applications - Verlegung - Aplicaciones - Применения

- Posa diretta su erba
- Direct installation on grass
- Pose direct sur de l'herbe
- Verlegung direkt auf Rasen
- Colocación directa sobre hierba
- Прямая укладка на траву

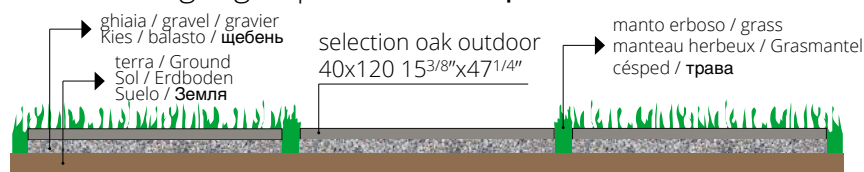

- Posa diretta su ghiaia
- Direct installation over gravel
- Pose direct sur du gravier
- Verlegung direkt auf Kies
- Colocación directa sobre grava
- Прямая укладка на гальку



- Posa su massetto cementizio
- Installation on sand-cement screed
- Pose sur chape ciment
- Verlegung auf Zement-Unterbetonblock
- Colocación sobre contrapiso de hormigón
- Укладка на цементную стяжку

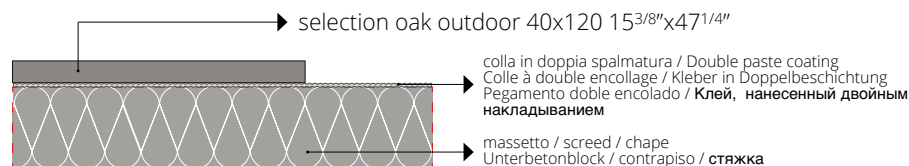

- Posa su piedini fissi o regolabili
- Installation on fixed or adjustable feet
- Pose sur pieds fixes ou réglables
- Verlegung auf feststehende oder regulierbare FüÙe
- Colocación sobre pies fijos o regulables
- Укладка на фиксированных или регулируемых ножках

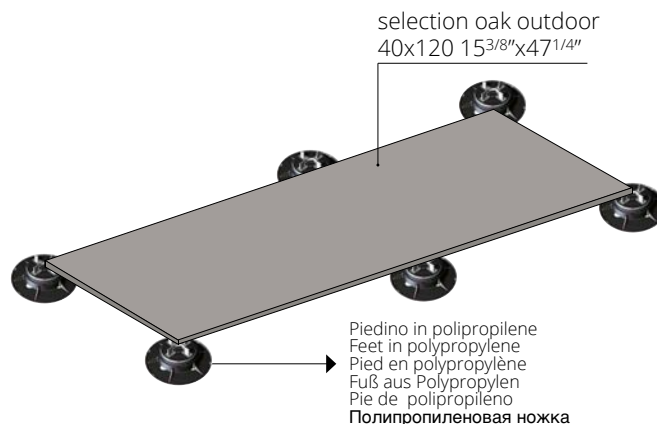

Per le specifiche di utilizzo dei sistemi sopraelevati vedi il sito florim.com
For the specifics on use of raised systems visit the site florim.com
Pour les caractéristiques d'utilisation des systèmes surélevés, voir le site florim.com
Für die Nutzungsbedingungen der Doppelbodensysteme siehe Webseite florim.com
Para las especificaciones de empleo de los sistemas sobreelevados consulte el sitio web florim.com
Технические характеристики систем фальшполов см. на сайте florim.com

Le lastre ceramiche sono sottoposte a un trattamento di compattazione termica che assicura resistenza e durata nel tempo. Il bassissimo assorbimento d'acqua rende perciò il materiale ingelivo. Ciò può comportare ristagni d'acqua superficiali anche per materiale installato a regola d'arte. / Ceramic tiles undergo a compacting thermal treatment that ensures resistance and durability. The low level of water absorption makes the slabs frost resistant. This could result in superficial water stagnations even if materials are installed in a workmanlike manner. / Les carreaux de céramique subissent un traitement thermique qui assure résistance et durabilité. Le bas niveau d'absorption d'eau rend les dalles résistant au gel. Il pourrait en résulter des stagnations d'eau superficielles, même si les dalles ont été installées dans les règles de l'art. / Die Keramikplatten werden einer thermischen Verdichtung unterzogen, welche die Widerstandsfähigkeit und Langlebigkeit sichert. Die extrem niedrige Wasseraufnahme macht das Material frostsicher. Die hohe Materialdichte kann, auch bei einer perfekten Verlegung, eine längere Abtrocknungszeit von angestaubtem Wasser zur Folge haben. / Las baldosas cerámicas se someten a un tratamiento de compactación térmica que asegura resistencia y durabilidad. La baja absorción de agua hace que las baldosas resistan al hielo. Esto podría resultar en estancamientos superficiales de agua, incluso si los materiales están instalados según las reglas del arte. / Керамическая плитка подвергается термическому уплотнению, что обеспечивает ей прочность и износостойкость. За счёт очень низкого водопоглощения она не промерзает, при этом даже при правильной укладке возможны застои воды на поверхности плитки.

AMBER OAK

GRAY OAK



R11
(strutturato)



CLASSE A+B

20 mm 3/4" ↑↓

GRES FINE PORCELLANATO

FINE PORCELAIN STONEWARE/GRES CERAME FIN/FEINSTEINZEUG-KOLLEKTIONEN/GRES PORCELANICO FINO/ФАРФОРОВЫЙ КЕРАМОГРАНИТ

SQUADRATO - SQUARED - EQUARRI - REKTIFIZIERT - ESCUADRADO - КАЛИБРОВАННАЯ

20 mm 3/4" ↑↓	COLOR	SURFACE	40x120 15 ^{3/4"} x47 ^{1/4"}
	AMBER OAK	STRUTTURATO	744635 ■ FL-10800
	GRAY OAK	STRUTTURATO	744636 ■ FL-10800

SELECTION OAK

	RESISTENZA ALLA FLESSIONE IN N/mm ² N/mm ² FLEXURAL STRENGTH TEST / RESISTANCE A LA FLEXION EN N/mm ² / BIEGESTÄRKEIT IN N/mm ² / RESISTENCIA A LA FLEXION EN N/mm ² / УСТОЙЧИВОСТЬ К ИЗГИБУ В Н/мм ²	valore medio 52 N/mm ²
	Forza di rottura in N (sp. > 7,5 mm) Breaking strength in N (thickness > 7,5 mm) / Force de rupture en N (ép. > 7,5 mm) / Bruchlast in N (Dicke > 7,5 mm) / Fuerza de rotura en N (gr. > 7,5 mm) / Разрушающее усилие, Н (толщ. > 7,5 мм)	valore medio 14000 N



PEZZI SPECIALI

Special trims/Pièces spéciales/Formstücke
Piezas especiales/СПЕЦИАЛЬНЫЕ ИЗДЕЛИЯ
pag 188/193

SELECTION OAK	scatola - box			pallet		
	pz	mq	kg	box	mq	kg
40x120 20mm	2	0,96	43,10	24	23,04	1060

OUTDOOR 20mm PEZZI SPECIALI

SPECIAL TRIMS
PIÈCES SPÉCIALES
FORMSTÜKE
PIEZAS ESPECIALES
СПЕЦИАЛЬНЫЕ ИЗДЕЛИЯ



CARATTERISTICHE TECNICHE



TECHNICAL FEATURES
CARACTÉRISTIQUES TECHNIQUES
TECHNISCHE EIGENSCHAFTEN
CARACTERÍSTICAS TÉCNICAS
ТЕХНИЧЕСКИЕ ХАРАКТЕРИСТИКИ

Pezzi speciali Outdoor 20mm

Special trims/Pièces spèciales/Formstüke / Piezas especiales/СПЕЦИАЛЬНЫЕ ИЗДЕЛИЯ

Collections:

La roche di rex - Matières de rex - Atmosphères de rex

Gradino toro

30x60 11^{4/5"}x23^{5/8"}_759176 ▲ FL-06400

40x120 15^{3/4"}x47^{1/4"}_759179 ▲ FL-20400

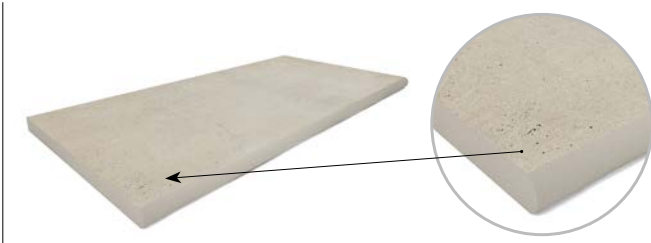

Collections:

Selection oak

Gradino toro

40x120 15^{3/4"}x47^{1/4"}_759179 ▲ FL-20400

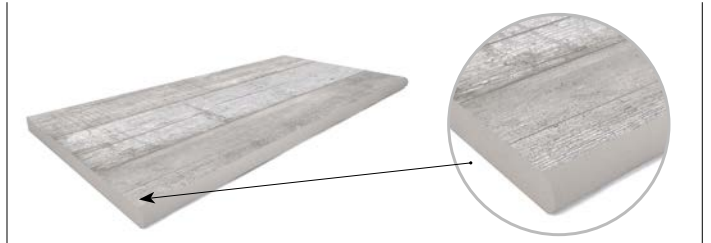

Gradino toro con gocciolatoio

30x60 11^{4/5"}x23^{5/8"}_759181 ▲ FL-09100

40x120 15^{3/4"}x47^{1/4"}_759184 ▲ FL-29000



Gradino toro con gocciolatoio

40x120 15^{3/4"}x47^{1/4"}_759184 ▲ FL-29000

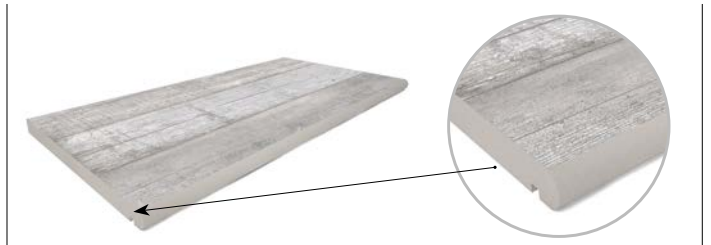

Gradino doppio toro

30x60 11^{4/5"}x23^{5/8"}_759186 ▲ FL-11300

40x120 15^{3/4"}x47^{1/4"}_759188 ▲ FL-36500

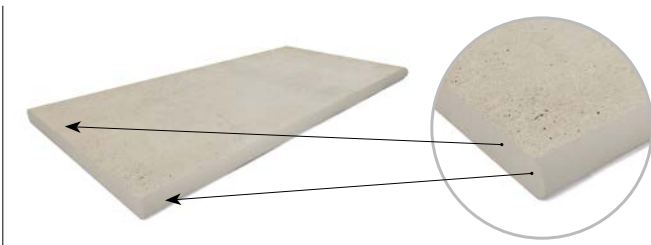

Gradino doppio toro

40x120 15^{3/4"}x47^{1/4"}_759188 ▲ FL-36500

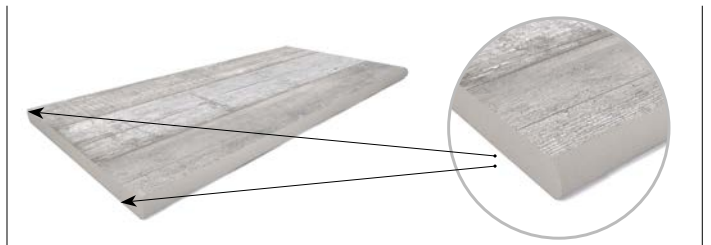

Gradino doppio toro con gocciolatoio

30x60 11^{4/5"}x23^{5/8"}_759190 ▲ FL-15600

40x120 15^{3/4"}x47^{1/4"}_759192 ▲ FL-29000

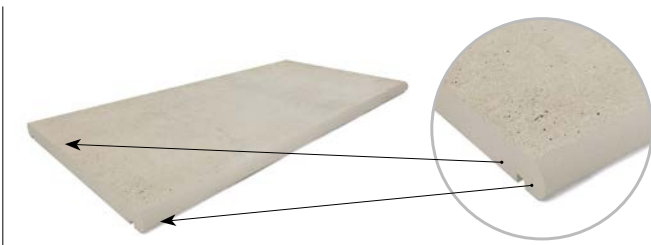

Gradino doppio toro con gocciolatoio

40x120 15^{3/4"}x47^{1/4"}_759192 ▲ FL-29000

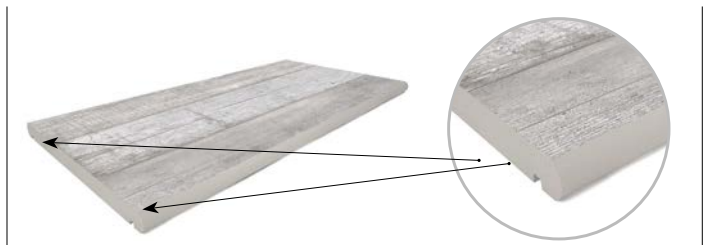

PEZZI SPECIALI OUTDOOR 20mm	scatola - box			pallet		
	pz	mq	kg	box	mq	kg
30x60 gradino toro	1	0,18	10,00	-	-	-
40x120 gradino toro	1	0,48	25,00	-	-	-
30x60 gradino toro con gocciolatoio	1	0,18	10,00	-	-	-
40x120 gradino toro con gocciolatoio	1	0,48	25,00	-	-	-
30x60 gradino doppio toro	1	0,18	10,00	-	-	-
40x120 gradino doppio toro	1	0,48	25,00	-	-	-
30x60 gradino doppio toro con gocciolatoio	1	0,18	10,00	-	-	-
40x120 gradino doppio toro con gocciolatoio	1	0,48	25,00	-	-	-

Collections:

La roche di rex - Matières de rex - Atmosphères de rex

Elemento ad Elle Angolo SX

30x60x8 $11\frac{4}{5}'' \times 23\frac{5}{8}'' \times 3\frac{1}{8}''$ _759203 ▲ FL-14500

40x120x8 $15\frac{3}{4}'' \times 47\frac{1}{4}'' \times 3\frac{1}{8}''$ _759214 ▲ FL-29000

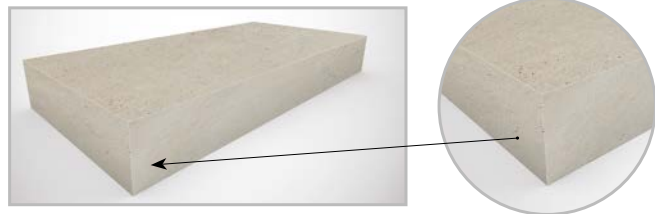

Elemento ad Elle Angolo SX

60x60x8 $23\frac{5}{8}'' \times 23\frac{5}{8}'' \times 3\frac{1}{8}''$ _759209 ▲ FL-19900

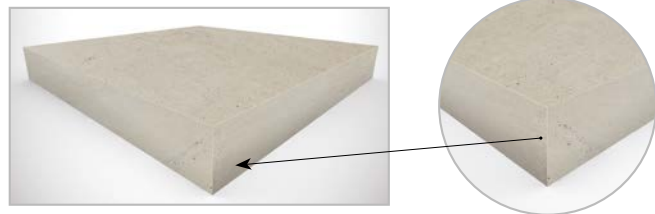

Elemento ad Elle

30x60x8 $11\frac{4}{5}'' \times 23\frac{5}{8}'' \times 3\frac{1}{8}''$ _759196 ▲ FL-09300

40x120x8 $15\frac{3}{4}'' \times 47\frac{1}{4}'' \times 3\frac{1}{8}''$ _759211 ▲ FL-19900

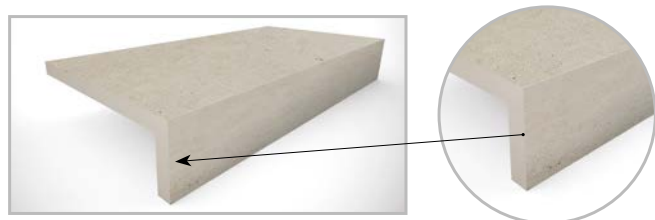

Elemento ad Elle

60x60x8 $23\frac{5}{8}'' \times 23\frac{5}{8}'' \times 3\frac{1}{8}''$ _759205 ▲ FL-14000

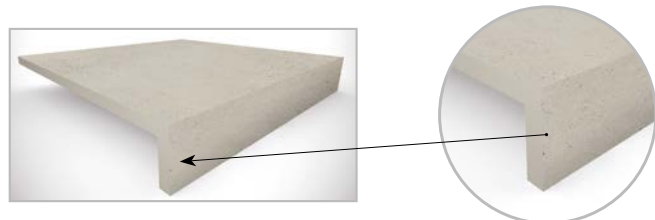

Elemento ad Elle Angolo DX

30x60x8 $11\frac{4}{5}'' \times 23\frac{5}{8}'' \times 3\frac{1}{8}''$ _759201 ▲ FL-14500

40x120x8 $15\frac{3}{4}'' \times 47\frac{1}{4}'' \times 3\frac{1}{8}''$ _759212 ▲ FL-29000

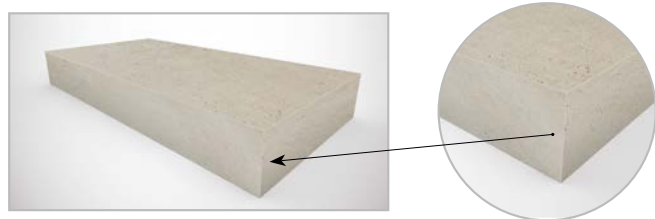

Elemento ad Elle Angolo DX

60x60x8 $23\frac{5}{8}'' \times 23\frac{5}{8}'' \times 3\frac{1}{8}''$ _759207 ▲ FL-19900

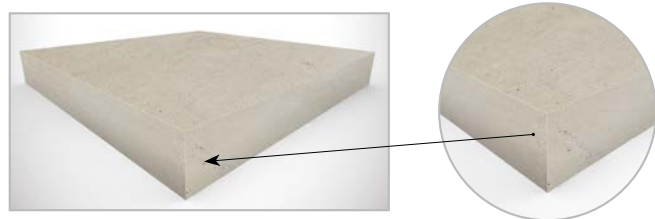

Pezzi speciali e fondo possono differire in termini di tonalità, il bordo può presentare stratificazioni di tonalità diverse.

Special pieces and field tiles may come in different shades, the slab's edge may show layers of differing hues.

Il peut y avoir des différences de tonalités entre les pièces spéciales et le fond, le bord pourrait présenter des stratifications de tonalités différentes.

Die Formteile können farblich von der Grundplatte abweichen, ihre Kanten können Schichtungen in unterschiedlichen Farbtönen aufweisen.

Piezas especiales y bases pueden diferir en términos de tonalidad, el borde puede presentar estratificaciones de diferente tonalidad.

Специальные элементы и фоновый материал могут отличаться по тону, край может иметь несколько слоев оттенков.

PEZZI SPECIALI OUTDOOR 20mm	scatola - box			pallet		
	pz	mq	kg	box	mq	kg
30x60x8 elemento ad elle angolo sx	1	0,18	10,00	-	-	-
40x120x8 elemento ad elle angolo sx	1	0,48	25,00	-	-	-
30x60x8 elemento ad elle	1	0,18	10,00	-	-	-
40x120x8 elemento ad elle	1	0,48	25,00	-	-	-
30x60x8 elemento ad elle angolo dx	1	0,18	10,00	-	-	-
40x120x8 elemento ad elle angolo dx	1	0,48	25,00	-	-	-
60x60x8 elemento ad elle angolo sx	1	0,36	20,00	-	-	-
60x60x8 elemento ad elle	1	0,36	20,00	-	-	-
60x60x8 elemento ad elle angolo dx	1	0,36	20,00	-	-	-

Pezzi speciali Outdoor 20mm

Special trims/Pièces spèciales/Formstüke / Piezas especiales/СПЕЦИАЛЬНЫЕ ИЗДЕЛИЯ

Collections:
Selection oak

Elemento ad Elle Angolo A SX

40x120x8 15^{3/4"}x47^{1/4"}x3^{1/8"}_753673 ▲ FL-29000

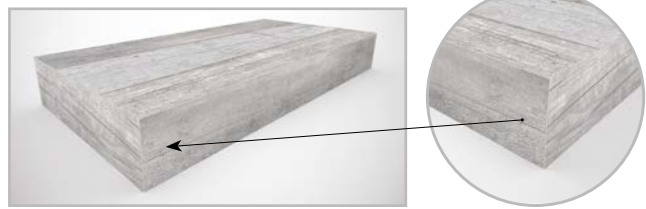

Elemento ad Elle A

40x120x8 15^{3/4"}x47^{1/4"}x3^{1/8"}_753670 ▲ FL-19900



Elemento ad Elle Angolo A DX

40x120x8 15^{3/4"}x47^{1/4"}x3^{1/8"}_753672 ▲ FL-29000

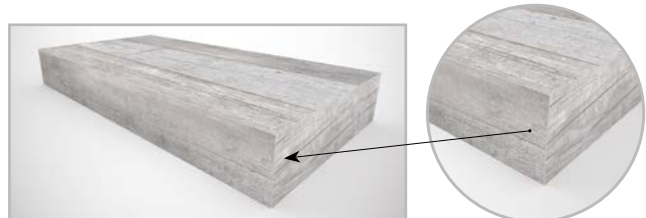

Elemento ad Elle Angolo B SX

40x120x8 15^{3/4"}x47^{1/4"}x3^{1/8"}_753849 ▲ FL-29000

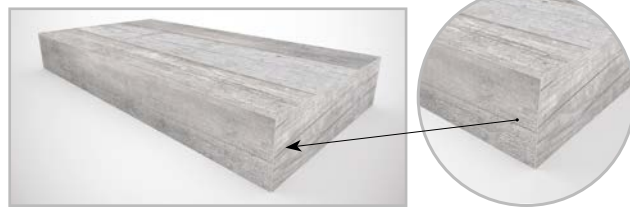

Elemento ad Elle B

40x120x8 15^{3/4"}x47^{1/4"}x3^{1/8"}_753671 ▲ FL-19900

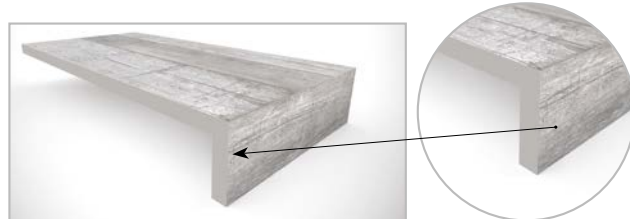

Elemento ad Elle Angolo B DX

40x120x8 15^{3/4"}x47^{1/4"}x3^{1/8"}_753848 ▲ FL-29000

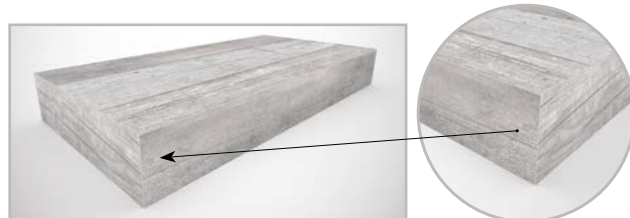

PEZZI SPECIALI OUTDOOR 20mm	scatola - box			pallet		
	pz	mq	kg	box	mq	kg
40x120x8 elemento ad elle angolo A sx	1	0,48	25,00	-	-	-
40x120 elemento ad elle A	1	0,48	25,00	-	-	-
40x120x8 elemento ad elle angolo A dx	1	0,48	25,00	-	-	-
40x120x8 elemento ad elle angolo B sx	1	0,48	25,00	-	-	-
40x120 elemento ad elle B	1	0,48	25,00	-	-	-
40x120x8 elemento ad elle angolo B dx	1	0,48	25,00	-	-	-

Collections: Selection oak



esempio di posa elemento elle A + angolo A SX
40x120x8 15^{3/4}"x47^{1/4}"



esempio di posa elemento elle B + angolo B SX
40x120x8 15^{3/4}"x47^{1/4}"

Pezzi speciali e fondo possono differire in termini di tonalità, il bordo può presentare stratificazioni di tonalità diverse.

Special pieces and field tiles may come in different shades, the slab's edge may show layers of differing hues.
Il peut y avoir des différences de tonalités entre les pièces spéciales et le fond, le bord pourrait présenter des stratifications de tonalités différentes.
Die Formteile können farblich von der Grundplatte abweichen, ihre Kanten können Schichtungen in unterschiedlichen Farbtönen aufweisen.
Piezas especiales y bases pueden diferir en términos de tonalidad, el borde puede presentar estratificaciones de diferente tonalidad.
Специальные элементы и фоновый материал могут отличаться по тону, край может иметь несколько слоев оттенков.

BORDO VASCA

SWIMMING POOL EDGE
BORD DE PISCINE
BECKENRAND
BORDE DE LA TINA
НРАЯ БАСЕЙНА



CARATTERISTICHE TECNICHE



TECHNICAL FEATURES
CARACTÉRISTIQUES TECHNIQUES
TECHNISCHE EIGENSCHAFTEN
CARACTERÍSTICAS TÉCNICAS
ТЕХНИЧЕСКИЕ ХАРАКТЕРИСТИКИ

WAVE/SPECIALPIECES

BORDO VASCA / SWIMMING POOL EDGE / BORD DE PISCINE
BECKENRAND / BORDE DE LA TINA / ПРЯЯ БАССЕЙНА

WAVE LINEARE



40,5x80 16"x31 1/2"

762863

▲ FL-21000

WAVE ANGOLO AE



40,5x40,5 16"x16"

762873

▲ FL-27900

WAVE ANGOLO AI 45°



40,5x80x80 16"x31 1/2"x31 1/2"

762868

▲ FL-44100

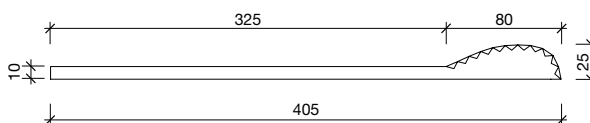
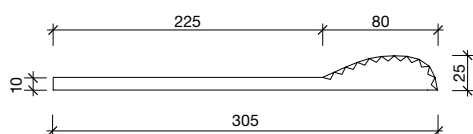

BORDO PER PISCINA "WAVE"

Rivoluzionario pezzo speciale che, attraverso l'accostamento di una serie di listelli opportunamente conformati su un lato del pezzo, rende ottimale la tracimazione, il contenimento dell'acqua, nonché l'appiglio manuale. La flessibilità progettuale di questo pezzo consente di realizzare bordi con diversi materiali Florim selezionati tra le serie che presentano le più elevate proprietà antiscivolo a piedi nudi (classe A+B+C, rif. norma DIN 51097).

"WAVE" SWIMMING POOL EDGE

Revolutionary border tile that, by placing together a set of suitably shaped strips on one side of the tile, makes an efficient overflow, containing the water and also offering a hand-grip. The flexibility of the design of this tile enables edges to be created with different Florim materials selected from the ranges that have the highest barefoot slip-resistance ratings (Class A+B+C, according to DIN 51097 standard).

BORD POUR PISCINE « WAVE »

Pièce spéciale révolutionnaire qui, grâce à la juxtaposition d'une série de listels dûment disposés sur un côté de la pièce, optimise le débordement, le confinement de l'eau, ainsi que le point d'accroche avec les mains. La flexibilité de conception de cette pièce permet de réaliser des bords avec différents matériaux Florim sélectionnés parmi les séries dotées des plus hautes propriétés antidérapantes pieds nus (classe A+B+C, réf. norme DIN 51097).

BECKENRANDSTEIN "WAVE"

Ein revolutionäres Spezialteil, das durch das Aneinandersetzen einer Reihe von Leisten, die an einer Seite des Spezialteils zweckmäßig geformt sind, eine ausgezeichnete Überflutung, Wassereindämmung und Griffkante bietet. Die flexible Projektanpassung dieses Spezialteils erlaubt die Gestaltung von Beckenrändern mit verschiedenen Florim-Materialien, ausgewählt unter den Produktserien mit der höchsten Barfuß-Rutschfestigkeit (Klasse A+B+C, Bezugsnorm DIN 51097).

BORDE PARA PISCINA «WAVE»

Pieza especial revolucionaria que se remata por un lado con una serie de listones de forma especial, para ofrecer un desbordamiento y retención del agua óptimos, así como un excelente asidero manual. La flexibilidad de diseño de esta pieza permite realizar bordes con varios materiales de Florim, seleccionados entre las series que presentan las más altas propiedades antideslizantes con pies descalzos (clase A+B+C, ref. norma DIN 51097).

БОРТ ДЛЯ БАССЕЙНА "WAVE"

Революционно новое специальное изделие, которое благодаря совмещению по одной стороне изделия ряда реек особенной формы, обеспечивает оптимальный перелив, удержание воды, а также захват для рук. Дизайнерская универсальность этого изделия позволяет выполнять борты из разнообразных материалов Florim, выбираемых из тех серий, которые обладают самыми высокими характеристиками нескользкости для босых ног (класс A+B+C, стандарт DIN 51097).

OCEAN/SPECIALPIECES

BORDO VASCA / SWIMMING POOL EDGE / BORD DE PISCINE
BECKENRAND / BORDE DE LA TINA / ПРЯЯ БАССЕЙНА

OCEAN LINEARE



32x80 12^{3/5"}x31^{1/2"}

762878

▲ FL-23600

OCEAN ANGOLO AE



30,5x30,5 12"x12"

762888

▲ FL-27900

OCEAN ANGOLO AI 45°



32x80x80 12^{3/5"}x31^{1/2"}x31^{1/2"}

762883

▲ FL-51500



BORDO PER PISCINA "OCEAN"

Innovativo e rivoluzionario pezzo speciale progettato appositamente per essere utilizzato come bordo piscina con sistema ad acqua traboccante a sfioro. E' composto da un pezzo che, attraverso l'accostamento di una serie di listelli opportunamente conformati su un lato del pezzo, rende ottimale la trascinabilità, il contenimento dell'acqua, nonché l'appiglio manuale. La flessibilità progettuale di questo pezzo consente di realizzare bordi con diversi materiali Florim selezionati tra le serie che presentano le più elevate proprietà antiscivolo a piedi nudi (classe A+B+C, rif. norma DIN 51097). Questo pezzo speciale comprende anche l'angolare in porcellanato per appoggio e contenimento griglia.

"OCEAN" SWIMMING POOL EDGE

Innovative, revolutionary border tile specially designed to be used as a swimming pool edge with overflow system. It comprises a piece that, by placing together a set of suitably shaped strips on one side of the tile, makes an efficient overflow, containing the water and also offering a hand-grip. The flexibility of the design of this tile enables edges with different Florim materials to be created, selecting them from the ranges that have the highest barefoot slip-resistance ratings (Class A+B+C, according to DIN 51097 standard). This special piece also includes the porcelain stoneware corner element for setting and containing the grating.

BORD POUR PISCINE « OCEAN »

Pièce spéciale innovante et révolutionnaire spécialement conçue pour être utilisée comme bord de piscine à débordement avec système de trop-plein. Grâce à la juxtaposition d'une série de listels dûment disposés sur un de ses côtés, cette pièce, optimise le débordement, le confinement de l'eau, ainsi que le point d'accroche avec les mains. La flexibilité de conception de cette pièce permet de réaliser des bords avec différents matériaux Florim sélectionnés parmi les séries dotées des plus hautes propriétés antidérapantes pieds nus (classe A+B+C, réf. norme DIN 51097). Cette pièce spéciale comprend également une pièce d'angle en grès cérame pour le support et le confinement de la grille.

BECKENRANDSTEIN "OCEAN"

Dieses innovative und revolutionäre Spezialteil wurde speziell für die Verwendung als Rand für Schwimmbecken mit Wasserüberlauftrinne entwickelt. Es besteht aus einem Teil, das durch das Aneinandersetzen einer Reihe von Leisten, die an einer Seite des Teils zweckmäßig geformt sind, eine ausgezeichnete Überflutung, Wassereindämmung und Griffkante bietet. Die flexible Projektanpassung dieses Spezialteils erlaubt die Gestaltung von Beckenrändern mit verschiedenen Florim-Materialien, ausgewählt unter den Produktserien mit der höchsten Barfuß-Rutschfestigkeit (Klasse A+B+C, Bezugsnorm DIN 51097). Dieses Spezialteil enthält auch das Eckstück aus Feinsteinzeug zur Aufnahme des Rostes.

BORDE PARA PISCINA «OCEAN»

Pieza especial, innovadora y revolucionaria, diseñada específicamente para usarse como borde de piscina con sistema de agua desbordante. Consta de una pieza que se remata por un lado con una serie de listones de forma especial, para ofrecer un desbordamiento y retención del agua óptimos, así como un excelente asidero manual. La flexibilidad de diseño de esta pieza permite realizar bordes con varios materiales de Florim, seleccionados entre las series que presentan las más altas propiedades antideslizantes con pies descalzos (clase A+B+C, ref. norma DIN 51097). Esta pieza especial también incluye la pieza angular de porcelánico de apoyo y sujeción de la rejilla.

БОРТ ДЛЯ БАССЕЙНА "OCEAN"

Иновационное и революционно новое специальное изделие, спроектированное специально для его использования в качестве борта бассейна с системой перелива. Оно состоит из детали, которая при совмещении с рядом реек особенной формы по одной стороне детали обеспечивает оптимальный перелив, удержание воды, а также захват для рук. Дизайнерская универсальность этого изделия позволяет выполнять борты из разнообразных материалов Florim, выбираемых из тех серий, которые обладают самыми высокими характеристиками нескользкости для босых ног (класс A+B+C, стандарт DIN 51097). Это специальное изделие включает в себя уголок из керамогранита для укладки и удержания решетки.

CARATTERISTICHE - VANTAGGI TECNICI

1. Modularità a base 60/80 cm (in base alla collezione scelta).
2. Facilità di posa, con collanti di normale uso per la ceramica.
3. Elevata leggerezza.
4. Alta resistenza meccanica ai carichi.
5. Sicurezza allo scivolamento.
6. Costanza e precisione dimensionale.
7. Ergonomia che facilita l'appiglio manuale.
8. Conformazione che ottimizza la tracimazione e il contenimento dell'acqua.
9. Massima igiene.
10. Totale impermeabilità.
11. Possibilità di realizzazione con diverse collezioni antiscivolo Florim.
12. Ridotta incidenza nel costo complessivo della vasca.
13. Il taglio dei pezzi in cantiere, deve essere fatto con sistemi adeguati (es. taglio ad acqua con disco diamantato).

TAGLI

E' possibile fornire pezzi tagliati a misura di varie forme e dimensioni. Prezzi e condizioni di vendita sono da stabilire, con specifica offerta da parte della divisione "FLORIM SOLUTIONS".

CARACTÉRISTIQUES - AVANTAGES TECHNIQUES

1. Modularité à la base 60/ 80 cm (en fonction de la collection choisie)
2. Facilité de pose, avec des adhésifs à usage normal pour la céramique.
3. Légèreté élevée.
4. Haute résistance mécanique aux charges.
5. Antidérapant.
6. Constance et précision dimensionnelles.
7. Ergonomie qui facilite la prise manuelle.
8. Conformation qui optimise le débordement et le confinement de l'eau.
9. Hygiène maximale.
10. Étanchéité totale.
11. Possibilité de mise en œuvre avec diverses collections Anti dérapant Florim.
12. Incidence réduite dans le coût global de la piscine.
13. La découpe des pièces sur le chantier doit être effectuée avec des systèmes adéquats (par ex. découpe à eau avec disque diamanté).

PIÈCES COUPÉES

Il est possible de fournir des pièces coupées sur mesure de diverses formes et dimensions. Prix et conditions de vente à établir avec une offre spécifique de la part de la division «FLORIM SOLUTIONS».

CARACTERÍSTICAS - VENTAJAS TÉCNICAS

1. Modularidad en base a 60/ 80 cm (según la colección elegida)
2. Facilidad de colocación, con encolados de uso normal para cerámicos.
3. Elevada ligereza.
4. Alta resistencia mecánica a las cargas.
5. Seguridad contra el deslizamiento.
6. Constancia y precisión dimensional.
7. Ergonomía que facilita el agarre manual.
8. Configuración que optimiza el desbordamiento y la contención del agua.
9. Máxima higiene.
10. Total impermeabilidad.
11. Posibilidad de realización con las distintas colecciones de antideslizantes Florim.
12. Reducida incidencia en el coste total de la tina.
13. El corte de las piezas en las obras se debe realizar con sistemas adecuados (por ejemplo: corte de agua con disco diamantado).

CORTES

Es posible proveer piezas cortadas a la medida de varias formas y dimensiones. Los precios y condiciones de venta se deben fijar mediante una oferta específica de la división "FLORIM SOLUTIONS".

TECHNICAL CHARACTERISTICS - ADVANTAGES

1. Modularity with 60/ 80 CM (based on the chosen collection)
2. Easy to lay with adhesives normally used for ceramic materials.
3. Ultra-light weight.
4. High mechanical load resistance.
5. Non-slip safety.
6. Dimensional constancy and precision.
7. Ergonomics that facilitate manual gripping.
8. Conformation that optimises the overflow and containment of water.
9. Maximum hygiene.
10. Total impermeability.
11. Possibility to create using different Florim antislip collections.
12. Reduced incidence on the total cost of the pool.
13. The cutting of the pieces on the work site must be done using suitable systems (e.g. water cut with diamond disk).

CUTS

It is possible to supply pieces cut to measure in various shapes and sizes. Prices and sales conditions are to be stipulated with a specific offer by the FLORIM SOLUTIONS Division.

MERKMALE - TECHNISCHE VORZÜGE

1. Modularität auf der Basis von 60/80 cm (basierend auf der ausgesuchten Kollektion)
2. Einfache Verlegung mit den üblichen Klebern für Keramik.
3. Äußerste Leichtigkeit.
4. Hohe mechanische Belastungsfestigkeit.
5. Rutschfestigkeit.
6. Maßbeständigkeit und -genauigkeit.
7. Ergonomische Form, die das Greifen mit der Hand erleichtert.
8. Beschaffenheit, die den Überlauf und die Eindämmung des Wassers optimiert.
9. Maximale Hygiene.
10. Vollkommene Wasserundurchlässigkeit.
11. Möglichkeit der Herstellung mit verschiedenen rutschfest Serien von Florim.
12. Geringe Auswirkung auf die Gesamtkosten des Beckens.
13. Das Schneiden der Teile an der Baustelle hat mit geeigneten Systemen (z.B. Wasserstrahlschneiden mit Diamantscheibe) zu erfolgen.

ZUSCHNITT

Es können nach Maß zugeschnittene Teile in verschiedenen Formen und Größen geliefert werden. Preise und Verkaufsbedingungen sind in speziellem Angebot der Abteilung "FLORIM SOLUTIONS" festzulegen.

ХАРАКТЕРИСТИКИ - ТЕХНИЧЕСКИЕ ПРЕИМУЩЕСТВА



1. Модульность со стандартом 60/80 см (в зависимости от выбранной коллекции)
2. Легкость кладки с использованием обычных замочков и мастик для керамики.
3. Повышенная легкость.
4. Повышенная механическая прочность к нагрузкам.
5. Безопасность в отношении подскользывания.
6. Размерная неизменность и точность.
7. Эргономика, облегчающая захват руками.
8. Форма, оптимизирующая погружение и удерживание в воде.
9. Максимальная гигиеничность.
10. Полная водонепроницаемость.
11. Возможность использования различных коллекций Florim с противоскользящей поверхностью
12. Низкий процент затрат по отношению к общей стоимости бассейна.
13. Нарезка элементов по месту кладки должна осуществляться с помощью соответствующих систем (напр., водная резка алмазным диском).

РАЗРЕЗАННЫЕ ДЕТАЛИ

Возможна поставка разрезанных под заказ деталей разных форм и размеров. Цены и условия продажи согласовываются отдельно, путем подготовки сметы подразделением компании «FLORIM SOLUTIONS».

WAVE/OCEAN/PACKAGES

WAVE LINEARE	40,5x80
WAVE ANGOLO AE	40,5x40,5
WAVE ANGOLO AI 45°	40,5x80x80
OCEAN LINEARE	32x80
OCEAN ANGOLO AE	30,5x30,5
OCEAN ANGOLO AI 45°	32x80x80

BOXES 			PALLETS 		
PZ	MQ	KG	PZ	MQ	KG
2	-	8,60	-	-	-
2	-	4,90	-	-	-
1	-	6,50	-	-	-
2	-	9,20	-	-	-
2	-	5,50	-	-	-
1	-	6,80	-	-	-

FLORIM OVERSIZE
magnUm[®]

IMBALLI E DECORI

PACKAGING AND DECORATIONS

EMBALLAGES ET DÉCORS

VERPACKUNGEN UND DEKORS

EMBALAJES Y DECORACIONES

УПАКОВКА И ДЕКОРЫ

TABELLA IMBALLI

PACKAGE TABLE/TABLEAU DE EMBALLAGES/TABELLE FORMATE/TABLA DE LOS EMBALAJES/Таблица упаковок
#6 SPESSORE / THICKNESS/ÉPAISSEUR/STÄRKE/ESPESOR/ТОЛЩИНА

			BOXES				PALLET		
			ML	PZ	MQ	KG	BOX	MQ	KG
	80x80	31 ^{1/2"} x31 ^{1/2"}	-	3	1,92	27,80	40	76,80	1140
	60x120	23 ^{5/8"} x47 ^{1/4"}	-	3	2,16	31,30	30	64,80	960
MOSAICO 1,5x3 MOSAICO 7,5x7,5 MURETTO 7,5x15	30x30	11 ^{4/5"} x11 ^{4/5"}	-	11	1,00	16,50	-	-	-
	30x30	11 ^{4/5"} x11 ^{4/5"}	-	11	1,00	16,50	-	-	-
	30x30	11 ^{4/5"} x11 ^{4/5"}	-	11	1,00	16,50	-	-	-
BATTISCOPIA	4,6x80	1 ^{4/5"} x31 ^{1/2"}	14,40	18	-	8,60	-	-	-
	4,6x60	1 ^{4/5"} x23 ^{5/8"}	14,40	24	-	8,60	-	-	-

DECORI/ DECORS FLORIM OVERSIZE magnUm

Note Imballo. Tutti i singoli pezzi tagliati vengono numerati con applicazione sulla parte a vista di un pezzo di nastro isolante dove è riportato il n° del pezzo. Le scatole sono rivestite internamente di polistirolo per garantire l'integrità dei singoli pezzi. Su ogni scatola è riportato: N° dei pezzi totali - Numerazione di ciascun pezzo. Sulla palette viene applicata una pallet card ed una busta in plastica contenente lo schema di montaggio. Per richieste di formati inferiori al modulo base (120x240 o 160x240), resta in vigore la richiesta di lavorazioni fuori standard. N. B. Il prezzo di listino del decoro si riferisce a formato standard. Eventuali lavorazioni su misura verranno valutate su richiesta. (Il servizio clienti è a disposizione per informazioni e ulteriori dettagli a riguardo).

Packing notes. Each individual cut piece is given a number. The piece number is shown on the exposed side of a strip of insulation tape. The boxes are padded on the inside with polystyrene to protect the individual pieces. Each box bears the following information: Total n° of pieces - Code number of each piece. The pallet comes with a pallet card and a plastic pouch containing the assembly diagram. For smaller sizes requests different from basic modules (120x240 or 160x240), you need to follow the procedure for requesting a non-standard format. N. B. The decor's price list refers to the standard format featuring one colour. Any custom-work will be assessed upon request. Please call our Customer Service for more information.

Remarques concernant l'emballage. Chaque pièce découpée est numérotée avec une application sur la partie visible d'un morceau de ruban isolant sur lequel figure le n° de la pièce. Les boîtes sont revêtues intérieurement de polystyrène afin de garantir l'intégrité de chaque pièce. Sur chaque boîte figurent: le nombre de pièces totales et la numérotation de chaque pièce. Une carte de la palette et un sachet en plastique contenant le schéma de montage sont appliqués sur la palette. Pour toute demande de formats inférieurs au module de base (120x240 ou 160x240), reste en vigueur la demande de hors standard. N. B. Le prix catalogue du décor se réfère au format standard. Les éventuels traitements sur mesure seront évalués sur demande. Le service clientèle est à votre disposition si vous avez besoin d'informations et de plus amples détails.

Verpackungshinweise. Alle geschneittenen einzelnen Teile werden nummeriert, wobei die Nummer des Teils auf der sichtbaren Seite eines Stücks Isolierband angebracht ist. Die Kartonverpackungen sind innen mit Polystyrol ausgelegt, um die Unversehrtheit der einzelnen Teile zu gewährleisten. Folgende Angaben befinden sich auf jedem Karton: Gesamtzahl der Teile Nummerierung jedes Teils. An der Palette sind eine Palettentarte und ein Kunststoffbeutel mit dem Montageplan angebracht. Für Anfragen von kleineren Formaten als vom Standard vorgesehen (120x240 oder 160x240) gilt der übliche Bearbeitungsvorgang für Sonderanfertigungen. N. B. Der Listenpreis bezieht sich auf die Dekoration im Standard-Format, einfarbig. Eventuelle kundenspezifische Verarbeitungen werden auf Anfrage kalkuliert. Der Kundenservice steht für weitere Informationen und Einzelheiten hierzu jederzeit zur Verfügung.

Notas sobre el embalaje. Todas las partes cortadas se enumeran colocando en la parte a la vista de la pieza una cinta adhesiva donde se reproduce el n.º de la pieza. El interior de las cajas se reviste con poliestireno para garantizar la integridad de cada una de las piezas. Sobre cada caja se reproduce: N.º de las piezas totales - Numeración de cada pieza. En la paleta se coloca una "pallet card" y una bolsa plástica que contiene el esquema del montaje. Para pedidos de formatos inferiores a los módulos de base (120x240 o 160x240), es necesario solicitar las elaboraciones no estándar. N. B. El precio de catálogo del decoro se refiere al formato estándar. Las elaboraciones a medida se evaluarán bajo pedido. El servicio de atención al cliente está a su disposición para proporcionarle más información y detalles al respecto.

Примечания по Упаковке. Каждый отдельный вырезанный элемент специально пронумерован с нанесением на лицевую поверхность куска изолянта с номером элемента. Коробки внутри полностью покрыты полистиролом для обеспечения целостности каждого отдельного элемента. На каждой из коробок указано: Общее количество элементов - Нумерация каждого из элементов. На поддон прикрепляется карточка паллеты и пластиковый пакет, содержащий схему монтажа. Запрос на форматы, меньше чем стандартные модули (120*240 или 160*240), рассматривается как запрос на изготовление нестандартных изделий. N. B. Цена прайс-листа отделочных материалов указана для стандартного формата, одноцветного и однослойного варианта. Цена на другие виды отделки сообщается по запросу. Центр обслуживания клиентов всегда готов предоставить вам более подробную информацию и все интересующие вас детали.

Listino IMBALLI / Price List PACKAGING	
TIPO / TYPE	PREZZO / PRICE
A: CASSA / CRATE cm 175x340x31h - 68 ^{8/9"} x133 ^{6/7"} x12 ^{1/5"}	230,00 €
B: CASSA / CRATE cm 145x292x35h - 57 ^{1/11"} x115 ^{1/13"} x13 ^{7/9"}	160,00 €
C: CASSA / CRATE cm 136x263x34h - 53 ^{1/2"} x103 ^{1/2"} x13 ^{2/5"}	160,00 €
D: CASSA / CRATE cm 135x144x41h - 53 ^{1/7"} x56 ^{2/3"} x16 ^{1/7"}	-
E: CASSA / CRATE cm 135x144x66h - 53 ^{1/7"} x56 ^{2/3"} x26"	-
F: CASSA / CRATE cm 96x262x43h - 37 ^{4/5"} x103 ^{1/7"} x17"	160,00 €
G: CASSA / CRATE cm 174x183x41h - 68 ^{1/2"} x72 ^{1/17"}	160,00 €
H/I: CAVALLETTO / A-FRAME cm 73x330x200h - 28 ^{3/4"} x130 ^{3/4"} x78 ^{3/4"}	360,00 €
L: CAVALLETTO / A-FRAME cm 75x339x186h - 29 ^{1/2"} x133 ^{1/2"} x73 ^{2/9"}	500,00 €
M: CAVALLETTO / A-FRAME cm 75x290x146h - 29 ^{1/2"} x114 ^{1/6"} x57 ^{1/2"}	450,00 €
N/O: CAVALLETTO / A-FRAME cm 75x250x146h - 29 ^{1/2"} x98 ^{3/7"} x57 ^{1/2"}	380,00 €
P/Q: CAVALLETTO / A-FRAME cm 75x250x160h - 29 ^{1/2"} x98 ^{3/7"} x63"	280,00 €
R: CAVALLETTO / A-FRAME cm 75x170x195h - 29 ^{1/2"} x67 ^{1/6"} x76 ^{7/9"}	280,00 €

*Le lastre sono contenute in scatole da 2 pezzi ciascuna / Packing for this item is 2 slabs per box / Les plaques sont contenues dans des boîtes de 2 pièces chacune. Die Platten sind in Kartons zu je 2 Stück verpackt. / Las baldosas están empaquetadas en cajas de 2 piezas cada una / Данный материал упаковывается по 2 слэба в один ящик.

°per spedizioni >12 scatole / for shipments >12 boxes / pour les expéditions >12 boîtes / für Versandmengen >12 Schachteln / para envíos > 12 cajas / для отгрузок >12 коробок.

°per spedizioni ≤12 scatole / for shipments ≤12 boxes / pour les expéditions ≤12 boîtes / für Versandmengen ≤12 Schachteln / para envíos ≤12 cajas / для отгрузок ≤12 коробок.

TABELLA IMBALLI

PACKAGE TABLE/TABLEAU DE EMBALLAGES/TABELLE FORMATE/TABLA DE LOS EMBALAJES/Таблица упаковок

#6 SPESSORE / THICKNESS/ÉPAISSEUR/STÄRKE/ESPESOR/ТОЛЩИНА

TIPO TYPE	formato LASTRA SLAB size	LASTRA SLAB		CASSA vuota empty CRATE			CASSA piena full CRATE	CAVALLETTO vuoto empty A-Frame			CAVALLETTO pieno full A-Frame
		MQ	KG	PZ	MQ	KG	KG	PZ	MQ	KG	KG
	A 160x320 63"x126"	5,12	74,15	14	71,68	140,5	1178,6	-	-	-	-
	B 120x280 47 ^{1/4} "x110 ^{1/4} "	3,36	48,65	20	67,20	90,00	1063	-	-	-	-
	C 120x240 47 ^{1/4} "x94 ^{1/2} "	2,88	41,70	20	57,60	107,00	941	-	-	-	-
	D 120x120 47 ^{1/4} "x47 ^{1/4} "	1,44	20,85	24*	34,56	50,00	550	-	-	-	-
	E 6mm 120x120 47 ^{1/4} "x47 ^{1/4} "	1,44	20,70	48*	69,12	70	1065,1	-	-	-	-
	F 80x240 31 ^{1/2} "x94 ^{1/2} "	1,92	27,80	30	57,60	97,00	931	-	-	-	-
	G 160x160 63"x63"	2,56	37,06	24	61,44	45,00	934,44	-	-	-	-
	H 160x320 63"x126"	5,12	74,15	-	-	-	-	44	225,28	220,00	3482,6
	I 120x280 47 ^{1/4} "x110 ^{1/4} "	3,36	48,65	-	-	-	-	44	147,84	220,00	2360,6
	L 160x320 63"x126" Cavalletto in lamiera zincata Zinc-plated sheet A-frame	5,12	74,15	-	-	-	-	44	225,28	120,00	3382,6
	M 120x280 47 ^{1/4} "x110 ^{1/4} " Cavalletto in lamiera zincata Zinc-plated sheet A-frame	3,36	48,65	-	-	-	-	44	147,84	108,5	2249,1
	N 120x240 47 ^{1/4} "x94 ^{1/2} " Cavalletto in lamiera zincata Zinc-plated sheet A-frame	2,88	41,70	-	-	-	-	44	126,72	92,5	1941,5
	O 80x240 31 ^{1/2} "x94 ^{1/2} " Cavalletto in lamiera zincata Zinc-plated sheet A-frame	1,92	27,80	-	-	-	-	28	84,48	92,5	1325,5
	P 120x240 47 ^{1/4} "x94 ^{1/2} "	2,88	41,70	-	-	-	-	44	126,72	170,00	2004,8
	Q 80x240 31 ^{1/2} "x94 ^{1/2} "	1,92	27,80	-	-	-	-	44	84,48	170,00	1393,2
	R 160x160 63"x63"	2,56	37,07	-	-	-	-	44	112,64	160,00	1791,08

ESEMPI DI PERSONALIZZAZIONE DECORI IN DIMENSIONE 120X240

EXAMPLES OF DECORS CUSTOMIZATIONS 120X240 SIZE

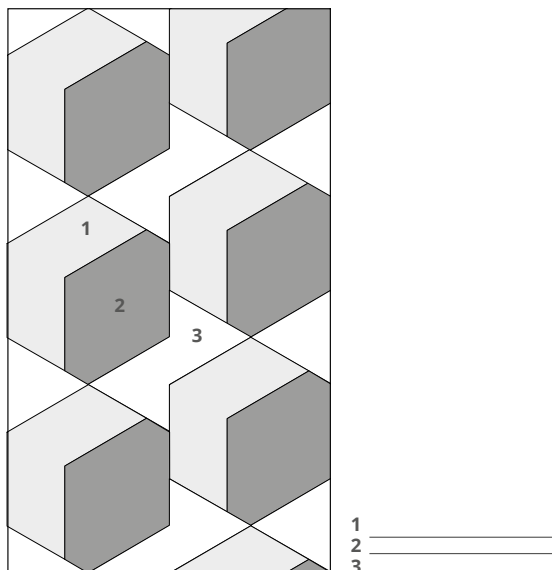

In ogni decoro è possibile selezionare materie e superfici combinandole nel modo in cui si desidera (vedi esempio).
Il decoro può essere adattato a qualsiasi misura richiesta.

For each decor you can select materials and surfaces combining them in the way you prefer (see example).
The decoration can be adapted to any requested measurements.

ABBINAMENTI CONSIGLIATI REX.

REX SUGGESTED COMBINATIONS.

I CLASSICI DI REX

MATIÈRES DE REX

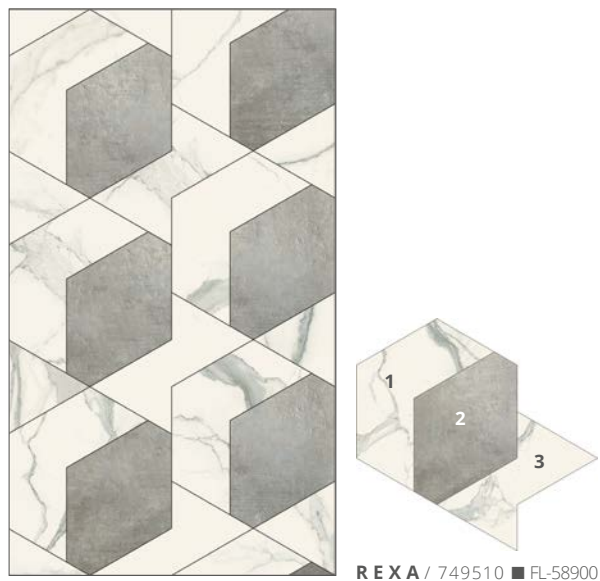

REX A / 749510 ■ FL-58900

1 / I CLASSICI DI REX / STATUARIO
2 / MATIÈRES DE REX / MATIÈRES NUAGE
3 / I CLASSICI DI REX / STATUARIO

ESEMPI DI PERSONALIZZAZIONE DECORI

EXAMPLES OF DECORS CUSTOMIZATIONS

PREXIOUS OF REX MATIÈRES DE REX



1/ PREXIOUS OF REX / DREAM ARABESQUE
2/ MATIÈRES DE REX / MATIÈRES MOU
3/ PREXIOUS OF REX / DREAM ARABESQUE

ÉTOILE DE REX MATIÈRES DE REX

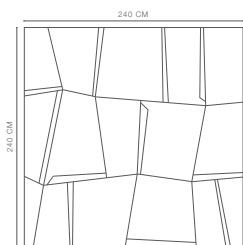

REXB / 749511 ■ FL-58900

1/ ÉTOILE DE REX / ÉTOILE SYMPHONIE
2/ MATIÈRES DE REX / MATIÈRES MOU

LES BIJOUX DE REX I CLASSICI DI REX

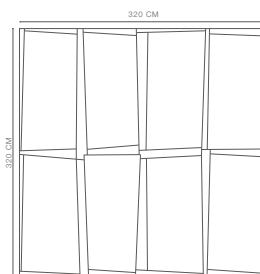

REXC / 749512 ■ FL-58900

1/ I CLASSICI DI REX / MARQUINIA
2/ LES BIJOUX DE REX / CALACATTA ALTISSIMO BLANC

ESEMPI DI PERSONALIZZAZIONE DECORI IN DIMENSIONE 120X240

EXAMPLES OF DECORS CUSTOMIZATIONS 120X240 SIZE

I CLASSICI DI REX

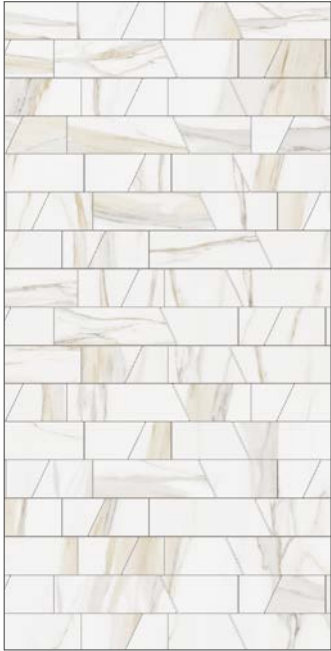

REXF / 749513 ■ FL-58900

I CLASSICI DI REX / CALACATTA GOLD

**LES BIJOUX DE REX
MATIÈRES DE REX**

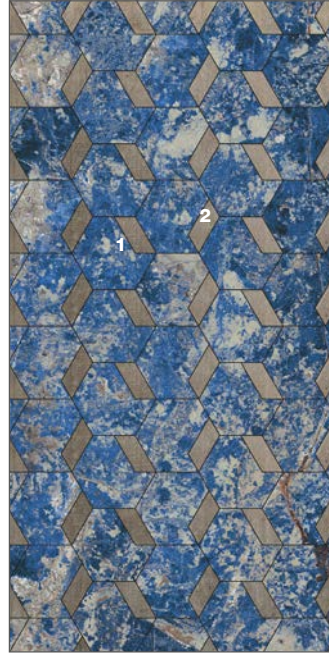

REXG / 749514 ■ FL-58900

**1/ LES BIJOUX DE REX / SODALITE BLEU
2/ MATIÈRES DE REX / MATIÈRES NUAGE**

ARDOISE



REXH / 749524 ■ FL-58900

**1/ ARDOISE / BLANC
2/ ARDOISE / ECRU
3/ ARDOISE / GRIS
4/ ARDOISE / NOIR**

I CLASSICI DI REX



REXI / 749525 ■ FL-58900

**1/ I CLASSICI DI REX / STATUARIO SOFT
2/ I CLASSICI DI REX / STATUARIO GLOSSY**

ESEMPI DI PERSONALIZZAZIONE DECORI IN DIMENSIONE 120X240

EXAMPLES OF DECORS CUSTOMIZATIONS 120X240 SIZE

RÊVES DE REX



REX L / 749526 ■ FL-58900

- 1/ RÊVES DE REX / RÊVE NOISETTE
- 2/ RÊVES DE REX / RÊVE NOISETTE
- 3/ RÊVES DE REX / RÊVE CHOCO
- 4/ RÊVES DE REX / RÊVE CHOCO

**RÊVES DE REX
I CLASSICI DI REX**

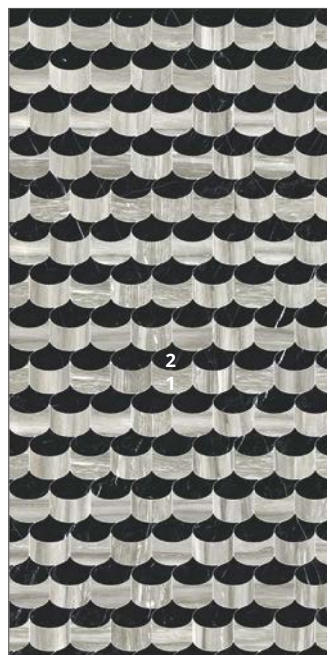

REX M / 749527 ■ FL-58900

- 1/ RÊVES DE REX / RÊVE BLEU GLOSSY
- 2/ I CLASSICI DI REX / MARQUINIA GLOSSY

MATIÈRES DE REX



REX O / 749530 ■ FL-58900

- 1/ MATIÈRES DE REX / MATIÈRES GRIS
- 2/ MATIÈRES DE REX / MATIÈRES NUAGE
- 3/ MATIÈRES DE REX / MATIÈRES SABLE

ESEMPI DI PERSONALIZZAZIONE DECORI IN DIMENSIONE 120X240

EXAMPLES OF DECORS CUSTOMIZATIONS 120X240 SIZE

LA ROCHE DI REX



1/ LA ROCHE DI REX / LA ROCHE BLANC
2/ LA ROCHE DI REX / LA ROCHE GREY



REXN / 749528 ■ FL-58900

PREXIOUS OF REX



1/ PREXIOUS OF REX / THUNDER NIGHT
2/ PREXIOUS OF REX / THUNDER NIGHT
3/ PREXIOUS OF REX / WHITE FANTASY
4/ PREXIOUS OF REX / WHITE FANTASY



REXP / 749529 ■ FL-58900

ESEMPI DI PERSONALIZZAZIONE DECORI IN DIMENSIONE 265X240

EXAMPLES OF DECORS CUSTOMIZATIONS 265X240 SIZE

I CLASSICI DI REX



I CLASSICI DI REX / CALACATTA GOLD

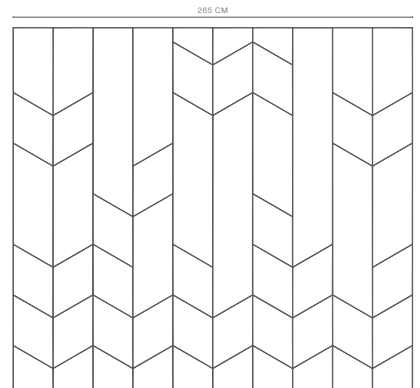

REXQ / 749531 ■ FL-58900

ESEMPI DI PERSONALIZZAZIONE DECORI

EXAMPLES OF DECORS CUSTOMIZATIONS

ARDOISE



REXE A/B/C / 750218 ■ FL-58900

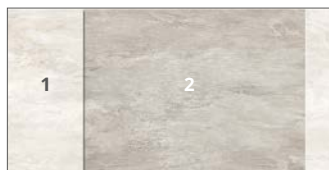

1 / ARDOISE / BLANC
2 / ARDOISE / GRIS



REXE A / 749515 ■ FL-58900



1 / ARDOISE / BLANC
2 / ARDOISE / GRIS



REXE B / 749516 ■ FL-58900

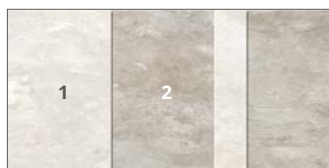

1 / ARDOISE / BLANC
2 / ARDOISE / GRIS

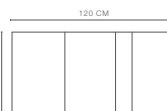

REXE C / 749517 ■ FL-58900

LA ROCHE DI REX



LA ROCHE DI REX / LA ROCHE ECRU



LA ROCHE DI REX / LA ROCHE ECRU

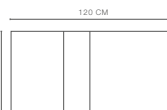

LA ROCHE DI REX / LA ROCHE ECRU

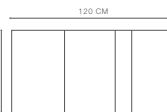

ESEMPI DI PERSONALIZZAZIONE DECORI IN DIMENSIONE 160X240

EXAMPLES OF DECORS CUSTOMIZATIONS 160X240 SIZE

MATIÈRES DE REX



REXD A/B/C/D/E/F / 750217
■ FL-58900

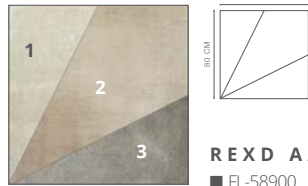

REXD A / 749518

■ FL-58900

- 1/ MATIÈRES DE REX / MATIÈRES SABLE
- 2/ MATIÈRES DE REX / MATIÈRES MOU
- 3/ MATIÈRES DE REX / MATIÈRES GRIS

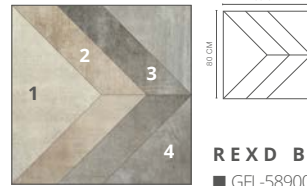

REXD B / 749519

■ GFL-58900

- 1/ MATIÈRES DE REX / MATIÈRES SABLE
- 2/ MATIÈRES DE REX / MATIÈRES MOU
- 3/ MATIÈRES DE REX / MATIÈRES GRIS
- 4/ MATIÈRES DE REX / MATIÈRES NUAGE

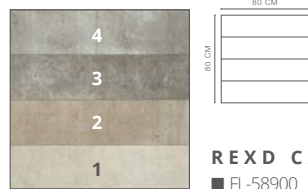

REXD C / 749520

■ FL-58900

- 1/ MATIÈRES DE REX / MATIÈRES SABLE
- 2/ MATIÈRES DE REX / MATIÈRES MOU
- 3/ MATIÈRES DE REX / MATIÈRES GRIS
- 4/ MATIÈRES DE REX / MATIÈRES NUAGE

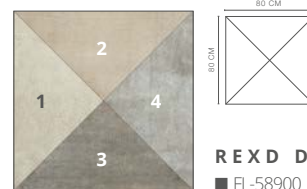

REXD D / 749521

■ FL-58900

- 1/ MATIÈRES DE REX / MATIÈRES SABLE
- 2/ MATIÈRES DE REX / MATIÈRES MOU
- 3/ MATIÈRES DE REX / MATIÈRES GRIS
- 4/ MATIÈRES DE REX / MATIÈRES NUAGE



REXD E / 749522

■ FL-58900

- 1/ MATIÈRES DE REX / MATIÈRES SABLE
- 2/ MATIÈRES DE REX / MATIÈRES MOU
- 3/ MATIÈRES DE REX / MATIÈRES GRIS
- 4/ MATIÈRES DE REX / MATIÈRES NUAGE

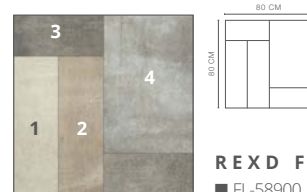

REXD F / 749523

■ FL-58900

- 1/ MATIÈRES DE REX / MATIÈRES SABLE
- 2/ MATIÈRES DE REX / MATIÈRES MOU
- 3/ MATIÈRES DE REX / MATIÈRES GRIS
- 4/ MATIÈRES DE REX / MATIÈRES NUAGE

FLORIM OVERSIZE
magnUm[®]

MODERN DESIGN
PERSPECTIVES ARE
CHANGING: AMAZING
SIZES IN A THICKNESS
OF JUST 6 MM,
LIGHT, VERSATILE
AND STRONG, WITH
EXTRAORDINARY
AESTHETIC APPEAL.

GRAPHICS

ARDOISE

BLANC



ECRU



GRIS



NOIR

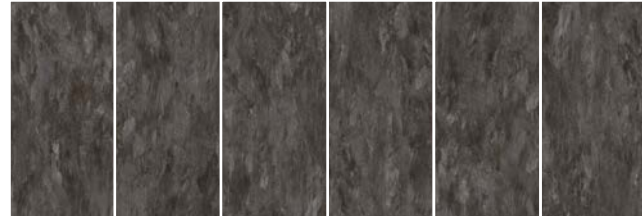

ÉTOILE DE REX

ÉTOILE RENNOIR



ÉTOILE GRIS



ÉTOILE CRÈME



ÉTOILE ILLUSION

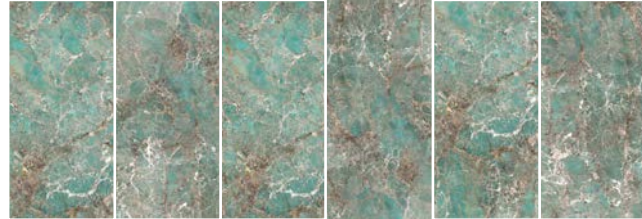

ÉTOILE SYMPHONIE



Le immagini riportate non rappresentano necessariamente il numero di grafiche del prodotto. Il numero di grafiche è variabile in funzione del formato e del colore di riferimento.
Images do not necessarily represent the number of patterns in the product's range. The number of different patterns varies according to size and color of the item. / Les images reportées ne représentent pas forcément le nombre de graphismes du produit. Leur nombre varie en fonction du format et de la couleur choisie. / Die Abbildungen geben keine bindende Auskunft bzgl. der Anzahl verschiedener Grafiken. Die Anzahl der Grafiken ist abhängig von Format und Farbe der jeweiligen Kollektion. / Las imágenes mostradas no representan necesariamente el número de gráficas del producto. El número de gráficas varía en función del formato y del color. / Представленные изображения необязательно обозначают количество графических вариаций «рубашек» материала. Количество изображений вариативно, зависит от формата и цвета продукта.

I CLASSICI DI REX

STATUARIO

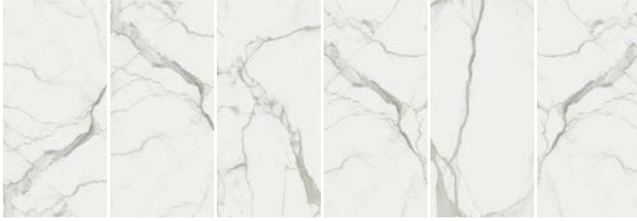

CALACATTA GOLD



MARQUINIA



LES ORIGINES DE REX

ORIGINES OR



ORIGINES ARGENT



ORIGINES BLANC

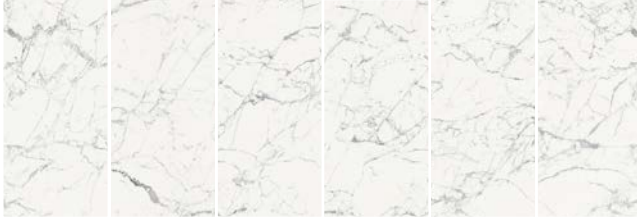

ORIGINES OMBRE DORÉE



RÊVES DE REX

RÊVE PERLE



RÊVE BLEU



RÊVE NOISETTE

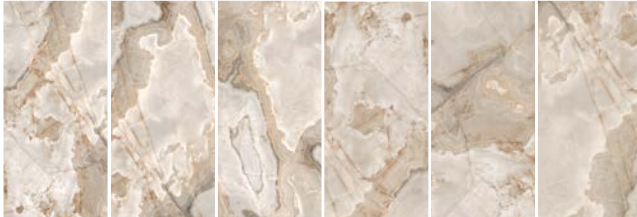

RÊVE CHOCO

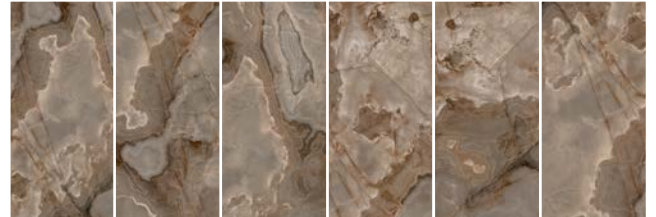

RÊVE ROSE



RÊVE JADE



PREXIOUS OF REX

WHITE FANTASY

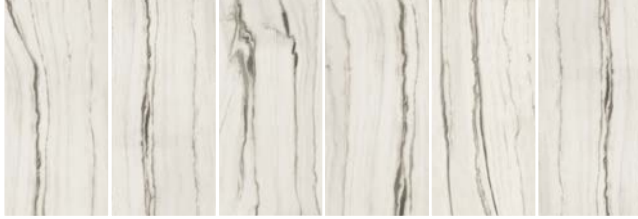

DREAM ARABESQUE



CHARMING AMBER

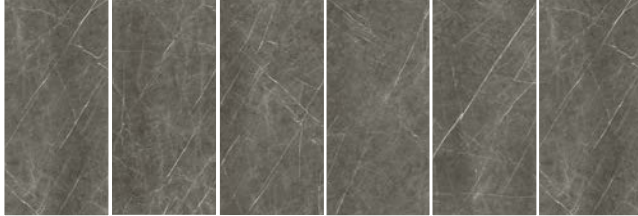

THUNDER NIGHT



LA ROCHE DI REX

LA ROCHE BLANC



LA ROCHE ECRU



LA ROCHE GREY



Le immagini riportate non rappresentano necessariamente il numero di grafiche del prodotto. Il numero di grafiche è variabile in funzione del formato e del colore di riferimento.
Images do not necessarily represent the number of patterns in the product's range. The number of different patterns varies according to size and color of the item. / Les images reportées ne représentent pas forcément le nombre de graphismes du produit. Leur nombre varie en fonction du format et de la couleur choisie. / Die Abbildungen geben keine bindende Auskunft bzgl. der Anzahl verschiedener Grafiken. Die Anzahl der Grafiken ist abhängig von Format und Farbe der jeweiligen Kollektion. / Las imágenes mostradas no representan necesariamente el número de gráficas del producto. El número de gráficas varía en función del formato y del color. / Представленные изображения необязательно обозначают количество графических вариаций «рубашек» материала. Количество изображений вариативно, зависит от формата и цвета продукта.

MATIÈRES DE REX

MATIÈRES SABLE



MATIÈRES NUAGE



MATIÈRES GRIS



MATIÈRES MOU



CALACATTA ALTISSIMO BLANC



ONYX BLANCHE



OMBRE DE CARAVAGE

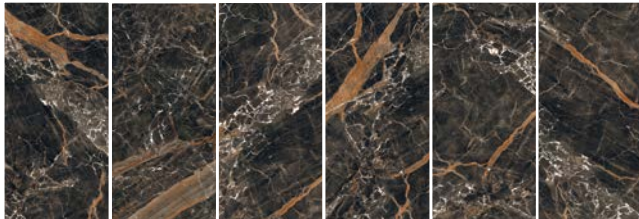

BRÈCHE CAPRAIA

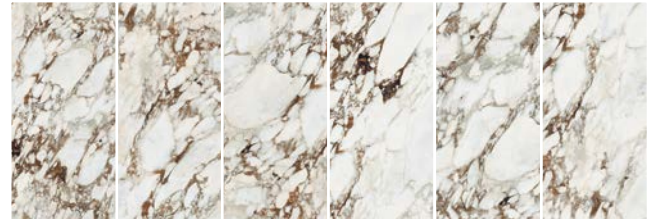

MARRON IMPERIAL

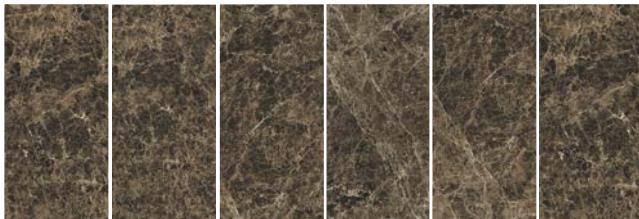

JASPE ROUGE



LES BIJOUX DE REX

SODALITE BLEU

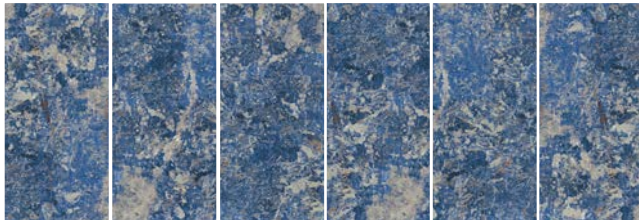

LES QUATRE SAISONS

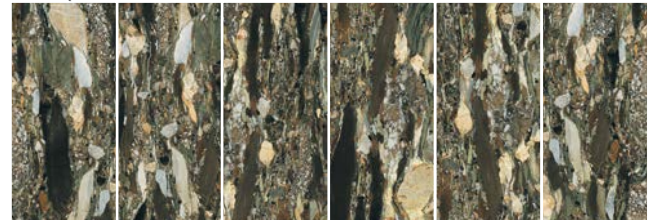

CARATTERISTICHE TECNICHE

TECHNICAL FEATURES
CARACTÉRISTIQUES TECHNIQUES
TECHNISCHE EIGENSCHAFTEN
CARACTERISTICAS TÉCNICAS
ТЕХНИЧЕСКИЕ ХАРАКТЕРИСТИКИ

6mm

LES ORIGINES DE REX - ÉTOILE DE REX - RÊVES DE REX

GRES PORCELLANATO COLORATO IN MASSA/SQUADRATO / COLOURED BODY PORCELAIN STONWARE/SQUARED
GRES CÉRAME COLORE DANS LA MASSE/QUARRI / DURCHGEFÄRBTE FEINSTEINZEUG/REKTIFIZIERT
GRES PORCELÁNICO COLOREADO EN MASA/ESCUADRADO / керамогранит, окрашенный по всей глицине/КАЛИБРОВАННАЯ

6 mm 1/4" ↑

CARATTERISTICHE TECNICHE - TECHNICAL CHARACTERISTICS - CARACTERÍSTICAS TÉCNICAS - TECHNISCHE EIGENSCHAFTEN - CARACTERÍSTICAS TÉCNICAS - технические характеристики				PRESCRIZIONE STANDARD REQUIREMENTS PRESCRIPTIONS ANFORDERUNGEN PRESCRIPTION TRESOBÄHNE N ≥ 15 cm		RISULTATI TESTS TEST RESULTS RESULTATS DES ESSAIS PRÜFERGEBNIS RESULTADOS TESTS РЕЗУЛЬТАТЫ ТЕСТОВ			RIFERIMENTO NORMA REFERENCE STANDARD STANDARDWERE REFERENCIA NORMA СТАНДАРТ
				(%)	(mm)	les origines de rex	étoile de rex	rêves de rex	
Piastrelle di ceramica pressate a secco. Caratteristiche di qualità secondo i test di controllo previsti dalla norma EN 14411-ISO 13006 Appendice G gruppo Bia GL / Dry-pressed ceramic tiles. Quality specifications, according to control tests of EN 14411-ISO 13006 Appendix G group Bia GL / Carreaux céramiques pressés à sec. Caractéristiques de qualité d'après les essais de contrôle norme EN 14411-ISO 13006 Appendice G groupe Bia GL / Trocken gepresste Keramikfliesen. / Qualitätseigenschaften nach Normen EN 14411-ISO 13006 Anhang G Gruppe Bia GL / Baldosas de cerámica rensadas en seco. Características de calidad según las Normas EN 14411-ISO 13006 Apéndice G grupo Bia GL. / Характеристики качества согласно контрольным тестам, предусмотренным нормой EN 14411-ISO 13006, приложение G группа Bia GL.				N ≥ 15 cm					
	LUNGHEZZA E LARGHEZZA: DEVIAZIONE AMMISSIBILE IN % DELLA DIMENSIONE MEDIA DI OGNI PIASTRELLA DALLA DIM. DI FABBRICAZIONE / LENGTH AND WIDTH: ADMITTED DEVIATION, IN % OF THE AVERAGE SIZE OF EACH TILE FROM THE PRODUCTION DIMENSIONS / LONGUEUR ET LARGEUR : MARGE DE TOLÉRANCE, EN % ENTRE LA DIMENSION MOYENNE DE CHAQUE CARREAU ET LA DIM. DE FABRICATION / LÄNGE UND BREITE: ZULÄSSIGE ABWEICHUNG DES DURCHSCHNITTMÄßES JEDER FLIESE VOM HERSTELLMÄß IN PROZENTEN / LARGO Y ANCHO: DESVIACIÓN ADMISIBLE, EN % DEL TAMAÑO MEDIO DE CADA BALDOSA A PARTIR DEL TAMAÑO DE FABRICACIÓN / Длина и ширина: допустимое отклонение в % среднего размера каждой плитки от производственных размеров	Squadrato ISO 13006	±0,3%	±1,0mm	±0,15%		ISO 10545-2		
	DEVIATIONE AMMISSIBILE, IN PERCENTO, DELLO SPESSORE MEDIO DI OGNI PIASTRELLA DALLA DIMENSIONE DI FABBRICAZIONE / ADMITTED DEVIATION, IN % OF THE AVERAGE THICKNESS OF EACH TILE FROM THE PRODUCTION DIMENSIONS / MARGE DE TOLÉRANCE, EN POURCENTAGE, ENTRE L'ÉPAISSEUR MOYENNE DE CHAQUE CARREAU ET LA DIMENSION DE FABRICATION / ZULÄSSIGE ABWEICHUNG DER DURCHSCHNITTSDICKE JEDER FLIESE VOM HERSTELLMÄß IN PROZENTEN / DESVIACIÓN ADMISIBLE, EN TANTO POR CIENTO, DEL GROSOR MEDIO DE CADA BALDOSA A PARTIR DEL TAMAÑO DE FABRICACIÓN / Допустимое отклонение в процентах средней толщины каждой плитки от производственных размеров		±5%	±0,5mm	±5%		ISO 10545-2		
	DEVIATIONE MASSIMA DI RETTILINEARITÀ, IN PERCENTO, IN RAPPORTO ALLE DIMENSIONI DI FABBRICAZIONE CORRISPONDENTI / MAXIMUM STRAIGHTNESS DEVIATION, IN %, IN RELATION TO THE CORRESPONDING PRODUCTION DIMENSIONS / MARGE DE TOLÉRANCE DE RECTITUDE, EN POURCENTAGE, PAR RAPPORT AUX DIMENSIONS DE FABRICATION CORRESPONDANTES / ZULÄSSIGE HOCHSTABWEICHUNG DER KANTENGERADHEIT IM VERHÄLTNIS ZU DEN ENTSPRECHENDEN HERSTELLMÄßEN IN PROZENTEN / DESVIACIÓN MÁXIMA DE RECTITUD, EN TANTO POR CIENTO, EN RELACIÓN CON EL TAMAÑO DE FABRICACIÓN CORRESPONDIENTE / Максимальное отклонение прямолинейности в процентах, пропорционально соответствующим производственным размерам	Squadrato ISO 13006	±0,3%	±0,8mm	±0,1%		ISO 10545-2		
	DEVIATIONE MASSIMA DI ORTOGONALITÀ, IN PERCENTO, IN RAPPORTO ALLE DIMENSIONI DI FABBRICAZIONE CORRISPONDENTI / MAXIMUM RIGHT-ANGLE DEVIATION, IN %, IN RELATION TO THE CORRESPONDING PRODUCTION DIMENSIONS / MARGE DE TOLÉRANCE D'ANGULARITÉ, EN POURCENTAGE, PAR RAPPORT AUX DIMENSIONS DE FABRICATION / HOCHSTABWEICHUNG DER RECHTHINKHEIT IM VERHÄLTNIS ZU DEN ENTSPRECHENDEN HERSTELLMÄßEN IN PROZENTEN / DESVIACIÓN MÁXIMA DE LA ORTOGONALIDAD, EN TANTO POR CIENTO, EN RELACIÓN CON EL TAMAÑO DE FABRICACIÓN CORRESPONDIENTE / Максимальное отклонение ортогональности в процентах, пропорционально соответствующим производственным размерам	Squadrato ISO 13006	±0,3%	±1,5mm	±0,2%		ISO 10545-2		
	PLANARITÀ (CURVATURA DEL CENTRO, DELLO SPIGOLLO E SVERGOLAMENTO) / FLATNESS (CURVING IN THE MIDDLE, CORNER AND WARPING) / PLANÉITÉ (COUBURE CENTRALE, DE L'ARÊTE ET GAUCHISSEMENT) / EBENFLÄCHIGKEIT (KRÜMMUNG DER MITTE, DER KANTE UND VERWINDUNGEN) / PLANITUD (CURVATURA DEL CENTRO, DE LA ARISTA Y ABRUJOLAMIENTO) / Плоскостность (изгиб центра, кромок и перекося)	Squadrato ISO 13006	±0,4%	±1,8mm	±0,2%		ISO 10545-2		
	QUALITÀ DELLA SUPERFICIE / SURFACE QUALITY / QUALITÉ DE LA SURFACE / QUALITÄT DER OBERFLÄCHE / CALIDAD DE LA SUPERFICIE / КАЧЕСТВА ПОВЕРХНОСТИ	Il 95% min delle piastrelle deve essere esente da difetti visibili. At least 95% of the tiles must be free from visible flaws. 95% min des carreaux ne doivent présenter aucun défaut visible. Mindestens 95% der Fliesen müssen frei von sichtbaren min. El 95% de las baldosas tiene que estar exento de defectos visibles min. 95% плитки не должны иметь видимых дефектов			CONFORME/CONFORMING CONFORME/KONFORM CONFORME /COOTBECTBYET			ISO 10545-2	
	MASSA D'ACQUA ASSORBITA IN % / % WATER ABSORPTION - MASSE D'EAU ABSORBÉE EN % WASSERAUFNÄHME IN % / MASA DE AGUA ABSORBIDA EN % / Поглощенная масса воды %		< 0,5%		valore medio 0,08%		ISO 10545-3		
	FORZA DI ROTTURA IN N (sp. < 7,5 mm) - BREAKING STRENGTH IN N (thickness < 7,5 mm) / FORCE DE RUPTURE EN N (p. < 7,5 mm) / BRUHLAST IN N (Dicke < 7,5 mm) / FUERZA DE ROTURA EN N (gr. < 7,5 mm) / Разрушающее усилие, Н (толщ. < 7,5 мм)		≥ 700		valore medio 1350 Newton		ISO 10545-4		
	RESISTENZA ALLA FLESSIONE IN N/mm ² / N/mm ² FLEXURAL STRENGTH TEST / RESISTENCIA A LA FLEXION EN N/mm ² / BIEGESTÄRKE IN N/mm ² / RESISTENCIA A LA FLECIÓN EN N/mm ² / Прочность при изгибе Н/мм ²		35 MIN.		valore medio 52 N/mm ²		ISO 10545-4		
	RESISTENZA ALL'ABRAZIONE DELLE PIASTRELLE SMALTATE / RESISTANCE TO ABRASION OF GLAZED TILES RESISTANCE A L'ABRASION DES CARREAUX ÉMALLÉS / TIEFENABRIEFESTIGKEIT GLASIERTER FLIESEN RESISTENCIA A LA ABRAZIONE DELS BALDOSAS ESMALTADAS / Стойкость к истиранию глазурированной плитки	come dichiarato dal produttore see manufacturer's declaration selon déclaration du producteur entsprechend der herstellerangaben tal como declara el fabricante КАК ЗАЯВЛЕНО ПРОИЗВОДИТЕЛЕМ			MATTE BLANC CLASSE 5 OR CLASSE 5 ARGENT CLASSE 4 O. DORÉE CLASSE 4 MATTE RENY CLASSE 2 CRÈME CLASSE 4 GRIS CLASSE 3 TROPICAL CLASSE 2 SYMPHONIE CLASSE 3 ILLUSION CLASSE 4 B. RIVER CLASSE 2 MATTE PERLE CLASSE 4 BLEU CLASSE 4 NOSETTE CLASSE 4 CHOCO CLASSE 3		ISO 10545-7		
					GLOSSY BLANC CLASSE 5 OR CLASSE 5 ARGENT CLASSE 4 O. DORÉE CLASSE 4 GLOSSY RENY CLASSE 2 CRÈME CLASSE 4 GRIS CLASSE 3 TROPICAL CLASSE 2 SYMPHONIE CLASSE 3 ILLUSION CLASSE 4 B. RIVER CLASSE 2 GLOSSY PERLE CLASSE 4 BLEU CLASSE 4 NOSETTE CLASSE 4 CHOCO CLASSE 2				
	RESISTENZA AGLI SBALZI TERMICI / THERMAL SHOCKS RESISTANT / RESISTANCE AUX VARIATIONS THERMIQUES / TEMPERATURWECHSELBESTÄNDIGKEIT / RESISTENCIA AL CHOQUE TÉRMICO / Стойкость к перепадам температуры	Metodo di prova disponibile / Available testing method Méthode d'essai disponible / Verfügbare Prüfmethode Método de ensayo disponible / Иметься метод испытания			RESISTE - RESISTANT RESISTE - ERFÜLLT RESISTE - УСТОЙЧИВ		ISO 10545-9		
	RESISTENZA AL GELO / FROST RESISTANCE RESISTANCE AU GEL / FROSTSTÄNDERHEIT RESISTENCIA A LA HELADA / УСТОЙЧИВОСТЬ К ХОЛОДУ	richiesta - required requise - gefordert requerida - ЭКПРОС			RESISTE - RESISTANT RESISTE - ERFÜLLT RESISTE - УСТОЙЧИВ		ISO 10545-12		
	RESISTENZA ALLE MACCHIE / RESISTANCE TO STAINING / RESISTANCE AUX TACHES FLECKENABWEISEND RESISTENCIA A LAS MANCHAS / ИСТОЙЧИВОСТЬ К ОБОЗНАЧЕНИЮ	Metodo di prova disponibile / Available testing method Méthode d'essai disponible / Verfügbare Prüfmethode Método de ensayo disponible / Иметься метод испытания			Classe 5 MATTE Classe 4 GLOSSY		Classe 5 MATTE Classe 4 GLOSSY		
	RILASCIO DI SOSTANZE PERICOLOSE / RELEASE OF HAZARDOUS SUBSTANCES / REJET DE SUBSTANCES DANGEREUSES / FREISETZUNG GEFÄHRLICHER STOFFE / LIBERACIÓN DE SUSTANCIAS PELIGROSAS / Выделение опасных веществ CADMIO (in mg/dm ²) - ПИОМБО (in mg/dm ²)	valore dichiarato per superfici GL con impieghi su piani di lavoro declared value for GL surfaces used on worktops valeur déclarée pour surfaces GL utilisées sur plans de travail angegebener wert für GL oberflächen zum gebrauch als arbeitsplatten valor declarado para acabados GL utilizados para superficies de trabajo Заявленное значение для глазурированных поверхностей, с использованием на рабочих столах			CONFORME/CONFORMING CONFORME/KONFORM CONFORME /COOTBECTBYET		DM-1-2-2007-Reg-CE-1935-2004		
	RESISTENZA A BASSE CONCENTRAZIONI DI ACIDI E ALCALI. / RESISTANCE TO LOW CONCENTRATIONS OF ACIDS AND ALKALIS. / RESISTANCE A BASSES CONCENTRATIONS D'ACIDES ET ALCALIS. / WIDERSTAND GEGEN NIEDRIGE KONZENTRATIONEN VON SAUREN UND LAUGEN. / RESISTENCIA A BAJAS CONCENTRACIONES DE ACIDOS Y ALCALIS. / Стойкость к кислотам и щелочам с низкой концентрацией.	come dichiarato dal produttore see manufacturer's declaration selon déclaration du producteur entsprechend der herstellerangaben tal como declara el fabricante КАК ЗАЯВЛЕНО ПРОИЗВОДИТЕЛЕМ			GLA MATTE GLB GLOSSY		GLA MATTE GLB GLOSSY		
	RESISTENZA AI PRODOTTI CHIMICI DI USO DOMESTICO E AGLI ADDITIVI PER PISCINA RESISTENCE TO DOMESTIC CHEMICAL PRODUCTS AND ADDITIVES FOR SWIMMING POOLS / RESISTANT AUX PRODUITS CHIMIQUES À USAGE DOMESTIQUE ET AUX ADDITIFS POUR PISCINE / WIDERSTAND GEGEN HAUSHALTSCHENIKALIEN UND / SCHWIMMBADDZUSATZMITTEL / RESISTENCIA A PRODUCTOS PARA LIMPIEZA DOMÉSTICA Y ADITIVOS PARA PISCINAS / Стойкость к бытовым химическим веществам и добавкам для бассейнов	MIN B			GA		ISO 10545-13		
	RESISTENZA AL CAVILLO DI PIASTRELLE SMALTATE / GLAZE CRAZING RESISTANCE - RESISTANCE AU TRESSAILLAGE POUR LES CARREAUX ÉMALLÉS / WIDERSTAND GEGEN HAARRISSE VON GLASIERTEN FLIESEN - RESISTENCIA AL CUARTREADO DE LOS AZULEJOS ESMALTADOS / Стойкость глазурированной плитки к образованию кракелюра	richiesta - required requise - gefordert requerida - ЗАПРОС			RESISTE - RESISTANT RESISTE - ERFÜLLT RESISTE - УСТОЙЧИВ		ISO 10545-11		
	COEFFICIENTE D'ATTIVO (SCIVOLOSITÀ) / FRICTION COEFFICIENT (SLIPPERINESS) / COEFFICIENT DE FRICTION (GLISSEMENT) / REIBKOEFFIZIENT (SCHLÜPFRIEGKEIT) - COEFICIENTE DE ANTI DESLIZAMIENTO / Коэффициент трения	-			>0,42 wet MATTE		>0,42 wet MATTE >0,42 wet MATTE		

Per un effetto ottimale della posa, florim suggerisce di mantenere 2 mm di fuga per pose monofornate e 3 mm per combinare formati misti / For optimal installation results, florim recommends maintaining a joint of 2 mm 1/12" for single format installations and 3 mm 1/8" to combine mixed formats / Pour réaliser une pose parfaite, florim suggère de maintenir 2 mm de joint pour la pose des monofornats, et 3 mm pour les combinaisons de formats mixtes / Um einen optimalen effekt beim verlegen zu erzielen empfehlt florim eine 2 mm fuge bei formatkombinationen / Para lograr un óptimo resultado en la posa del producto, florim aconseja 2 mm de junta en combinaciones de formatos mixtos / ЦЕЛ Я О П Т И М Ь Н О Ю И С К Л И К Ц И Я Ф Л О Р И М Ы С У Ж Е Н И Ь Н Ы Е Ф О Р М А Т Ь Н Ы Ы Х П Л И Т К

I CLASSICI DI REX - LES BIJOUX DE REX - PREVIOUS OF REX

6 mm 1/4" ↑↓

GRES PORCELLANATO COLORATO IN MASSA/SQUADRATO / COLOURED BODY PORCELAIN STONEWARE/SQUARED
 GRÉS CÉRAMÉ COLORE DANS LA MASSE/EQUARRI / DURCHGEFÄRBT FEINSTEINZEUG/REKTIFIZIERT
 GRES PORCELÁNICO COLOREADO EN MASA/ESCUADRADO / керамогранит, окрашенный по всей толщине/КАЛИБРОВАННАЯ

CARATTERISTICHE TECNICHE - TECHNICAL CHARACTERISTICS - CARACTERÍSTICAS TÉCNICAS - TECHNISCHE EIGENSCHAFTEN - CARACTERÍSTICAS TÉCNICAS - технические характеристики		PRESCRIZIONE STANDARD REQUIREMENTS PRESCRIPTIONS ANFORDERUNGEN PRESCRIPTION TRESBOAHME		RISULTATI TESTS TEST RESULTS RESULTATS DES ESSAIS PRÜFERERGEBNIS RESULTADOS TESTS РЕЗУЛЬТАТЫ ТЕСТОВ			RIFERIMENTO NORMA REFERENCE STANDARD REFERENCE NORME STANDARDWERT REFERENCE NORMA СТАНДАРТ
		N ≥ 15 cm		I CLASSICI DI REX	LES BIJOUX DE REX	PREVIOUS OF REX	
Piastrale di ceramica pressate a secco. Caratteristiche di qualità secondo i test di controllo previsti dalla norma EN 14411-ISO 13006 Appendice G gruppo Bla GL / Dry-pressed ceramic tiles. Quality specifications, according to control tests of EN 14411-ISO 13006 Appendix G group Bla GL / Carreaux céramiques pressés à sec. Caractéristiques de qualité d'après les essais de contrôle norme EN 14411-ISO 13006 Appendice G groupe Bla GL. / Trocken gepresste Keramikfliesen. / Qualitätsigenschaften nach Normen EN 14411-ISO 13006 Anhang G Gruppe Bla GL. / Baldosas de cerámica prensadas en seco. Características de calidad según las Normas EN 14411-ISO 13006 Apéndice G grupo Bla GL. / Характеристики качества согласно контрольным тестам, предусмотренным нормой EN 14411-ISO 13006, приложение G группа Bla GL.							
LUNGHEZZA E LARGHEZZA: DEVIAZIONE AMMISSIBILE, IN %, DELLA DIMENSIONE MEDIA DI OGNI PIASTRELLA DALLA DIM. DI FABBRICAZIONE / LENGTH AND WIDTH: ADMITTED DEVIATION, IN %, OF THE AVERAGE SIZE OF EACH TILE FROM THE PRODUCTION DIMENSIONS / LONGUEUR ET LARGEUR : MARGE DE TOLÉRANCE, EN %, ENTRE LA DIMENSION MOYENNE DE CHAQUE CARREAU ET LA DIM. DE FABRICATION / LÄNGE UND BREITE: ZULÄSSIGE ABWEICHUNG DES DURCHSCHNITTMES JEDER FLEISE VOM HERSTELLMAß IN PROZENTEN / LARGO Y ANCHO: DESVIACION ADMISIBLE, EN %, DEL TAMAÑO MEDIO DE CADA BALDOSA A PARTIR DEL TAMAÑO DE FABRICACIÓN / Длина и ширина: допустимое отклонение в % среднего размера каждой плитки от производственных размеров		Squadrato ISO 13006	±0,3%	±1,0mm		±0,15%	ISO 10545-2
DEVIATION AMMISSIBILE, IN PERCENTO, DELLO SPESORE MEDIO DI OGNI PIASTRELLA DALLA DIMENSIONE DI FABBRICAZIONE / ADMITTED DEVIATION, IN %, OF THE AVERAGE THICKNESS OF EACH TILE FROM THE PRODUCTION DIMENSIONS / MARGE DE TOLÉRANCE, EN POURCENTAGE, ENTRE L'ÉPAISSEUR MOYENNE DE CHAQUE CARREAU ET LA DIMENSION DE FABRICATION / ZULÄSSIGE ABWEICHUNG DER DURCHSCHNITTS DicKE JEDES FLEISE VOM HERSTELLMAß IN PROZENTEN / DESVIACION ADMISIBLE, EN TANTO POR CIENTO, DEL GROSOR MEDIO DE CADA BALDOSA A PARTIR DEL TAMAÑO DE FABRICACIÓN / Допустимое отклонение в процентах средней толщины каждой плитки от производственных размеров		-	±5%	±0,5mm		±5%	ISO 10545-2
DEVIATION MASSIMA DI RETTILINEARITÀ, IN PERCENTO, IN RAPPORTO ALLE DIMENSIONI DI FABBRICAZIONE CORRISPONDENTI / MAXIMUM STRAIGHTNESS DEVIATION, IN %, IN RELATION TO THE CORRESPONDING PRODUCTION DIMENSIONS / MARGE DE TOLÉRANCE DE RECTITUDE, EN POURCENTAGE, PAR RAPPORT AUX DIMENSIONS DE FABRICATION / CORRESPONDANTES / ZULÄSSIGE HOCHSTABWEICHUNG DER KANTENGERADHEIT IM VERHÄLTNIß ZU DEN ENTSPRECHENDEN HERSTELLMÄßEN IN PROZENTEN / DESVIACION MÁXIMA DE RECTITUD, EN TANTO POR CIENTO, EN RELACIÓN CON EL TAMAÑO DE FABRICACIÓN CORRESPONDIENTE / Максимальное отклонение прямолинейности в процентах, пропорционально соответствующим производственным размерам		Squadrato ISO 13006	±0,3%	±0,8mm		±0,1%	ISO 10545-2
DEVIATION MASSIMA DI ORTOGONALITÀ, IN PERCENTO, IN RAPPORTO ALLE DIMENSIONI DI FABBRICAZIONE CORRISPONDENTI / MAXIMUM RIGHT-ANGLE DEVIATION, IN %, IN RELATION TO THE CORRESPONDING PRODUCTION DIMENSIONS / MARGE DE TOLÉRANCE D'ANGLE, EN POURCENTAGE, PAR RAPPORT AUX DIMENSIONS DE FABRICATION / HOCHSTABWEICHUNG DER RECHTWINKELIGKEIT IM VERHÄLTNIß ZU DEN ENTSPRECHENDEN HERSTELLMÄßEN IN PROZENTEN / DESVIACION MÁXIMA DE LA ORTOGONALIDAD, EN TANTO POR CIENTO, EN RELACIÓN CON EL TAMAÑO DE FABRICACIÓN CORRESPONDIENTE / Максимальное отклонение ортогональности в процентах, пропорционально соответствующим производственным размерам		Squadrato ISO 13006	±0,3%	±1,5mm		±0,2%	ISO 10545-2
PLANARITÀ (CURVATURA DEL CENTRO, DELLO SPIGOLLO E SVERGOLAMENTO) / FLATNESS (CURVING IN THE MIDDLE, CORNER AND WARPING) / PLANÉTÉ (COURBURE CENTRALE, DE L'ARÊTE ET GAUCHISEMENT) / EBENFLÄCHIGKEIT (KRÜMMUNG DER MITTE, DER KANTE UND VERWINDUNG) / PLANITUD (CURVATURA DEL CENTRO, DE LA ARISTA Y ABAQUILLAMIENTO) / Плоскостность (изгиб центра, кромок и переко)		Squadrato ISO 13006	±0,4%	±1,8mm		±0,2%	ISO 10545-2
QUALITÀ DELLA SUPERFICIE / SURFACE QUALITY / QUALITÉ DE LA SURFACE / QUALITÄT DER OBERFLÄCHE / CALIDAD DE LA SUPERFICIE / КАЧЕСТВО ПОВЕРХНОСТИ		Il 95% min delle piastrelle deve essere esente da difetti visibili. At least 95% of the tiles must be free from visible flaws. 95% min des carreaux ne doivent présenter aucun défaut visible. Mindestens 95% der Fliesen müssen frei von sichtbaren min. El 95% de las baldosas tiene que estar exento de defectos visibles мин. 95% плитки не должны иметь видимых дефектов		CONFORME/CONFORMING CONFORME/KONFORM CONFORME /СОТВЕТСТВУЕТ			ISO 10545-2
MASSA D'ACQUA ASSORBITA IN % / WATER ABSORPTION - MASSE D'EAU ABSORBÉE EN % WASSERANNAHME IN % / MASA DE AGUA ABSORBIDA EN % / Поглощенная масса воды %		< 0,5%		valore medio 0,08%			ISO 10545-3
FORZA DI ROTTURA IN N (sp. < 7,5 mm) - BREAKING STRENGTH IN N (thickness < 7,5 mm) / FORCE DE RUPTURE EN N (é. < 7,5 mm) / BRUCHKRAFT IN N (Dicke < 7,5 mm) / FUERZA DE ROTURA EN N (gr. < 7,5 mm) / Разрушающее усилие, N (толщ. < 7,5 мм)		≥ 700		valore medio 1350 Newton			ISO 10545-4
RESISTENZA ALLA FLESSIONE IN N/mm2 / N/mm2 FLEXURAL STRENGTH TEST / RESISTANCE A LA FLEXION EN N/mm2 / BIEGESTÄRKE IN N/mm2 / RESISTENCIA A LA FLEXIÓN EN N/mm2 / Прочность при изгибе N/mm		35 MIN.		valore medio 52 N/mm2			ISO 10545-4
RESISTENZA ALL'ABRAZIONE DELLE PIASTRELLE SMALTATE / RESISTANCE TO ABRASION OF GLAZED TILES / RESISTANCE À L'ABRASION DES CARREAUX ÉMALLÉS / TIEFENABRIEFESTIGKEIT GLASIERTER FLIESEN / RESISTENCIA A LA ABRAS. DE LAS BALDOSAS ESMALTADAS / Стойкость к истиранию глазурированной плитки		come dichiarato dal produttore see manufacturer's declaration selon déclaration du producteur entsprechend der herstellangaben tal como declara el fabricante КАК ЗАЯВЛЕНО ПРОИЗВОДИТЕЛЕМ		STATUARIO CLASSE 4 CALCATA GOLD CLASSE 4 MARQUINA CLASSE 2	CALCATA ALT. BLANC CLASSE 4 ONYX BLANCHE CLASSE 5 BRECHE CARNAVA CLASSE 4 MARRON IMPERIAL CLASSE 2 OMBRE DE CARAVAGE (MATTÉ) LES QUATRE SAISONS CLASSE 2 JASPE ROUGE CLASSE 2 SODALITE BLEU CLASSE 2	MATTÉ D. ABRASION CLASSE 3 M. TRESAURE CLASSE 4 W. FANTASY CLASSE 4 CH. AMBER CLASSE 2 TH. NIGHT CLASSE 2 P. ATTRACTION CLASSE 3 GLOSSY D. ABRASION CLASSE 2 M. TRESAURE CLASSE 4 W. FANTASY CLASSE 4 CH. AMBER CLASSE 2 TH. NIGHT CLASSE 2 P. ATTRACTION CLASSE 2	ISO 10545-7
RESISTENZA AGLI SBALZI TERMICI / THERMAL SHOCKS RESISTANT / RESISTANCE AUX VARIATIONS THERMIQUES / TEMPERATURWECHSELBESTÄNDIGKEIT / RESISTENCIA AL CHOQUE TÉRMICO / Стойкость к перепадам температуры		Metodo di prova disponibile/Available testing method Méthode d'essai disponible/Verfügbare Prüfmethode Método de ensayo disponible/Используемый метод испытания		RESISTE - RÉSISTANT RESISTE - ERFÜLLT RESISTE - УСТОЙЧИВ			ISO 10545-9
RESISTENZA AL GELO / FROST RESISTANCE RESISTANCE AU GEL / FROSTSICHERHEIT RESISTENCIA A LA HELADA / УСТОЙЧИВОСТЬ К ХОЛОДУ		richesta - required requisit - gefordert requerida - ЭКПРОС		RESISTE - RÉSISTANT RESISTE - ERFÜLLT RESISTE - УСТОЙЧИВ			ISO 10545-12
RESISTENZA ALLE MACCHIE / RESISTANCE TO STAINING / RESISTANCE AUX TACHES / FLECKENABWEISEND / RESISTENCIA A LAS MANCHAS / устойчивость к образованию пятен		Metodo di prova disponibile Available testing method Méthode d'essai disponible Verfügbare Prüfmethode Método de ensayo disponible Используемый метод испытания		Classe 3-4			ISO 10545-14
RILASCIO DI SOSTANZE PERICOLOSE / RELEASE OF HAZARDOUS SUBSTANCES / REJET DE SUBSTANCES DANGEREUSES / FREISETZUNG GEFÄHRLICHER STOFFE / LIBERACIÓN DE SUSTANCIAS PELIGROSAS / Выделение опасных веществ CADMIO (in mg/dm ²) - PIOMBO (in mg/dm ²)		valore dichiarato per superfici GL con impieghi su piani di lavoro declared value for GL surfaces used on worktops valeur déclarée pour surfaces GL utilisées sur plans de travail angegebener wert für GL-oberflächen zum gebrauch als arbeitsplatten valor declarado para acabados GL utilizados para superficies de trabajo Заявленное значение для глазурированных поверхностей, с использованием на рабочих столах		CONFORME/CONFORMING CONFORME/KONFORM CONFORME /СОТВЕТСТВУЕТ			DM-1-2-2007-Reg-CE-1935-2004
RESISTENZA A BASSE CONCENTRAZIONI DI ACIDI E ALCALI / RESISTANCE TO LOW CONCENTRATIONS OF ACIDS AND ALKALIS / RESISTANCE A BASSES CONCENTRATIONS D'ACIDES ET ALCALIS / WIDERSTAND GEGEN NIEDRIGE KONZENTRATIONEN VON SÄUREN UND LAUGEN / RESISTENCIA A BAJAS CONCENTRACIONES DE ACIDOS Y ALCALIS / Стойкость к кислотам и щелочам с низкой концентрацией.		come dichiarato dal produttore see manufacturer's declaration selon déclaration du producteur entsprechend der herstellangaben tal como declara el fabricante КАК ЗАЯВЛЕНО ПРОИЗВОДИТЕЛЕМ		GLB			ISO 10545-13
RESISTENZA AI PRODOTTI CHIMICI DI USO DOMESTICO E AGLI ADDITIVI PER PISCINA RESISTENCE TO DOMESTIC CHEMICAL PRODUCTS AND ADDITIVES FOR SWIMMING POOLS / RESISTANT AUX PRODUITS CHIMIQUES À USAGE DOMESTIQUE ET AUX ADDITIFS POUR PISCINE / WIDERSTAND GEGEN HAUSHALTSCHIMIKALIEN UND / SCHWIMMBADZUSATZSTOFFEN / RESISTENCIA A PRODUCTOS PARA LIMPIEZA DOMESTICA Y ADITIVOS PARA PISCINAS / Стойкость к бытовым химическим веществам и добавкам для бассейнов		MIN B		GA			ISO 10545-11
RESISTENZA AL CAVILLO DI PIASTRELLE SMALTATE / GLAZE CRAZING RESISTANCE - RESISTANCE AU TRESSAILLAGE POUR LES CARREAUX ÉMALLÉS / WIDERSTAND GEGEN HAARRISS VON GLASIERTEN FLIESEN - RESISTENCIA AL CUARTEADO DE LOS AZULEJOS ESMALTADOS / Стойкость глазурированной плитки к образованию краquelera		richesta - required requisit - gefordert requerida - ЗАПРОС		RESISTE - RÉSISTANT RESISTE - ERFÜLLT RESISTE - УСТОЙЧИВ			ISO 10545-11
COEFFICIENTE D'ATTRITO (SCOLIVOLITÀ) / FRICTION COEFFICIENT (SLIPPERINESS) / COEFFICIENT DE FRICTION (GLISEMENT) / REIBUNGSKOEFFIZIENT (SCHLUPFRIGKEIT) / COEFICIENTE DE ANTI DESLIZAMIENTO / Коэффициент трения		-		>0,42 wet (MATTÉ)	>0,42 wet MARRON IMPERIAL (MATTÉ) OMBRE DE CARAVAGE (MATTÉ) SODALITE BLEU (MATTÉ) JASPE ROUGE (MATTÉ)	>0,42 wet (MATTÉ)	DCOF (section 9.6 ANSI A 137.1.2012)

Per un effetto ottimale della posa, florim suggerisce di mantenere 2 mm di fuga per pose monofornate e 3 mm per combinare formati misti / For optimal installation results, florim recommends maintaining a joint of 2 mm 1/16" for single format installations and 3 mm 1/8" to combine mixed formats / Pour réaliser une pose parfaite, florim suggère de maintenir 2 mm de joint pour la pose des monofornats, et 3 mm pour les combinaisons de formats mixtes / Um einen optimalen effekt beim verlegen zu erzielen empfehlt florim eine 2 mm fugе bei einfarbigen verlegungen und 3 mm fugе bei formatkombinationen / Para lograr los máximos resultados en la posa del producto, florim aconseja 2 mm de junta en aplicaciones monofornato y 3 mm en combinaciones de formatos mixtos / ЦЛЯ ОПТИМЛЬНОЙ УКЛАДКИ "florim" РЕКОМЕНДУЕТ НАДЕРЖИВАТЬ ШОС 2 ММ ЦЛЯ МОНОФОРМКИ И 3 ММ ПРИ СМЪЩЕННЫХ ФОРМКАХ.

ARDOISE - ESPRIT DE REX - LA ROCHE DI REX

GRES FINE PORCELLANATO/FINE PORCELAIN STONEWARE/GRES CERAME FIN/FEINSTEINZEUG-KOLLEKTIONEN/GRES PORCELANICO FINO/ФАРФОРОВЫЙ КЕРАМОГРАНИТ
SQUADRATO - SQUARED - EQUARRI - REKTIFIZIERT - ESQUADRADO - КАЛИБРОВАННАЯ

6 mm 1/4"







CARATTERISTICHE TECNICHE - TECHNICAL CHARACTERISTICS - CARACTERISTIQUES TECHNIQUES - TECHNISCHE EIGENSCHAFTEN - CARACTERÍSTICAS TÉCNICAS - технические характеристики							
	<p>Lastre in gres fine porcellanato non smaltato. Piastrelle di ceramica pressate a secco. Caratteristiche di qualità secondo i test di controllo previsti dalla norma EN 14411-ISO 13006 Appendice G gruppo B1a UGL. / Unglazed porcelain stoneware slabs. Drypressed ceramic tiles. Quality specifications, according to control tests of EN 14411-ISO 13006 Appendix G group B1a UGL. / Dalles en grés céramé fin non émaillé. Carreaux céramiques pressés à sec. Caractéristiques de qualité d'après les essais de contrôle norme EN 14411-ISO 13006 Appendice G groupe B1a UGL. / Nicht glasierte und vollständig gesinterete Feinsteinzeugplatten. Trocken gepresste Keramikfliesen. Qualitätseigenschaften nach Normen EN 14411-ISO 13006 Anhang G Gruppe B1a UGL. / Planchas de gres porcelánico fino no esmaltado. Baldosas de cerámica prensadas en seco. Características de calidad según las Normas EN 14411-ISO 13006 Appendix G grupo B1a UGL. / Плиты из неглазурированного фарфорового керамогранита. Керамическая плитка сухого прессования. Характеристики качества согласно контрольным тестам, предусмотренным нормой EN 14411-ISO 13006, приложение G группы B1a UGL.</p>	PRESCRIZIONE STANDARD REQUIREMENTS PRESCRIPTIONS ANFORDERUNGEN PRESCRIPTION ТРЕБОВАНИЕ		RISULTATI TESTS TEST RESULTS RESULTATS DES ESSAIS PRÜFERERGEBNIS RESULTADOS TESTES РЕЗУЛЬТАТЫ ТЕСТОВ			REFERIMENTO NORMA REFERENCE STANDARD RÉFÉRENCE NORME STANDARDWERT REFERENCIA NORMA СТАНДАРТ
		N ≥ 15 cm		N ≥ 15 cm			
		(%)	(mm)	ARDOISE	LA ROCHE DI REX	MATIÈRES DE REX	
	<p>LUNGHEZZA E LARGHEZZA: DEVIAZIONE AMMISSIBILE, IN % DELLA DIMENSIONE MEDIA DI OGNI PIASTRELLA DALLA DIM. DI FABBRICAZIONE / LENGTH AND WIDTH: ADMITTED DEVIATION, IN % OF THE AVERAGE SIZE OF EACH TILE FROM THE PRODUCTION DIMENSIONS / LONGUEUR ET LARGEUR, MARGE DE TOLÉRANCE EN % ENTRE LA DIMENSION MOYENNE DE CHAQUE CARREAU ET LA DIM. DE FABRICATION / LÄNGE UND BREITE: ZULÄSSIGE ABWEICHUNG DES DURCHSCHNITTMAßES JEDER FLIESE VOM HERSTELLMAß IN PROZENTEN / LARGO Y ANCHO: DESVIACIÓN ADMISIBLE, EN % DEL TAMAÑO MEDIO DE CADA BALDOSA A PARTIR DEL TAMAÑO DE FABRICACIÓN / Длина и ширина: допустимое отклонение в % среднего размера каждой плитки от производственных размеров</p>	Squadrato ISO 13006	±0,3%	±1,0mm	±0,15%		ISO 10545-2
	<p>DEVIAZIONE AMMISSIBILE, IN PERCENTO, DELLO SPESORE MEDIO DI OGNI PIASTRELLA DALLA DIMENSIONE DI FABBRICAZIONE / ADMITTED DEVIATION, IN %, OF THE AVERAGE THICKNESS OF EACH TILE FROM THE PRODUCTION DIMENSIONS / MARGE DE TOLÉRANCE, EN POURCENTAGE, ENTRE L'ÉPAISSEUR MOYENNE DE CHAQUE CARREAU ET LA DIMENSION DE FABRICATION / ZULÄSSIGE ABWEICHUNG DER DURCHSCHNITTSDICKE JEDER FLIESE VOM HERSTELLMAß IN PROZENTEN / DESVIACIÓN ADMISIBLE, EN TANPO POR CIENTO, DEL GROSOR MEDIO DE CADA BALDOSA A PARTIR DEL TAMAÑO DE FABRICACIÓN / Допустимое отклонение в процентах средней толщины каждой плитки от производственных размеров</p>	-	±5%	±0,5mm	±5%		ISO 10545-2
	<p>DEVIAZIONE MASSIMA DI RETTILINEARITÀ, IN PERCENTO, IN RAPPORTO ALLE DIMENSIONI DI FABBRICAZIONE CORRISPONDENTI / MAXIMUM STRAIGHTNESS DEVIATION, IN %, IN RELATION TO THE CORRESPONDING PRODUCTION DIMENSIONS / MARGE DE TOLÉRANCE DE RECTITUDE, EN POURCENTAGE, PAR RAPPORT AUX DIMENSIONS DE FABRICATION CORRÉSPONDANTES / ZULÄSSIGE HOCHSTABWEICHUNG DER HAUPTABMESSUNGEN IM VERHÄLTNIß ZU DEN ENTSPRECHENDEN HERSTELLMAßEN IN PROZENTEN / DESVIACIÓN MÁXIMA DE RECTITUD, EN TANPO POR CIENTO, EN RELACIÓN CON EL TAMAÑO DE FABRICACIÓN CORRÉSPONDIENTE / Максимальное отклонение прямолинейности в процентах, пропорционально соответствующим производственным размерам</p>	Squadrato ISO 13006	±0,3%	±0,8mm	±0,10%		ISO 10545-2
	<p>DEVIAZIONE MASSIMA DI ORTOGONALITÀ, IN PERCENTO, IN RAPPORTO ALLE DIMENSIONI DI FABBRICAZIONE CORRISPONDENTI MAXIMUM RIGHT-ANGLE DEVIATION, IN %, IN RELATION TO THE CORRESPONDING PRODUCTION DIMENSIONS / HOCHSTABWEICHUNG DER RECHTWINKLIGKEIT IM VERHÄLTNIß ZU DEN ENTSPRECHENDEN HERSTELLMAßEN IN PROZENTEN / DESVIACIÓN MÁXIMA DE LA ORTOGONALIDAD, EN TANPO POR CIENTO, EN RELACIÓN CON EL TAMAÑO DE FABRICACIÓN CORRÉSPONDIENTE / Максимальное отклонение ортогональности в процентах, пропорционально соответствующим производственным размерам</p>	Squadrato ISO 13006	±0,3%	±1,5mm	±0,2%		ISO 10545-2
	<p>PLANARITÀ (CURVATURA DEL CENTRO, DELLO SPIGOLO E SVERGLAMENTO) / FLATNESS (CURVING IN THE MIDDLE, CORNER AND WARPING PLAINTE (COUREUR CENTRALE, DE L'ARÊTE ET DE L'INCLÈSSEMENT) / EBENFLÄCHIGKEIT (KRÜMMUNG DER MITTE, DER KANTE UND VERWINDUNG) / PLANITUD (CURVATURA DEL CENTRO, DE LA ARISTA Y ABARQUILLAMIENTO) / Плоскостность (изгиб центра, кромок и перекоек)</p>	Squadrato ISO 13006	±0,4%	±1,8mm	±0,20%		ISO 10545-2
	<p>QUALITÀ DELLA SUPERFICIE / SURFACE QUALITY / QUALITÉ DE LA SURFACE / QUALITÄT DER OBERFLÄCHE CALIDAD DE LA SUPERFICIE / КАЧЕСТВА ПОВЕРХНОСТИ</p>				CONFORME/CONFORMING CONFORME/KONFORM CONFORME/ООТВЕТСТВУЕТ		ISO 10545-2
	<p>MASSA D'ACQUA ASSORBITA IN % / WATER ABSORPTION - MASSE D'EAU ABSORBÉE EN % / WASSERAUFNAHME IN % / MASA DE AGUA ABSORBIDA EN % / Поглощенная масса воды %</p>		< 0,5%		valore medio 0,08%		ISO 10545-3
	<p>FORZA DI ROTTURA IN N (sp. < 7,5 mm) - BREAKING STRENGTH IN N (thickness < 7,5 mm) / FORCE DE RUPTURE EN N (ép. < 7,5 mm) / BRUCHLAST IN N (Dicke < 7,5 mm) / FUERZA DE ROTURA EN N (gr. < 7,5 mm) / Разрушающее усилие, Н (толщ. < 7,5 мм)</p>		≥ 700		valore medio 1350 Newton		ISO 10545-4
	<p>RESISTENZA ALLA FLESSIONE IN N/mm² / FLEXURAL STRENGTH TEST / RÉSISTANCE À LA FLEXIÒN EN N/mm² / BIEGESTÄRKE IN N/mm² / RESISTENCIA A LA FLEXIÒN EN N/mm² / Прочность при изгибе Н/мм²</p>		35 MIN.		valore medio 52 N/mm ²		ISO 10545-4
	<p>RESISTENZA ALL'ABRAZIONE PROFONDA DELLE PIASTRELLE NON SMALTATE / RESISTANCE TO DEEP ABRASION OF UNGLAZED TILES / RESISTANCE À L'ABRASION PROFONDE DES CARREAUX NON ÉMAILLÉS / TIEFENABRIEFESTIGKEIT UNGLASIERTER FLIESEN / RESISTENCIA A LA ABRASIÒN PROFUNDA DE LAS BALDOSAS SIN ESMALTAR / Стойкость к глубокому истиранию неглазурированной плитки</p>		< 175 mm ³		valore medio 140 mm ³		ISO 10545-6
	<p>RESISTENZA AGLI SBALZI TERMICI / THERMAL SHOCKS RESISTANT / RÉSISTANCE AUX VARIATIONS THERMIQUES / TEMPERATURWECHSELBESTÄNDIGKEIT / RESISTENCIA AL CHOCQUE TÉRMICO / Стойкость к перепадам температуры</p>		Metodo di prova disponibile / Available testing method Méthode d'essai disponible / Verfügbare Prüfmethode Método de ensayo disponible Имещющийся метод испытания		RESISTE - RÉSISTANT RESISTE - ERFÜLLT RESISTE - УСТОЙЧИВ		ISO 10545-9
	<p>RESISTENZA AL GELO / FROST RESISTANCE RESISTANCE AU GEL / FROSTSTÄRKE RESISTENCIA A LA HELADA / УСТОЙЧИВОСТЬ К ХОЛОДУ</p>		RICHIESTA - REQUIRED REQUIS - GEFORDERT REQUERIDA - ЗАПРОС		RESISTE - RÉSISTANT RESISTE - ERFÜLLT RESISTE - УСТОЙЧИВ		ISO 10545-12
	<p>RESISTENZA ALLE MACCHIE / RESISTANCE TO STAINING / RÉSISTANCE AUX TACHES / FLECKENABWEISEND RESISTENCIA A LAS MANCHAS / ИСТОЙЧИВОСТЬ К ОБРАЗОВАНИЮ ПЯТЕН</p>		Metodo di prova disponibile / Available testing method Méthode d'essai disponible / Verfügbare Prüfmethode Método de ensayo disponible Имещющийся метод испытания	Classe 4	Classe 3-4	Classe 4-5	ISO 10545-14
Pb Cd	<p>RILASCIO DI SOSTANZE PERICOLOSE / RELEASE OF HAZARDOUS SUBSTANCES / REJET DE SUBSTANCES DANGEREUSES / FREISETZUNG GEFAHRLICHER STOFFE / LIBERACIÒN DE SUSTANCIAS PELIGROSAS / ВЫДЕЛЕНИЕ ОПАСНЫХ ВЕЩЕСТВ CADMIO (in mg/dm²) - ПИОМВО (in mg/dm²)</p>		VALORE DICHIARATO PER SUPERFICI GL CON IMPREGNI SU PIANI DI LAVORO / DECLARED VALUE FOR GL SURFACES USED ON WORKTOPS / VALEUR DÉCLARÉE POUR SURFACES GL UTILISÉES SUR PLANS DE TRAVAIL / ANGELEBENER WERT FÜR GL OBERFLÄCHEN ZUM GEBRAUCH ALS ARBEITSEBENE / WERTOR BEKLÄRTER PARA ACABADOS GL UTILIZADOS PARA SUPERFICIES DE TRABAJO / Заявленное значение для гладких поверхностей, с использованием на рабочих столах	CONFORME/CONFORMING CONFORME/KONFORM CONFORME/ООТВЕТСТВУЕТ			DM-1-2-2007-Reg-CE-1935-2004
	<p>RESISTENZA A BASSE CONCENTRAZIONI DI ACIDI E ALCALI / RESISTANCE TO LOW CONCENTRATIONS OF ACIDS AND ALKALIS / RESISTENCIA A BASSAS CONCENTRACIONES D'ACIDES Y ALCALIS / WIDERSTAND GEGEN NIEDRIGE KONZENTRATIONEN VON SAUREN UND LAUGEN / RESISTENCIA A BAJAS CONCENTRACIONES DE ACIDOS Y ALCALIS / Стойкость к кислотам и щелочам с низкой концентрацией.</p>		COME DICHIARATO DAL PRODUTTORE SEE MANUFACTURERS DECLARATION SELON DÉCLARATION DU PRODUCTEUR ENTSPRECHEND DER HERSTELLERANGABEN TAL COMO DECLARA EL FABRICANTE КАК ЗАЯВЛЕНО ПРОИЗВОДИТЕЛЕМ	ULA	ULB	ULA	ISO 10545-13
	<p>RESISTENZA A ALTE CONCENTRAZIONI DI ACIDI E ALCALI / RESISTANCE TO HIGH CONCENTRATIONS OF ACIDS/AND ALKALI / RESISTENCIA A DE HAUTES CONCENTRATIONS D'ACIDES ET BASES / BESTÄNDIGKEIT GEGEN STARK / KONZENTRIERTE SAUREN/UND LAUGEN / RESISTENCIA A ALTAS CONCENTRACIONES DE ACIDOS Y ALCALIS / Стойкость к высококонцентрированным кислотам и щелочам</p>			UHA	UHB	-	
	<p>RESISTENZA AI PRODOTTI CHIMICI DI USO DOMESTICO E AGLI ADDITIVI PER PISCINA / RESISTENCE TO DOMESTIC CHEMICAL PRODUCTS AND ADDITIVES FOR SWIMMING POOLS / RESISTANT AUX PRODUITS CHIMIQUES À USAGE DOMESTIQUE ET AUX ADDITIFS POUR PISCINE / WIDERSTAND GEGEN HAUSHALTS-CHEMIEALLEN UND / SCHWIMMBADANZUSATZSTOFFEN / RESISTENCIA A PRODUCTOS PARA LIMPIEZA DOMESTICA Y ADITIVOS PARA PISCINAS / Стойкость к бытовым химическим веществам и добавкам для бассейнов</p>			MIN B	UA		
				R9		R9 (matte) R10 (R+PTV)	DIN 51130
				-		CLASSE B (matte) CLASSE B (R+PTV)	DIN 51097
	<p>COEFFICIENTE D'ATTRITO (SCIVOLOSITÀ) / FRICTION COEFFICIENT (SLIPPERINESS) / COEFFICIENT DE FRICTION (GLISSEMENT) / REIBUNGSKOEFFIZIENT (SCHLUPFRIGKEIT) - COEFFICIENTE DE ANTI DESLIZAMIENTO / Коэффициент трения</p>			-		PTV> 36 wet slider 4S (R+PTV)	BS 7976
						> 0,42 wet	DCOF (section 9.6 ANSI A 137.1.2012)

Per un effetto ottimale della posa, florim suggerisce di mantenere 2 mm di fuga per pose monoformato e 3 mm per combinare formati misti. / For optimal installation results, florim recommends maintaining a joint of 2 mm 1/12" for single format installations and 3 mm 1/8" to combine mixed formats. / Pour réaliser une pose parfaite, florim suggère de maintenir 2 mm de joint pour la pose des monoformats, et 3 mm pour les combinaisons de formats mixtes / Um einen optimalen effekt beim verlegen zu erzielen empfohle florim eine 2 mm fuge bei einformatigen verlegungen und 3 mm fuge bei formatkombinationen / Para lograr los máximos resultados en la posa del producto, florim aconseja 2 mm de junta en aplicaciones monoformato y 3 mm en combinaciones de formatos mixtos / ЦІЯ ОПТИМІЙНОЇ УКЛАДКИ "florim" РЪКОМЪЩУЕТ НЕЦЬБРИНКТЪ СКЗОР 2 ММ ЦІЯ І 3 ММ ПРІ СМІШКНИХ ФОРМКТЪ.

I FILATI DI REX

GRÉS PORCELLANATO DÉCORATO
 DECORATED PORCELAIN TILES - GRÉS CÉRAMÉ DÉCORÉ - VERZIERTES FEINSTEINZEUG - GRÉS PORCELÁNICO DECORADO - ДЕКОРИРОВАННЫЙ КЕРАМОГРАНИТ
 SQUADRATO - SQUARED - EQUARRI - REKTIFIZIERT - ESQUADRADO - КАЛИБРОВАННАЯ

6 mm 1/4" 

CARATTERISTICHE TECNICHE - TECHNICAL CHARACTERISTICS - CARACTERISTIQUES TECHNIQUES - TECHNISCHE EIGENSCHAFTEN - CARACTERÍSTICAS TÉCNICAS - технические характеристики						
		PRESCRIZIONE STANDARD REQUIREMENTS PRESCRIPTIONS ANFORDERUNGEN PRESCRIPCION ТРЕБОВАНИЕ		RISULTATI TESTS TEST RESULTS RESULTATS DES ESSAIS PRÜFERGEBNIS RESULTADOS TESTS РЕЗУЛЬТАТЫ ТЕСТОВ	RIFERIMENTO NORMA REFERENCE STANDARD STANDARDWERT REFERENCIA NORMA СТАНДАРТ	
		N ≥ 15 cm (%) (mm)				
	LUNGHEZZA E LARGHEZZA: DEVIAZIONE AMMISSIBILE IN % DELLA DIMENSIONE MEDIA DI OGNI PIASTRELLA DALLA DIM. DI FABBRICAZIONE / LENGTH AND WIDTH: ADMITTED DEVIATION, IN %, OF THE AVERAGE SIZE OF EACH TILE FROM THE PRODUCTION DIMENSIONS / LONGUEUR ET LARGUEUR : MARGE DE TOLERANCE, EN %, ENTRE LA DIMENSION MOYENNE DE CHAQUE CARREAU ET LA DIM. DE FABRICATION / LANGE UND BREITE: ZULÄSSIGE ABWEICHUNG DES DURCHSCHNITTMARES JEDER FLIESE VOM HERSTELLMAß IN PROZENTEN / DESVIACION ADMISIBLE, EN DEL TAMAÑO MEDIO DE CADA BALDOSA A PARTIR DEL TAMAÑO DE FABRICACIÓN / Длина и ширина: допустимое отклонение в % среднего размера каждой плитки от производственных размеров	Squadrato ISO 13006	±0,3%	±1,0 mm	±0,15%	ISO 10545-2
	DEVIAZIONE AMMISSIBILE, IN PERCENTO, DELLO SPESSORE MEDIO DI OGNI PIASTRELLA DALLA DIMENSIONE DI FABBRICAZIONE / ADMITTED DEVIATION, IN %, OF THE AVERAGE THICKNESS OF EACH TILE FROM THE PRODUCTION DIMENSIONS / MARGE DE TOLERANCE, EN POURCENTAGE, ENTRE L'ÉPAISSEUR MOYENNE DE CHAQUE CARREAU ET LA DIMENSION DE FABRICATION / ZULÄSSIGE HOCHSTABWEICHUNG DER DURCHSCHNITTSDICKE JEDER FLIESE VOM HERSTELLMAß IN PROZENTEN / DESVIACION ADMISIBLE, EN TANTO POR CIENTO, DEL GROSOR MEDIO DE CADA BALDOSA A PARTIR DEL TAMAÑO DE FABRICACIÓN / Допустимое отклонение в процентах средней толщины каждой плитки от производственных размеров	-	±5%	±0,5 mm	±5%	ISO 10545-2
	DEVIAZIONE MASSIMA DI RETTILINEARITÀ, IN PERCENTO, IN RAPPORTO ALLE DIMENSIONI DI FABBRICAZIONE CORRISPONDENTI / MAXIMUM STRAIGHTNESS DEVIATION, IN %, IN RELATION TO THE CORRESPONDING PRODUCTION DIMENSIONS / MARGE DE TOLERANCE DE RECTITUDE, EN POURCENTAGE, PAR RAPPORT AUX DIMENSIONS DE FABRICATION - CORRESPONDANTES / ZULÄSSIGE HOCHSTABWEICHUNG DER KANTENGERADHEIT IM VERHÄLTNIS ZU DEN ENTSPRECHENDEN HERSTELLMAßEN IN PROZENTEN / DESVIACION MÁXIMA DE RECTITUD, EN TANTO POR CIENTO, EN RELACIÓN CON EL TAMAÑO DE FABRICACIÓN CORRESPONDIENTE / Максимальное отклонение прямолинейности в процентах, пропорционально соответствующим производственным размерам	Squadrato ISO 13006	±0,3%	±0,8 mm	±0,1%	ISO 10545-2
	DEVIAZIONE MASSIMA DI ORTOGONALITÀ, IN PERCENTO, IN RAPPORTO ALLE DIMENSIONI DI FABBRICAZIONE CORRISPONDENTI / MAXIMUM RIGHT-ANGLE DEVIATION, IN %, IN RELATION TO THE CORRESPONDING PRODUCTION DIMENSIONS / MARGE DE TOLERANCE D'ANGULARITÉ, EN POURCENTAGE, PAR RAPPORT AUX DIMENSIONS DE FABRICATION / HOCHSTABWEICHUNG DER RECHTWINKLIGKEIT IM VERHÄLTNIS ZU DEN ENTSPRECHENDEN HERSTELLMAßEN IN PROZENTEN / DESVIACION MÁXIMA DE LA ORTOGONALIDAD, EN TANTO POR CIENTO, EN RELACIÓN CON EL TAMAÑO DE FABRICACIÓN CORRESPONDIENTE / Максимальное отклонение ортогональности в процентах, пропорционально соответствующим производственным размерам	Squadrato ISO 13006	±0,3%	±1,5 mm	±0,2%	ISO 10545-2
	PLANARITÀ (CURVATURA DEL CENTRO, DELLO SPIGOLO E SVERGOLAMENTO) / FLATNESS (CURVING IN THE MIDDLE, CORNER AND WARPING) / PLANÉITÉ (COURBURE CENTRALE, DE L'ARÊTE ET GAUCHISSEMENT) / EBENFLÄCHIGKEIT (KRÜMMUNG DER MITTE, DER KANTE UND VERWINDUNG) / PLANITUD (CURVATURA DEL CENTRO, DE LA ARISTA Y ABARQUILLAMIENTO) / Плоскость (изгиб центра, кромок и переко)	Squadrato ISO 13006	±0,4%	±1,8 mm	±0,2%	ISO 10545-2
	QUALITÀ DELLA SUPERFICIE / SURFACE QUALITY / QUALITÉ DE LA SURFACE QUALITÄT DER OBERFLÄCHE / CALIDAD DE LA SUPERFICIE / КАЧЕСТВА ПОВЕРХНОСТИ		Il 95% min delle piastrelle deve essere esente da difetti visibili. At least 95% of the tiles must be free from visible flaws. 95% min des carreaux ne doivent présenter aucun défaut visible. Mindestens 95% der Fliesen müssen frei von sichtbaren min. El 95% de las baldosas tiene que estar exento de defectos visibles мин. 95% плитки не должны иметь видимых дефектов		CONFORME CONFORMING CONFORME KONFORM CONFORME СООТВЕТСТВЕТ	ISO 10545-2
	MASSA D'ACQUA ASSORBITA IN % / % WATER ABSORPTION / MASSE D'EAU ABSORBÉE EN % / WASSERAUFNAHME IN % / MASA DE AGUA ABSORBIDA EN % / Поглощенная масса воды %		< 0,5%		valore medio 0,08%	ISO 10545-3
	FORZA DI ROTTURA IN N (sp. < 7,5 mm) - BREAKING STRENGTH IN N (thickness < 7,5 mm) / FORCE DE RUPTURE EN N (ép. < 7,5 mm) / BRUCHLAST IN N (Dicke < 7,5 mm) / FUERZA DE ROTURA EN N (gr. < 7,5 mm) / Разрушающее усилие, Н (толщ. < 7,5 мм)		≥ 700		valore medio 1350 N	ISO 10545-4
	RESISTENZA ALLA FLESSIONE IN N/mm ² / N/mm ² FLEXURAL STRENGTH TEST RESISTENCIA A LA FLEXIÓN EN N/mm / BIEGEFESTIGKEIT IN N/mm		35 MIN.		valore medio 52 N/mm ²	ISO 10545-4
	RESISTENZA ALLE MACCHIE / RESISTANCE TO STAINING / RÉSISTANCE AUX TACHES / FLECKE-NABWEISEND / RESISTENCIA A LAS MANCHAS / стойкость к образованию пятен		Metodo di prova disponibile Available testing method Méthode d'essai disponible Verfügbare Prüfmethode Método de ensayo disponible Имеющийся метод испытания		Classe 3-4	ISO 10545-14
	RESISTENZA AI PRODOTTI CHIMICI DI USO DOMESTICO E AGLI ADDITIVI PER PISCINA / RESISTENCE TO DOMESTIC CHEMICAL PRODUCTS AND ADDITIVES FOR SWIMMING POOLS / RÉSISTANT AUX PRODUITS CHIMIQUES À USAGE DOMESTIQUE ET AUX ADITIFS POUR PISCINE / WIDERSTAND GEGEN HAUSHALTSCHIMIKALIEN UND SCHWIMMBADZUSATZSTOFFEN / RESISTENCIA A PRODUCTOS PARA LIMPIEZA DOMESTICA Y ADITIVOS PARA PISCINAS / Стойкость к бытовым химическим веществам и добавкам для бассейнов		MIN B		B	ISO 10545-13
	REAZIONE AL FUOCO / FIRE - RESISTENCE / RÉACTION AU FEU / VERHALTEN IM BRANDFALL REACCIÓN AL FUEGO / ОГНЕСТОЙКОСТЬ		-		Classe B	UNI EN 13501:1 2009

Lastre decorate destinate esclusivamente al rivestimento di pareti interne./Decorated panels designed exclusively for tiling interior walls./ Dalles décorées, exclusivement destinées au revêtement de parois intérieures./ Verzierte Platten, ausschließlich zur Verkleidung von Innenwänden bestimmt./ Losas decoradas destinadas exclusivamente al revestimiento de paredes interiores./ Декорированная плитка больших размеров, предназначенная исключительно для внутренней облицовки стен.

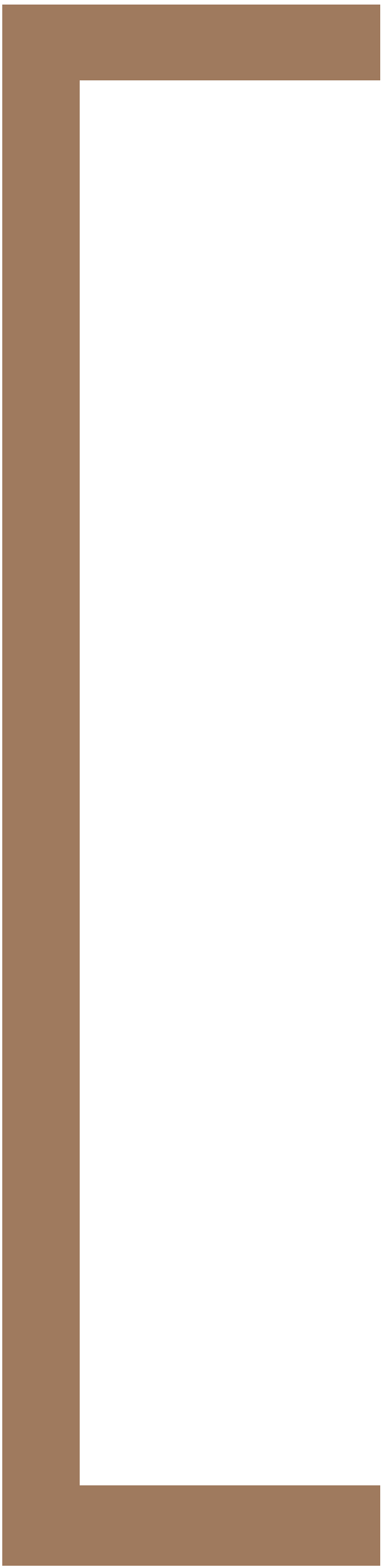











CARATTERISTICHE TECNICHE

TECHNICAL FEATURES
CARACTÉRISTIQUES TECHNIQUES
TECHNISCHE EIGENSCHAFTEN
CARACTERÍSTICAS TÉCNICAS
ТЕХНИЧЕСКИЕ ХАРАКТЕРИСТИКИ

10mm

GRES FINE PORCELLANATO
FINE PORCELAIN STONEWARE / GRÈS CÉRAME FIN / FEINSTEINZEUG - KOLLEKTIONEN / GRES PORCELÁNICO FINO / фарфорового керамогранита

CARATTERISTICHE TECNICHE - TECHNICAL CHARACTERISTICS - CARACTERÍSTICAS TÉCNICAS - TECHNISCHE EIGENSCHAFTEN - CARACTERÍSTICAS TÉCNICAS - технические характеристики

Lastre in gres fine porcellanato non smaltato. Piastrelle di ceramica pressate a secco. Caratteristiche di qualità secondo i test di controllo previsti dalla norma EN 14411-ISO 13006 Appendice G gruppo Bia UGL / Unglazed porcelain stoneware slabs. Dry-pressed ceramic tiles. Quality specifications, according to control tests of EN 14411-ISO 13006 Appendix G group Bia UGL / Dalles en grès cérame fin non émaillé. Carreaux céramiques pressés à sec. Caractéristiques de qualité d'après les essais de contrôle norme EN 14411-ISO 13006 Appendice G groupe Bia UGL / Nicht glasierte und vollständig gesinterter Feinsteinzeugplatten. Trocken gepresste Keramikfliesen. Qualitätsseigenschaften nach Normen EN 14411-ISO 13006 Anhang G Gruppe Bia UGL / Planchas de gres porcelánico fino no esmaltado. Baldosas de cerámica rensadas en seco. Características de calidad según las Normas EN 14411-ISO 13006 Apéndice G grupo Bia UGL / Плиты из неглазурованного фарфорового керамогранита.Керамическая плитка сухого прессования. Характеристики качества согласно контрольным тестам, предусмотренным нормой EN 14411-ISO 13006, приложение G группа Bia UGL.		PRESCRIZIONE STANDARD REQUIREMENTS PRESCRIPTIONS ANFORDERUNGEN PRESCRIZIONE ТРЕБОВАНИЕ		RISULTATI TESTS TEST RESULTS RESULTATS DES ESSAIS PRÜFERGEBNIS RESULTADOS TESTS РЕЗУЛЬТАТЫ ТЕСТОВ		RIFERIMENTO NORMA REFERENCE STANDARD RÉFÉRENCE NORME STANDARDEWERT REFERENCIA NORMA СТАНДАРТ	
		N ≥ 15 cm					
		(%)		(mm)			
■	LUNGHEZZA E LARGHEZZA: DEVIAZIONE AMMISSIBILE, IN %, DELLA DIMENSIONE MEDIA DI OGNI PIASTRELLA DALLA DIM. DI FABBRICAZIONE / LENGTH AND WIDTH: ADMITTED DEVIATION, IN %, OF THE AVERAGE SIZE OF EACH TILE FROM THE PRODUCTION DIMENSIONS / LONGUEUR ET LARGEUR : MARGE DE TOLÉRANCE, EN %, ENTRE LA DIMENSION MOYENNE DE CHAQUE CARREAU ET LA DIM. DE FABRICATION / LÄNGE UND BREITE: ZULÄSSIGE ABWEICHUNG DES DURCHSCHNITTMÄßES JEDER FLIESE VOM HERSTELLMAß IN PROZENTEN / LARGO Y ANCHO: DESVIACIÓN ADMISIBLE, EN %, DEL TAMAÑO MEDIO DE CADA BALDOSA A PARTIR DEL TAMAÑO DE FABRICACIÓN / Допустимое отклонение в % среднего размера каждой плитки от производственных размеров	Non squadrato EN 14411 - ISO 13006	±0,6%	±2,0mm	±0,6%	ISO 10545-2	
		Squadrato ISO 13006	±0,3%	±1,0mm	±0,15%		
	DEVIATIONE AMMISSIBILE, IN PERCENTO, DELLO SPESORE MEDIO DI OGNI PIASTRELLA DALLA DIMENSIONE DI FABBRICAZIONE / ADMITTED DEVIATION, IN %, OF THE AVERAGE THICKNESS OF EACH TILE FROM THE PRODUCTION DIMENSIONS / MARGE DE TOLÉRANCE, EN POURCENTAGE, ENTRE L'ÉPAISSEUR MOYENNE DE CHAQUE CARREAU ET LA DIMENSION DE FABRICATION / ZULÄSSIGE ABWEICHUNG DER DURCHSCHNITTSDICKE JEDER FLIESE VOM HERSTELLMAß IN PROZENTEN / DESVIACIÓN ADMISIBLE, EN %, DEL GROSOR MEDIO DE CADA BALDOSA A PARTIR DEL TAMAÑO DE FABRICACIÓN / Допустимое отклонение в процентах - средней толщины каждой плитки от производственных размеров	-	±5%	±0,5mm	±5%		
	DEVIATIONE MASSIMA DI RETTILINEARITÀ, IN PERCENTO, IN RAPPORTO ALLE DIMENSIONI DI FABBRICAZIONE CORRISPONDENTI / MAXIMUM STRAIGHTNESS DEVIATION, IN %, IN RELATION TO THE CORRESPONDING PRODUCTION DIMENSIONS / MARGE DE TOLÉRANCE DE RECTITUDE, EN POURCENTAGE, PAR RAPPORT AUX DIMENSIONS DE FABRICATION CORRESPONDANTES / ZULÄSSIGE HOCHSTABWEICHUNG DER KANTENGERADHEIT IM VERHÄLTNIS ZU DEN ENTSPRECHENDEN HERSTELLMÄßEN IN PROZENTEN / DESVIACIÓN MÁXIMA DE RECTITUD, EN TANTO POR CIENTO, EN RELACIÓN CON EL TAMAÑO DE FABRICACIÓN CORRESPONDIENTE / Максимальное отклонение прямолинейности в процентах, пропорционально соответствующим производственным размерам	Non squadrato EN 14411 - ISO 13006	±0,5%	±1,5mm	±0,5%		
		Squadrato ISO 13006	±0,3%	±0,8mm	±0,10%		
	DEVIATIONE MASSIMA DI ORTOGONALITÀ, IN PERCENTO, IN RAPPORTO ALLE DIMENSIONI DI FABBRICAZIONE CORRISPONDENTI / MAXIMUM RIGHT-ANGLE DEVIATION, IN %, IN RELATION TO THE CORRESPONDING PRODUCTION DIMENSIONS / MARGE DE TOLÉRANCE D'ANGULARITÉ, EN POURCENTAGE, PAR RAPPORT AUX DIMENSIONS DE FABRICATION / HOCHSTABWEICHUNG DER RECHTWINKLIGKEIT IM VERHÄLTNIS ZU DEN ENTSPRECHENDEN HERSTELLMÄßEN IN PROZENTEN / DESVIACIÓN MÁXIMA DE LA ORTOGONALIDAD, EN TANTO POR CIENTO, EN RELACIÓN CON EL TAMAÑO DE FABRICACIÓN CORRESPONDIENTE / Максимальное отклонение ортогональности в процентах, пропорционально соответствующим производственным размерам	Non squadrato EN 14411 - ISO 13006	±0,5%	±2,0mm	±0,5%		
	Squadrato ISO 13006	±0,3%	±1,5mm	±0,2%			
PLANARITÀ (CURVATURA DEL CENTRO, DELLO SPIGOLE E SVERGOLAMENTO) / FLATNESS (CURVING IN THE MIDDLE, CORNER AND WARPING) / PLANÉTÉ (COURBURE CENTRALE, DE L'ARÊTE ET GAUCHISSEMENT) / EBENFLÄCHIGKEIT (KRÜMMUNG DER MITTE, DER KANTE UND VERWINDUNG) / PLANITUD (CURVATURA DEL CENTRO, DE LA ARISTA Y ABARQUILLAMIENTO) / Плоскостность (изгиб центра, кромки и перекося)	Non squadrato EN 14411 - ISO 13006	±0,5%	±2,0 mm	±0,35%			
	Squadrato ISO 13006	±0,4%	±1,8 mm	±0,35%			
QUALITÀ DELLA SUPERFICIE - SURFACE QUALITY / QUALITÉ DE LA SURFACE - QUALITÄT DER OBERFLÄCHE / CALIDAD DE LA SUPERFICIE / КАЧЕСТВА ПОВЕРХНОСТИ	Il 95% min delle piastrelle deve essere esente da difetti visibili. / At least 95% of the tiles must be free from visible flaws. 95% min des carreaux ne doivent présenter aucun défaut visible. Mindestens 95% der Fliesen müssen frei von sichtbaren min. / el 95% de las baldosas tiene que estar exento de defectos visibles / мин. 95% плитки не должны иметь видимых дефектов		CONFORME/CONFORMING CONFORME/KONFORM CONFORME/COOTBETSVUET				
 MASSA D'ACQUA ASSORBITA IN % / % WATER ABSORPTION - MASSE D'EAU ABSORBÉE EN % / WASSERAUFNAHME IN % / MASA DE AGUA ABSORBIDA EN % / Поглощенная масса воды %			E<0,5%	valore medio 0,08%	ISO 10545-3		
 FORZA DI ROTTURA IN N (sp. ≥ 7,5 mm) - BREAKING STRENGTH IN N (thickness ≥ 7,5 mm) / FORCE DE RUPTURE EN N (ép. ≥ 7,5 mm) / BRUCHLAST IN N (Dicke ≥ 7,5 mm) / FUERZA DE ROTURA EN N (gr. ≥ 7,5 mm) / Разрушающее усилие, Н (толщ. ≥ 7,5 мм)			1300 min	valore medio 3200 N (spes. 10 mm) valore medio 14000 N (spes. 20 mm)	ISO 10545-4		
 RESISTENZA ALLA FLESSIONE IN N/mm ² / N/mm ² FLEXURAL STRENGTH TEST / RÉSISTANCE A LA FLEXION EN N/mm ² / BIEGESTÄRKE IN N/mm ² / RESISTENCIA A LA FLEXIÓN EN N/mm ² - Прочность при изгибе Н/мм			35 min	valore medio 50 N/mm ² (spes. 10 mm) valore medio 52 N/mm ² (spes. 20 mm)	ISO 10545-4		
 RESISTENZA ALL'ABRASIONE PROFONDA DELLE PIASTRELLE NON SMALTATE / RESISTANCE TO DEEP ABRASION OF UNGLAZED TILES / RÉSISTANCE À L'ABRASION PROFONDE DES CARREAUX NON ÉMAILLÉS / TIEFENABRIEBFESTIGKEIT UNGLASIERTER FLIESEN / RESISTENCIA A LA ABRASIÓN PROFUNDA DE LAS BALDOSAS SIN ESMALTAR / Стойкость к глубокому истиранию неглазурованной плитки			<175mm ³	valore medio 140mm ³	ISO 10545-6		
 RESISTENZA AGLI SBALZI TERMICI / THERMAL SHOCKS RESISTANT / RÉSISTANCE AUX VARIATIONS THERMIQUES / TEMPERATURWECHSELBESTÄNDIGKEIT / RESISTENCIA AL CHOQUE TÉRMICO / Стойкость к перепадам температуры			-	RESISTE - RÉSISTANT RÉSISTE - ERFÜLLT RESISTE - Стойкая	ISO 10545-9		
 RESISTENZA ALLE MACCHIE / RESISTANCE TO STAINING / RÉSISTANCE AUX TACHES / FLECKENABWEISEND / RESISTENCIA A LAS MANCHAS / нстойчивость к образованию пятен			-	≥ Classe 3	ISO 10545-14		
 RESISTENZA A BASSE CONCENTRAZIONI DI ACIDI E ALCALI / RESISTANCE TO LOW CONCENTRATIONS OF ACIDS AND ALKALIS. / RESISTANCE A BASSES CONCENTRATIONS D'ACIDES ET ALCALIS. / WIDERSTAND GEGEN NIEDRIGE KONZENTRATIONEN VON SAUREN UND LAUGEN. / RESISTENCIA A BAJAS CONCENTRACIONES DE ACIDOS Y ALCALIS. / Стойкость к кислотам и щелочам с низкой концентрацией.	COME DICHIARATO DAL PRODUTTORE SEE MANUFACTURERS DECLARATION SELON DÉCLARATION DU PRODUCTEUR ENTSPRECHEND DER HERSTELLERANGABEN TAL COMO DECLARA EL FABRICANTE Согласно заявлениям		vedere la serie - see the collection voir la collection - siehe der kollektion ver la coleccion - См. серию		ISO 10545-13		
 RESISTENZA A ALTE CONCENTRAZIONI DI ACIDI ED ALCALI / RESISTANCE TO HIGH CONCENTRATIONS OF ACIDS AND ALKALIS / RESISTANCE À HAUTES CONCENTRATIONS D'ACIDES ET BASES / BESTÄNDIGKEIT GEGEN STARK KONZENTRIERTE SAUREN UND LAUGEN / RESISTENCIA A ALTAS CONCENTRACIONES DE ACIDOS Y ALCALIS / Стойкость к высококонцентрированным кислотам и щелочам			vedere la serie - see the collection voir la collection - siehe der kollektion ver la coleccion - См. серию				
 RESISTENZA AI PRODOTTI CHIMICI DI USO DOMESTICO E AGLI ADDITIVI PER PISCINA / RESISTENCE TO DOMESTIC CHEMICAL PRODUCTS AND ADDITIVES FOR SWIMMING POOLS / RÉSISTANT AUX PRODUITS CHIMIQUES À USAGE DOMESTIQUE ET AUX ADDITIFS POUR PISCINE / WIDERSTAND GEGEN HAUSHALTSCHEMIEKALIEN UND SCHWIMMBADZUSATZSTOFFEN / RESISTENCIA A PRODUCTOS PARA LIMPIEZA DOMESTICA Y ADITIVOS PARA PISCINAS / Стойкость к бытовым химическим веществам и добавкам для бассейнов			UB min	UA			
 RESISTENZA AL GELO / FROST RESISTANCE - RÉSISTANCE AU GEL / FROSTSICHERHEIT - RESISTENCIA A LA HELADA / Морозостойкость			RICHIESTA / REQUIRED REQUISE / GEFORDET REQUERIDA / требуется	RESISTE - RÉSISTANT RÉSISTE - ERFÜLLT RESISTE - Стойкая	ISO 10545-12		
 COEFFICIENTE D'ATTRITO (SCIVOLosità) / FRICTION COEFFICIENT (SLIPPERINESS) / COEFFICIENT DE FRICTION (GLISSEMENT) / REIBUNGSKOEFFIZIENT (SCHLUPFRIGKEIT) - COEFICIENTE DE ANTI DESLIZAMIENTO / Коэффициент трения			-	vedere la serie - see the collection voir la collection - siehe der kollektion ver la coleccion - См. серию	-		

Per un effetto ottimale della posa, florim suggerisce di mantenere 2 mm di fuga per pose monoformato e 3 mm per combinare formati misti / For optimal installation results, florim recommends maintaining a joint of 2 mm 1/12" for single format installations and 3 mm 1/8" to combine mixed formats / Pour réaliser une pose parfaite, florim suggère de maintenir 2 mm de joint pour la pose des monoformats, et 3 mm pour les combinaisons de formats mixtes / Um einen optimalen effekt beim verlegen zu erzielen empfiehlt florim eine 2 mm fuge bei einformatigen verlegungen und 3 mm fuge bei formatkombinationen / Para lograr los máximos resultados en la posa del producto, florim aconseja 2 mm de junta en aplicaciones monoformato y 3 mm en combinaciones de formatos mixtos / ЦЛЯ ОПТИМЛЬНОЙ УКЛККИ "юним" РЪКОМЪНЦЪУЪТ НЫЦЪРЯИНКЪТ ЭКЗОР 2 ММ ЦЛЯ МОНОФОРМКТЪ И 3 ММ ПРИ СМЪШАННЫХЪ ФОРМКТЪ.

Per informazioni relative ai dati tecnici su marcatura CE vedere il sito www.florim.com / Please refer to our web site www.florim.com for technical information related to CE labeling / Pour tout renseignement sur l'avis technique de la marque CE veuillez consulter le site www.florim.com / Informationen bezüglich technischer Daten zur Beschriftung CE entnehmen Sie unserer Website www.rex-cerart.it / Para obtener más información y descargar las marcas CE: www.florim.com / Сведения по техническим данным маркировки CE можно найти на www.florim.com сайте









GRES PORCELLANATO COLORATO IN MASSA
COLOURED BODY PORCELAIN STONEWARE - GRÈS CÉRAME COLORE DANS LA MASSE - DURCHGEFÄRBT FEINSTEINZEUG/REKTIFIZIERT
GRES PORCELÁNICO COLOREADO EN MASA - керамогранит, окращенный по всей тлщине

CARATTERISTICHE TECNICHE - TECHNICAL CHARACTERISTICS - CARACTERISTIQUES TECHNIQUES - TECHNISCHE EIGENSCHAFTEN - CARACTERÍSTICAS TÉCNICAS - технические характеристики

	PIASTRELLE DI CERAMICA PRESSED A SECCO. CARATTERISTICHE DI QUALITÀ SECONDO I TEST DI CONTROLLO PREVISTI DALLA NORMA EN 14411-ISO 13006 APPENDICE G GRUPPO BLA GL / DRY-PRESSED CERAMIC TILES. QUALITY SPECIFICATIONS, ACCORDING TO CONTROL TESTS OF EN 14411-ISO 13006 APPENDIX G GROUP BLA GL / CARREAUX CÉRAMIQUES PRESSÉS À SEC. CARACTÉRISTIQUES DE QUALITÉ D'APRÈS LES ESSAIS DE CONTRÔLE NORME EN 14411-ISO 13006 APPENDICE G GROUPE BLA GL. / TROCKEN GEPRÉSSTE KERAMIKFLIESEN. / QUALITÄTSEIGENSCHAFTEN NACH NORMEN EN 14411-ISO 13006 ANHANG G GRUPPE BLA GL. / BALDOSAS DE CERÁMICA PENSADAS EN SECO. CARACTERÍSTICAS DE CALIDAD SEGÚN LAS NORMAS EN 14411-ISO 13006 APÉNDICE G GRUPO BLA GL. / Характеристики качества согласно контрольным тестам, предусмотренным нормой EN 14411-ISO 13006, приложение G группа BLA GL.	PRESCRIZIONE STANDARD REQUIREMENTS PRESCRIPTIONS ANFORDERUNGEN PRESCRIPTION ТРЕБОВАНИЕ		RISULTATI TESTS TEST RESULTS RESULTATS DES ESSAIS PRÜFERERGEBNIS RESULTADOS TESTS РЕЗУЛЬТАТЫ ТЕСТОВ	RIFERIMENTO NORMA REFERENCE STANDARD RÉFÉRENCE NORME STANDARDAWERT REFERENCIA NORMA СТАНДАРТ	
		N ≥ 15 cm				
		(%)	(mm)			
	LUNGHEZZA E LARGHEZZA-DEVIAZIONE AMMISSIBILE, IN % DELLA DIMENSIONE MEDIADIOGNIPIASTRELLADALLADIM. DI FABBRICAZIONE / LENGTH AND WIDTH: ADMITTED DEVIATION, IN % OF THE AVERAGE SIZE OF EACH TILE FROM THE PRODUCTION DIMENSIONS / LONGUEUR ET LARGEUR - MARGE DE TOLERANCE, EN %, ENTRE LA DIMENSION MOYENNE DE CHAQUE CARREAU ET LA DIM. DE FABRICATION / LÄNGE UND BREITE: ZULÄSSIGE ABWEICHUNG DES DURCHSCHNITTMÄßES JEDER FLIESE VOM HERSTELLMAß IN PROZENTEN / LARGO Y ANCHO: DESVIACION ADMISIBLE, EN %, DEL TAMAÑO MEDIO DE CADA BALDOSA A PARTIR DEL TAMAÑO DE FABRICACIÓN / Длина и ширина: допустимое отклонение в % среднего размера каждой плитки от производственных размеров	Non squadrato EN 14411 - ISO 13006	±0,6%	±2,0mm	±0,6%	
	Squadrato ISO 13006	±0,3%	±1,0mm	±0,15%		
	DEVIAZIONE AMMISSIBILE, IN PERCENTO, DELLO SPESORE MEDIO DI OGNI PIASTRELLA DALLA DIMENSIONE DI FABBRICAZIONE / ADMITTED DEVIATION, IN % OF THE AVERAGE THICKNESS OF EACH TILE FROM THE PRODUCTION DIMENSIONS / MARGE DE TOLERANCE, EN POURCENTAGE, ENTRE L'ÉPAISSEUR MOYENNE DE CHAQUE CARREAU ET LA DIMENSION DE FABRICATION / ZULÄSSIGE ABWEICHUNG DER DURCHSCHNITTSDICKE JEDER FLIESE VOM HERSTELLMAß IN PROZENTEN / DESVIACIÓN MÁXIMA DE RECTITUD, EN TANTO POR CIENTO, DEL GROSOR MEDIO DE CADA BALDOSA A PARTIR DEL TAMAÑO DE FABRICACIÓN / Допустимое отклонение в процента-средней толщины каждой плитки от производственных размеров	-	±5%	±0,5mm	±5%	
	DEVIAZIONE MASSIMA DI RETTILINEARITÀ, IN PERCENTO, IN RAPPORTO ALLE DIMENSIONI DI FABBRICAZIONE CORRESPONDENTI / MAXIMUM STRAIGHTNESS DEVIATION, IN %, IN RELATION TO THE CORRESPONDING PRODUCTION DIMENSIONS / MARGE DE TOLERANCE DE RECTITUDE, EN POURCENTAGE, PAR RAPPORT AUX DIMENSIONS DE FABRICATION CORRESPONDANTES / ZULÄSSIGE HÖCHSTABWEICHUNG DER KANTENGERADHEIT IM VERHÄLTNISS ZU DEN ENTSPRECHENDEN HERSTELLMAßEN IN PROZENTEN / DESVIACIÓN MÁXIMA DE RECTITUD, EN TANTO POR CIENTO, EN RELACIÓN CON EL TAMAÑO DE FABRICACIÓN CORRESPONDIENTE / Максимальное отклонение прямолинейности в процентах, пропорционально соответствующим производственным размерам	Non squadrato EN 14411 - ISO 13006	±0,5%	±1,5mm	±0,5%	ISO 10545-2
	Squadrato ISO 13006	±0,3%	±0,8mm	±0,10%		
	DEVIAZIONE MASSIMA DI ORTOGONALITÀ, IN PERCENTO, IN RAPPORTO ALLE DIMENSIONI DI FABBRICAZIONE CORRESPONDENTI / MAXIMUM RIGHT-ANGLE DEVIATION, IN %, IN RELATION TO THE CORRESPONDING PRODUCTION DIMENSIONS / MARGE DE TOLERANCE D'ANGULARITÉ, EN POURCENTAGE, PAR RAPPORT AUX DIMENSIONS DE FABRICATION / HÖCHSTABWEICHUNG DER RECHTWINKLIGKEIT IM VERHÄLTNISS ZU DEN ENTSPRECHENDEN HERSTELLMAßEN IN PROZENTEN / DESVIACIÓN MÁXIMA DE LA ORTOGONALIDAD, EN TANTO POR CIENTO, EN RELACIÓN CON EL TAMAÑO DE FABRICACIÓN CORRESPONDIENTE / Максимальное отклонение ортогональности в процентах, пропорционально соответствующим производственным размерам	Non squadrato EN 14411 - ISO 13006	±0,5%	±2,0mm	±0,5%	
	Squadrato ISO 13006	±0,3%	±1,5mm	±0,2%		
	PLANARITÀ (CURVATURA DEL CENTRO, DELLO SPIGOLO E SVERGOLAMENTO) / FLATNESS (CURVING IN THE MIDDLE, CORNER AND WRAPING) / PLANÉTIE (COUBREURIE, CENTRE, DE L'ARÊTE ET GAUCHISSEMENT) / EBENFLÄCHIGKEIT (KÜRMMUNG DER MITTE, DER KANTE UND VERWINDUNG) / PLANITUD (KURVATURA DEL CENTRO, DE LA ARISTA Y ABARQUILLAMIENTO) / Плоскостность (изгиб центра, кромок и перекос)	Non squadrato EN 14411 - ISO 13006	±0,5%	±2,0mm	±0,35%	
	Squadrato ISO 13006	±0,4%	±1,8mm	±0,35%		
	QUALITÀ DELLA SUPERFICIE - SURFACE QUALITY / QUALITÉ DE LA SURFACE - QUALITÄT DER OBERFLÄCHE / CALIDAD DE LA SUPERFICIE / КАЧЕСТВА ПОВЕРХНОСТИ	Il 95% min delle piastrelle deve essere esente da difetti visibili. / At least 95% of the tiles must be free from visible flaws. / 95% min des carreaux ne doivent présenter aucun défaut visible. Mindestens 95% der Fliesen müssen frei von sichtbaren min. / И 95% de las baldosas tiene que estar exento de defectos visibles / Мин. 95% плитки не должны иметь видимых дефектов		CONFORME/CONFORMING CONFORME/KONFORM CONFORME / СООТВЕТСТВУЕТ		
	MASSA D'ACQUA ASSORBITA IN % / WATER ABSORPTION - MASSE D'EAU ABSORBÉE EN % / WASSERAUFNAHME IN % / MASA DE AGUA ABSORBIDA EN % / Поглощенная масса воды %		E≤0,5%		valore medio 0,08 %	ISO 10545-3
	FORZA DI ROTTURA IN N (sp. ≥ 7,5 mm) - BREAKING STRENGTH IN N (thickness ≥ 7,5 mm) / FORCE DE RUPTURE EN N (ép. ≥ 7,5 mm) / BRUCHLAST IN N (Dicke ≥ 7,5 mm) / FUERZA DE ROTURA EN N (gr. ≥ 7,5 mm) / Разрушающее усилие, N (толщ. ≥ 7,5 мм)		1300 min		valore medio 3200 Newton	ISO 10545-4
	RESISTENZA ALLA FLESSIONE IN N/mm2 / FLEXION STRENGTH TEST / RÉSISTANCE A LA FLEXION EN N/mm2 / BIEGESTÄRKE IN N/mm / RESISTENCIA A LA FLEXIÓN EN N/mm / Прочность при изгибе Н/мм		35 min		valore medio 50 N/mm2	ISO 10545-4
	RESISTENZA ALL'ABRASIONE DELLE PIASTRELLE SMALTATE / RESISTANCE TO ABRASION OF GLAZED TILES / RESISTANCE A L'ABRASION DES CARREAUX ÉMAILLÉS / TIEFENABRIEBFESTIGKEIT GLASIERTER FLIESEN / RESISTENCIA A LA ABRASION DE LAS BALDOSAS ESMALTADAS / Стойкость к истиранию глазурованной плитки	COME DICHIARATO DAL PRODUTTORE SEE MANUFACTURER'S DECLARATION SELON DÉCLARATION DU PRODUCTEUR ENTSPRECHEND DER HERSTELLERANGABEN TAL COMO DECLARA EL FABRICANTE / Согласно заявлениям			vedere la serie - see the collection voir la collection - siehe der kollektion ver la coleccion - См. серию	ISO 10545-7
	RESISTENZA AGLI SBALZI TERMICI / THERMAL SHOCKS RESISTANT / RÉSISTANCE AUX VARIATIONS THERMIQUES / TEMPERATURWECHSELBESTÄNDIGKEIT / RESISTENCIA AL CHOQUE TÉRMICO / Стойкость к перепадам температуры		-		RESISTE - RÉSISTANT RÉSISTE - ERFÜLLT RESISTE - Стойкая	ISO 10545-9
	RESISTENZA ALLE MACCHIE / RESISTANCE TO STAINING / RÉSISTANCE AUX TACHES / FLECKENABWEISEND / RESISTENCIA A LAS MANCHAS / стойкость к образованию пятен		Classe 3 min		≥ Classe 3	ISO 10545-14
	RESISTENZA A BASSE CONCENTRAZIONI DI ACIDI E ALCALI / RESISTANCE TO LOW CONCENTRATIONS OF ACIDS AND ALKALIS / RESISTANCE A BASSES CONCENTRATIONS D'ACIDES ET ALCALIS / WIDERSTAND GEGEN NIEDRIGE KONZENTRATIONEN VON SAUREN UND LAUSEN / RESISTENCIA A BAJAS CONCENTRACIONES DE ACIDOS Y ALCALIS / Стойкость к кислотам и щелочам с низкой концентрацией	COME DICHIARATO DAL PRODUTTORE SEE MANUFACTURER'S DECLARATION SELON DÉCLARATION DU PRODUCTEUR ENTSPRECHEND DER HERSTELLERANGABEN TAL COMO DECLARA EL FABRICANTE / Согласно заявлениям			vedere la serie - see the collection voir la collection - siehe der kollektion ver la coleccion - См. серию	ISO 10545-13
	RESISTENZA AI PRODOTTI CHIMICI DI USO DOMESTICO E AGLI ADDITIVI PER PISCINA / RESISTENCE TO DOMESTIC CHEMICAL PRODUCTS AND ADDITIVES FOR SWIMMING POOLS / RÉSISTANT AUX PRODUITS CHIMIQUES À USAGE DOMESTIQUE ET AUX ADDITIFS POUR PISCINE / WIDERSTAND GEGEN HAUSHALTS-CHEMIKALIEN UND SCHWIMMBADZUSATZSTOFFEN / RESISTENCIA A PRODUCTOS PARA LIMPIEZA DOMESTICA Y ADITIVOS PARA PISCINAS / Стойкость к бытовым химическим веществам и добавкам для бассейнов		GB min		GA	
	RESISTENZA AL GELO / FROST RESISTANCE - RÉSISTANCE AU GEL / FROSTSICHERHEIT - RESISTENCIA A LA HELADA / Морозостойкость		RICHIESTA / REQUIRED REQUISE / GEFORDET REQUERIDA / кребується		RÉSISTE - RÉSISTANT RÉSISTE - ERFÜLLT RESISTE - Стойкая	ISO 10545-12
	RESISTENZA AL CAVILLO DI PIASTRELLE SMALTATE / GLAZE CRAZING RESISTANCE - RÉSISTANCE AU TRESSAILLAGE POUR LES CARREAUX ÉMAILLÉS / WIDERSTAND GEGEN HAARRIS VON GLASIERTEN FLIESEN - RESISTENCIA AL CUARTEADO DE LOS AZULEJOS ESMALTADOS / Стойкость глазурованной плитки к образованию кракелюра		RICHIESTA / REQUIRED REQUISE / GEFORDET REQUERIDA / кребується		RÉSISTE - RÉSISTANT RÉSISTE - ERFÜLLT RESISTE - Стойкая	ISO 10545-11
	COEFFICIENTE D'ATTRITO (SCIVOLosità) / FRICTION COEFFICIENT (SLIPPERINESS) / COEFFICIENT DE FRICTION (GLISSEMENT) / REIBUNGSKOEFFIZIENT (SCHLÜPFRIEGKEIT) - COEFICIENTE DE ANTI DESLIZAMIENTO / Коэффициент трения		-		vedere la serie - see the collection voir la collection - siehe der kollektion ver la coleccion - См. серию	-

Per un effetto ottimale della posa, Forim suggerisce di mantenere 2 mm di fuga per pose monofornate e 3 mm per combinare formati misti. / For optimal installation results, Forim recommends maintaining a joint of 2 mm 1/12" for single format installations and 3 mm 1/8" to combine mixed formats. / Pour réaliser une pose parfaite, Forim suggère de maintenir 2 mm de joint pour les combinaisons de formats mixtes. / Um einen optimalen Verlegungs zu erzielen, empfiehlt Forim eine 2 mm fuga bei einformatigen Verlegungen und 3 mm fuga bei formatkombinationen. / Para lograr los máximos resultados en la posa del producto, Forim aconseja 2 mm de junta en aplicaciones monofornata y 3 mm en combinaciones de formatos mixtos. / ЦЛЯ ОПТИМЛЬНОЙ УКЛАДКИ "юрим" РЪКОМЪНЦЪТЪ НИЦЪРЯИНЪТЪ ЭКЗОР 2 ММ ЦЛЯ МОНОФОРМТК И 3 ММ ПРИ СМЪШАННЫХ ФОРМТК.

Per informazioni relative ai dati tecnici su marcatura CE vedere il sito www.forim.com / Please refer to our web site www.forim.com for technical information related to CE labeling. / Pour tout renseignement sur l'avis technique de la marque CE veuillez consulter le site www.forim.com / Informationen bezüglich technischer Daten zur Beschriftung CE entnehmen Sie unserer Website www.rex-cerart.it / Para obtener más información y descargar las marcas CE: www.forim.com.
 Сведения по техническим данным маркировки CE можно найти на www.forim.com сайте

MOSAICO DI VETRO - GLASS MOSAIC TILES - MOSAÏQUE EN VERRE - GLASMOSAÏK - MOSAICO VÍTREO - СТЬКЛЯННІЯ МОЗІКІК			
CARATTERISTICHE TECNICHE - TECHNICAL CHARACTERISTICS - CARACTERISTIQUES TECHNIQUES - TECHNISCHE EIGENSCHAFTEN - CARACTERÍSTICAS TÉCNICAS - технические характеристики			
	MASSA D'ACQUA ASSORBITA IN % / % WATER ABSORPTION / MASSE D'EAU ABSORBÉE EN % / WASSERAUFNAHME IN % / MASA DE AGUA ABSORBIDA EN % / Поглощенная масса воды %	0%	ISO 10545-3
	RESISTENZA ALL'ABRASIONE / RESISTANCE TO ABRASION / RÉSISTANCE À L'ABRASION / ABRIEBHÄRTE / RESISTENCIA A LA ABRASIÓN / износоустойчивость	5*	ISO 10545-7
	DILATAZIONE TERMICA LINEARE (10 ⁻⁴ C ⁻¹) / LINEAR THERMAL EXPANSION (10 ⁻⁴ C ⁻¹) / DILATATION THERMIQUE LINEAIRE (10 ⁻⁴ C ⁻¹) / LINEARE THERMISCHE DEHNUNG (10 ⁻⁴ C ⁻¹) / DILATACION TERMICA LINEAL (10 ⁻⁴ C ⁻¹) / Коэффициент линейного теплового расширения (10 ⁻⁴ C ⁻¹)	9,1 *10 ⁻⁶ °C ⁻¹	ISO 10545-8
	RESISTENZA AL CAVILLO DI PIASTRELLE SMALTATE / GLAZE CRAZING RESISTANCE / RÉSISTANCE AU TRESSAILLAGE POUR LES CARREAUX ÉMAILLÉS / WIDERSTAND GEGEN HAARRISS VON GLASIERTEN FLIESEN - RESISTENCIA AL CUARTEADO DE LOS AZULEJOS ESMALTADOS / Стойкость глазуранной плитки к образованию кракелюра	RESISTE - RÉSISTANT RESISTE - ERFÜLLT RESISTE - Стойкая	ISO 10545-11
	RESISTENZA ALLE MACCHIE / RESISTANCE TO STAINING / RÉSISTANCE AUX TACHES / FLECKENABWEISEND / RESISTENCIA A LAS MANCHAS / нстойчивость к образованию пятен	Classe 5	ISO 10545-14
	RESISTENZA A BASSE CONCENTRAZIONI DI ACIDI E ALCALI / RESISTANCE TO LOW CONCENTRATIONS OF ACIDS AND ALKALIS. / RESISTANCE A BASSES CONCENTRATIONS D'ACIDES ET ALCALIS. / WIDERSTAND GEGEN NIEDRIGE KONZENTRATIONEN VON SÄUREN UND LAUGEN. / RESISTENCIA A BAJAS CONCENTRACIONES DE ACIDOS Y ALCALIS. / Стойкость к кислотам и щелочам с низкой концентрацией.	Classe GLA - ULA	ISO 10545-13
	RESISTENZA A ALTE CONCENTRAZIONI DI ACIDI ED ALCALI / RESISTANCE TO HIGH CONCENTRATIONS OF ACIDS AND ALKALIS / RESISTANCE À DE HAUTES CONCENTRATIONS D'ACIDES ET BASES / BESTÄNDIGKEIT GEGEN STARK KONZENTRIERTE SÄUREN UND LAUGEN. / RESISTENCIA A ALTAS CONCENTRACIONES DE ACIDOS Y ALCALIS / Стойкость к высококонцентрированным кислотам и щелочам	Classe GHA - UHA	
	RESISTENZA AI PRODOTTI CHIMICI DI USO DOMESTICO E AGLI ADDITIVI PER PISCINA / RESISTENCE TO DOMESTIC CHEMICAL PRODUCTS AND ADDITIVES FOR SWIMMING POOLS / RÉSISTANT AUX PRODUITS CHIMIQUES À USAGE DOMESTIQUE ET AUX ADDITIFS POUR PISCINE / WIDERSTAND GEGEN HAUSHALTSCHMIKALIEN UND SCHWIMMBADZUSATZSTOFFEN / RESISTENCIA A PRODUCTOS PARA LIMPIEZA DOMESTICA Y ADITIVOS PARA PISCINAS / Стойкость к бытовым химическим веществам и добавкам для бассейнов	Classe GA - UA	
	RESISTENZA DEI COLORI ALLA LUCE / COLOURS' RESISTANCE TO FADING / RÉSISTANCE DES COULEURS À LA LUMIÈRE / FARBBESTÄNDIGKEIT / RESISTENCIA DE LOS COLORES A LA LUZ / УСТОЙЧИВОСТЬ КРАСОК К СВЕТУ	RESISTE - RÉSISTANT RESISTE - ERFÜLLT RESISTE - Стойкая	DIN 51094
	COEFFICIENTE D'ATTRITO (SCIVOLosità) / FRICTION COEFFICIENT (SLIPPERINESS) / COEFFICIENT DE FRICTION (GLISSEMENT) / REIBUNGSKOEFFIZIENT (SCHLUPFRIGKEIT) - COEFICIENTE DE ANTI DESLIZAMIENTO / Коэффициент трения	A + B + C	DIN 51097

*PROVA ESEGUITA SU WHITE - TEST CARRIED OUT ON WHITE - ESSAI EXÉCUTÉ SUR WHITE - PROBEN DURCHFÜHRT WHITE - PRUEBA EJECUTADA SOBRE WHITE - ИСПЫТАНИЕ ВЫПОЛНЕНО НА WHITE



CERTIFICAZIONI

CERTIFICATIONS

CERTIFICATIONS

ZERTIFIZIERUNGEN

CERTIFICACIONES

Сертификаты



**Certificazione di sistema / System certification / Certification de système
Systemzertifizierung / Certificación de sistema / сертификация системы**

La soddisfazione del Cliente, nel rispetto dell'Ambiente e della Sicurezza dei propri collaboratori, è la condizione essenziale per il successo della nostra azienda. Di conseguenza, Florim si impegna a porre come obiettivo prioritario il costante miglioramento dei propri prodotti e servizi. Florim Ceramiche S.p.A SB è la prima azienda nel settore a ottenere la certificazione del proprio Sistema di Gestione della Qualità, dell'Ambiente e della Salute e Sicurezza dei lavoratori e dell'energia, in base alle norme **UNI EN ISO 9001, UNI EN ISO 14001, ISO 45001 e UNI EN ISO 50001**, relativamente a progettazione, produzione e vendita di piastrelle ceramiche in tutte le tipologie produttive.

Customer satisfaction, together with respect for the environment and for the safety of those who work with us are essential conditions for our company's success. As a result, Florim is committed to making the constant improvement of its products and services a priority. Florim Ceramiche S.p.A SB is the first company in the sector to obtain certification for its Quality Management System, its Environmental Management System and its Management System for the Health and Safety of workers and energy, according to **UNI EN ISO 9001, UNI EN ISO 14001, ISO 45001 and UNI EN ISO 50001** standards, relating to the design, manufacture and sales of ceramic tiles in all of its production types.

La satisfaction du client, dans le respect de l'environnement et de la sécurité de ses collaborateurs, est la condition essentielle au succès de notre entreprise. Florim s'engage donc à faire de l'amélioration constante de ses produits et services un objectif prioritaire. Florim Ceramiche S.p.A SB est la première entreprise du secteur à obtenir la certification de son système de gestion de la qualité, de l'environnement, de la santé et de la sécurité des employés et de énergie, conformément aux normes **UNI EN ISO 9001, UNI EN ISO 14001, ISO 45001 et UNI EN ISO 50001**, en matière de conception, production et vente de tous types de carreaux céramiques.

Die Zufriedenheit des Kunden unter Berücksichtigung von Umwelt und Sicherheit unserer Mitarbeiter ist die grundlegende Bedingung für den Erfolg unseres Unternehmens. Demzufolge setzt sich die Firma Florim dafür ein, die ständige Verbesserung ihrer Produkte und Dienstleistungen zum vorrangigen Ziel zu machen. Die Firma Florim Ceramiche S.p.A SB ist das erste Unternehmen in diesem Fachbereich, das die Zertifizierung seines Managementsystems der Qualität, Umwelt und Gesundheit und Sicherheit, und energie auf Grund der Bestimmungen **UNI EN ISO 9001, UNI EN ISO 14001, ISO 45001 und UNI EN ISO 50001**, in Bezug auf Entwurf, Produktion und Verkauf von Keramikfliesen in allen Herstellungsarten erhielt.

La satisfacción del Cliente, con un respeto total del ambiente y seguridad de sus colaboradores, representa la condición esencial para el éxito de nuestra empresa. Por ello, Florim se compromete a perseguir, como objetivo prioritario, una mejora constante de sus productos y servicios. Florim Ceramiche S.p.A SB es la primera empresa en el sector que ha obtenido el certificado del Sistema de Gestión de la Calidad, Ambiente, Salud y Seguridad de los trabajadores y energía en base a la normativa **UNI EN ISO 9001, UNI EN ISO 14001, BS OHSAS 18001 y UNI EN ISO 50001**, en relación al proyecto, producción y venta de baldosas de cerámica en todas las tipologías productivas.

Важнейшее условие успеха нашей компании заключается в удовлетворении потребностей наших клиентов путем соблюдения требований по охране окружающей среды, охране труда и технике безопасности. В связи с этим приоритетной задачей компании Florim является постоянное повышение качества производимой продукции и предоставляемых услуг. Florim Ceramiche S.p.A SB является первой в своей сфере компанией, получившей сертификаты соответствия системы менеджмента качества, экологии и безопасности труда и охраны здоровья в соответствии с требованиями и энергия стандартов **UNI EN ISO 9001, UNI EN ISO 14001, ISO 45001 e UNI EN ISO 50001**, применительно к проектированию, производству и продаже керамической плитки всех производимых типов.



**Certificazioni ambientali di prodotto / Product environmental certifications / Certifications environnementales des produits
Produktzertifizierungen im Zeichen des Umweltschutzes / Certificaciones ambientales de producto / экологические сертификаты продукта**



GREENGUARD

Certification is the very first voluntary North American indoor air quality product certification created specifically for commercial building products, this certification requires that products meet stringent chemical emissions requirements for over 360 VOCs, plus a limit on the total of all chemical emissions combined. Products undergo routine monitoring and annual retesting to ensure continued compliance with the **GREENGUARD** Certification standard.



GREENGUARD GOLD

Certification was developed with the specific health sensitivities of children and other vulnerable health populations in mind and based on key criteria from public health agencies, this certification sets some of the world's most stringent emission limits on over 360 chemicals, a limit on total chemical emissions, and a limit on phthalate emissions. Products undergo routine monitoring and annual retesting to ensure continued compliance with the **GREENGUARD Gold** standard.

GREENGUARD / GREENGUARD GOLD

Per ulteriori informazioni e approfondimenti / For further details and information / Pour approfondir et obtenir de plus amples informations
Für weitere Informationen / Para obtener más información / Дополнительную информацию и подробности вы найдете на сайте: www.florim.com



ECOLABEL

EcoLabel è il marchio europeo di qualità ecologica che premia i prodotti e i servizi migliori dal punto di vista ambientale (Regolamento CE n.1980/2000). Il marchio è uno strumento selettivo, basato sulla valutazione delle qualità ecologiche e prestazionali dell'intero ciclo di vita dei prodotti, ideato per premiare i prodotti e i servizi migliori dal punto di vista ambientale. In particolare, i requisiti imposti dall'Unione Europea e riconosciuti a Florim per alcune linee di prodotto tramite la concessione del marchio EcoLabel riguardano:

- Il minore consumo energetico dei processi di produzione
- Minori emissioni nell'aria e nell'acqua
- Miglioramento dell'informazione al consumatore e della gestione dei rifiuti.

EcoLabel is the European ecological quality mark which is granted to the best products and services from an environmental point of view (EC regulation no. 1980/2000). EcoLabel is a selective tool based on assessment of the ecological and performance qualities of the entire product lifecycle and is a reward for the best products and services from an environmental point of view. In particular, Florim was rewarded with the EcoLabel for some of its product lines having met the requirements imposed by the European Union:

- Reduced energy consumption in the production processes
- Reduced emissions into the air and waterways
- Enhanced information to the consumer and improved waste management.

EU Ecolabel: nr. IT/21/04

EcoLabel est le label européen de qualité écologique décerné aux meilleurs produits et aux meilleurs services au point de vue environnement (Règlement CE n°1980/2000). Ce label qui constitue un outil sélectif, basé sur l'évaluation des qualités écologiques et des performances de tout le cycle de vie des produits, a été

créé pour récompenser les produits et les services qui ont un impact réduit sur l'environnement. Le cahier des charges imposé par l'Union européenne et la marque EcoLabel décernée à Florim pour quelques lignes de produits concernent notamment :

- La réduction de la consommation d'énergie dans les processus de fabrication
- La réduction des émissions dans l'air et dans l'eau
- L'amélioration de l'information auprès des consommateurs et de la gestion des déchets.

EcoLabel ist das europäische Umweltzeichen für Öko-Qualität, das die besten umweltfreundlichen Produkte und Dienstleistungen auszeichnet (EG-Verordnung Nr. 1980/2000). Das Umweltzeichen ist ein selektives Instrument, das auf der Beurteilung der Umwelt- und Leistungsmerkmale der ganzen Lebensdauer von Produkten basiert und zur Auszeichnung der umweltfreundlichsten Produkte und Dienstleistungen eingeführt wurde. Die von der Europäischen Union auferlegten und der Firma Florim für einige Produktlinien durch die Gewährung des EcoLabel Umweltzeichens bescheinigten Voraussetzungen sind:

- Geringerer Energieverbrauch der Produktionsprozesse
- Weniger Emissionen in die Luft und das Wasser
- Verbesserte Verbraucherinformation und Abfallverwertung.

EcoLabel es la marca europea de calidad ecológica que se otorga a los mejores productos y servicios desde el punto de vista ambiental (Reglamento CE n° 1980/2000). La marca es un instrumento selectivo, basado en la valoración de las cualidades ecológicas y prestacionales del ciclo de vida de los productos, ideado para premiar aquellos productos y servicios que cumplen con estrictos criterios relativos al medio ambiente. Más concretamente, los requisitos impuestos por la Unión Europea, y respetados por Florim como así lo acredita la concesión de la marca EcoLabel para algunas líneas de producto, son los siguientes:

- Menor consumo energético de los procesos de producción
- Menores emisiones en el aire y en el agua
- Mejora de la información al consumidor y de la gestión de los residuos.

EcoLabel является европейской маркой экологического качества, которая присваивается лучшим продуктам и услугам с экологической точки зрения (Свод правил CE n.1980/2000). Эта марка является инструментом отбора, который оценивает экологические и функциональные качества продукта на протяжении его жизненного цикла, она была задумана как способ премирования продукции и услуг, наилучших с экологической точки зрения. В частности, реквизиты, установленные Евросоюзом и признанные для некоторых линий продукции Флорим путем присвоения знака EcoLabel, предусматривают:

- минимальное энергопотребление в процессе производства
- минимальные выбросы в воздух и в воду
- улучшение информированности потребителя и совершенствование способов обработки отходов.

Certificazioni ambientali di prodotto / Product environmental certifications / Certifications environnementales des produits

Produktzertifizierungen im Zeichen des Umweltschutzes / Certificaciones ambientales de producto / экологические сертификаты продукта



BUREAU VERITAS

Bureau Veritas è il marchio che certifica la natura riciclata del materiale di cui è composto un prodotto, sottoponendo a verifica l'intero ciclo produttivo.

Viene controllata e documentata la provenienza dei materiali di riciclo, il loro dosaggio, il rispetto di alcune peculiarità tecnologiche e il raggiungimento dei parametri stabiliti della norma ISO14021:2002 dell'International Organization for Standardization e del regolamento LEED 2.2 NC del U.S. Green Building Council (USGBC). Per maggiori informazioni: www.bureauveritas.com

Bureau Veritas is the mark that certifies the recycling of the material that goes into the making of a product, by running an inspection on the entire production cycle. Checks and documentation are carried out on the provenance of the recycled material, the quantities used, the observance of certain technological particulars and the achievement of the parameters established by the ISO14021:2002 regulations of the International Organization for Standardization and the LEED 2.2 NC regulation of the U.S. Green Building Council (USGBC). For more information: www.bureauveritas.com

Bureau Veritas est une marque qui certifie que le matériau dont un produit est composé a été recyclé, en soumettant l'ensemble du cycle de production à une vérification. La provenance des matériaux recyclés est contrôlée et prouvée, de même que leur dosage et le respect de certaines caractéristiques technologiques et des paramètres définis par la norme ISO14021:2002 de l'Organisation internationale de normalisation et le règlement LEED 2.2 NC de l'U.S. Green Building Council (USGBC). Pour plus d'informations : www.bureauveritas.com

Bureau Veritas ist ein Markenzeichen, das die rezyklierte Art des Materials zertifiziert, aus dem ein Produkt besteht und dazu den gesamten Produktionszyklus prüft. Kontrolliert und beurkundet wird die Herkunft der rezyklierten Materialien, deren Dosierung, die Einhaltung einiger technologischer Eigenschaften und das Erreichen der Parameter, die von den Vorschriften ISO14021:2002 der International Organization for Standardization und von den LEED-Vorschriften 2.2 NC des U.S. Green Building Council (USGBC) vorgeschrieben werden. Für weitere Infos siehe: www.bureauveritas.com

Bureau Veritas es la marca que certifica la naturaleza reciclada del material con el que está hecho un producto, sometiendo a control todo el ciclo productivo. Se controla y documenta la proveniencia de los materiales reciclados, su dosificación, que se respeten algunas peculiaridades tecnológicas y que se alcancen los parámetros establecidos por la norma ISO14021:2002 de la International Organization for Standardization y del reglamento LEED 2.2 NC del U.S. Green Building Council (USGBC). Para más información: www.bureauveritas.com

Бюро Веритас - это сертифицирующий орган, который по итогам аудита и оценки всего производственного цикла выдает сертификат, подтверждающий соответствие качества переработанного сырья, используемого в изготовлении продукции, заданным стандартам. Аудитором проводится контроль и документирование происхождения переработанного сырья, его дозирования, соблюдения определенных технологических особенностей и наличия реквизитов, установленных стандартом ISO14021:2002 Международной Организации по Стандартизации и регламентом LEED 2.2 NC Американского совета по экологическому строительству (U.S. Green Building Council). Дополнительная информация на сайте: www.bureauveritas.com

Florim e l'ambiente

Florim and the environment / Florim et l'environnement / Florim und die umwelt / Florim y el ambiente /Florim и окружающая среда



ENVIRONMENT PRIORITY ONE / Using nature's resources responsibly

Per sottolineare l'attenzione e l'impegno verso la tutela dell'ambiente, in accordo con la norma ISO 14021 (Environmental labels and declarations) Florim afferma il proprio impegno nella continua innovazione tecnologica dei processi industriali.

To underline our care for the environment and our pledge to protect it in accordance with the ISO 14021 standards (Environmental labels and declarations), Florim affirms its commitment to continual technological innovation of the industrial processes in order.

Pour prouver l'attention qu'elle consacre depuis toujours à la protection de l'environnement, en accord avec la norme ISO 14021 (Environmental labels and declarations), la société Florim déclare son engagement dans l'innovation technologique continue des processus industriels.

Die Firma Florim möchte ihre Aufmerksamkeit und ihr Engagement zum Schutz der Umwelt gemäß der ISO-Norm 14021 (Environmental labels and declarations) hervorheben und bekräftigt deshalb, dass sie ständig auf technologische Innovation der Industrieprozesse.

Para subrayar la atención y el compromiso adquirido con la tutela del medio ambiente, de acuerdo con la norma ISO 14021 (Environmental labels and declarations) Florim reafirma su dedicación por la continua innovación tecnológica de los procesos industriales.

Чтобы подчеркнуть внимание и усилия, направленные на охрану окружающей среды, в соответствии с нормативом ISO 14021 (Environmental labels and declarations) фирма Флорим подтверждает собственные обязательства в плане постоянного технологического обновления промышленных процессов, для того чтобы.



I certificati di prova sono disponibili direttamente sui siti Internet dei vari brand, nella sezione Prove Tecniche dedicata alle diverse collezioni.

Per ulteriori informazioni e approfondimenti: www.florim.com

The test certificates are available directly on the websites of the various brands, in the Technical Test section dedicated to the different collections.

For further details and information: www.florim.com

Les certificats de test de performance sont disponibles directement sur les sites Internet des différentes marques, dans la section Essais Techniques consacrée aux différentes collections. Pour approfondir et obtenir de plus amples informations: www.florim.com

Die Prüfbescheinigungen sind direkt auf den Internetseiten der entsprechenden Brands im Bereich Technische Prüfungen der verschiedenen Kollektionen verfügbar. Für weitere Informationen: www.florim.com

Los certificados de ensayo están disponibles directamente en los sitios internet de las diferentes marcas, en la sección Ensayos Técnicos dedicada a las diferentes colecciones. Para obtener más información: www.florim.com

С испытательными сертификатами на различные марки можно ознакомиться на сайтах в интернете в разделе Технические испытания, охватывающем различные коллекции. Дополнительную информацию и подробности вы найдете на сайте: www.florim.com

Marcatura CE / CE Mark / Marquage CE / CE-Kennzeichnung / Marca CE / Маркировка се



Per ulteriori informazioni, approfondimenti e download delle marcature CE: www.florim.com

For further details and information and to download the CE marks: www.florim.com

Pour obtenir de plus amples informations, approfondir et télécharger les marquages CE: www.florim.com

Für weitere Informationen und Downloads der CE-Kennzeichnungen: www.florim.com

Para obtener más información y descargar las marcas CE: www.florim.com

Получить дополнительную, более подробную информацию, а также скачать маркировку CE можно на сайте: www.florim.com

Certificazioni di prodotto nazionali / National product certifications / Certifications de produit nationaux Nationale Produktzertifizierungen Certificaciones de producto nacionales / Национальные сертификаты на продукцию



放射性水平 A 类

Certificazione obbligatoria per l'esportazione in Cina
Certification mandatory for export to China
Certification obligatoire pour l'exportation en Chine
Für den Export nach China obligatorische Zertifizierung
Certificación obligatoria para la exportación a China
Обязательная сертификация для экспорта в Китай

Per soddisfare le richieste di norme e regolamenti locali, vi sono anche diverse certificazioni di prodotto nazionali.

Per informazioni in merito contattare www.florim.com

To cater for the requirements of local norms and regulations, various national product certifications also exist. For more details contact www.florim.com

Pour satisfaire les exigences des normes et réglementations locales, il existe également différentes certifications nationales de produit.

Pour de plus amples informations à ce sujet contacter www.florim.com

Darüber hinaus sind auch verschiedene nationale Produktzertifizierungen vorhanden, um die lokalen Anforderungen bezüglich Richtlinien und Reglementen zu erfüllen. Für Informationen dazu wenden Sie sich bitte an www.florim.com

Para satisfacer los requisitos previstos por las normas y reglamentos locales, hay también varias certificaciones de producto nacionales. Para obtener más información, contacte con www.florim.com

Для внутренних норм и требований существуют также различные национальные сертификаты на продукцию. За данными сведениями обращайтесь по адресу www.florim.com



QB-UPEC

Per informazioni relative ai dati tecnici sulla classificazione UPEC vedi il sito www.florim.com

Pour toute information concernant les données techniques sur la classification UPEC, nous vous prions de bien vouloir consulter la version française du site www.florim.com

U.S. GREEN BUILDING COUNCIL



Florim ha aderito volontariamente all'U.S. Green Building Council (USGBC), la più importante associazione statunitense di industrie appartenenti al settore edilizio, unite per promuovere edifici costruiti in accordo a precise disposizioni riguardanti la sostenibilità ambientale che sono incluse all'interno della certificazione LEED (Leadership in Energy and Environmental Design), un sistema a punteggio che misura la sostenibilità di un progetto. L'utilizzo di prodotti Florim contribuisce a ottenere punti per l'acquisizione della certificazione LEED.

Florim has voluntarily become a member of the U.S. Green Building Council (USGBC), the most important American association dedicated to environmentally sustainable building design and construction according to precise directives, which must be followed in order to obtain LEED (Leadership in Energy and Environmental Design) certification, a rating system that measures the sustainability of a project. Using Florim products contributes to getting points to achieve LEED certification.

Florim a adhéré volontairement à l'U.S. Green Building Council (USGBC), la plus grande association américaine d'industries appartenant à la filière BTP, unies pour promouvoir la réalisation de constructions conformes aux dispositions précises édictées en matière de durabilité environnementale, incluses dans la certification LEED (Leadership in Energy and Environmental Design), un système d'attribution de notes mesurant la durabilité d'un projet. L'utilisation des produits Florim contribue à l'obtention de points en vue de la certification LEED.

Florim ist freiwillig dem U.S. Green Building Council (USGBC) beigetreten, dem bedeutendsten Verband der Bauindustrien in den Vereinigten Staaten, die sich zur Förderung von Gebäuden vereinigt haben, die gewissen Nachhaltigkeitsvorschriften entsprechend gebaut werden. Diese Bestimmungen sind in der LEED-Zertifizierung (Leadership in Energy and Environmental Design), einem Punktesystem zur Bewertung der Nachhaltigkeit eines Projekts, enthalten. Der Gebrauch von Florim Produkten trägt zur Erlangung von Punkten der LEED-Zertifizierung bei.

Florim ha adherido voluntariamente al U.S. Green Building Council (USGBC), la más importante asociación estadounidense de industrias pertenecientes al sector de la construcción, unidas para promover la construcción de edificios de acuerdo con precisas disposiciones relativas a la sostenibilidad ambiental, que están incluidas en la certificación LEED (Leadership in Energy and Environmental Design), un sistema por puntos que mide la sostenibilidad de un proyecto. El uso de productos Florim contribuye a obtener puntos para adquirir la certificación LEED.

Фирма Флорим добровольно вступила в организацию U.S. Green Building Council (USGBC), самая влиятельная североамериканская ассоциация, объединяющая предприятия, занятые в строительной отрасли, для продвижения строительства зданий, отвечающих четким природоохранным требованиям, которые включены в сертификацию LEED (Leadership in Energy and Environmental Design), систему подсчета баллов, измеряющую природосберегающий аспект проекта. Использование продукции Флорим способствует получению баллов для присвоения сертификата LEED.

La certificazione LEED è una certificazione di edificio non di prodotto. Pertanto i criteri LEED fanno sempre riferimento al sistema edificio e non ai singoli materiali utilizzati nel progetto. La soglia indicata nei crediti si riferisce quindi al parametro cui l'edificio dovrà conformarsi per l'attribuzione del relativo punteggio. Sul sito Florim.com, All'interno delle certificazioni di ogni singola collezione, è disponibile la Certification Letters for LEED® Projects.

LEED certification is a building certification and not for a product. Therefore, the LEED criteria always refer to the building system and not to the individual building materials used in the project. The threshold indicated in the credits, therefore refers to the parameter to which the building must comply with for the allocation of the corresponding point score. Certification Letters for LEED® Projects are available on the Florim.com website, in the certifications for each single collection.

La certification LEED (« Leadership in Energy and Environmental Design ») est une certification qui concerne les bâtiments et non pas les produits. Ainsi, les critères LEED font toujours référence au système bâtiment et non pas aux matériaux utilisés dans le projet. Le seuil indiqué dans les crédits se réfère donc au paramètre auquel le bâtiment devra se conformer pour l'attribution des points correspondants. Sur le site Florim.com, parmi les certifications de chaque collection, la Certification Letters for LEED® Projects est disponible.

Bei der LEED-Zertifizierung handelt es sich nicht um ein Produkt- sondern ein Gebäudezertifizierungssystem. Daher beziehen sich die LEED-Kriterien immer auf das Gebäude im Ganzen, nicht auf die einzelnen für das Projekt verwendeten Materialien. Der für die Punkte angegebene Grenzwert bezieht sich daher auf den Wert, den das Gebäude einhalten muss, um die entsprechenden Punkte zu erhalten. Auf der Website Florim.com finden sich in den Zertifizierungen der einzelnen Kollektionen die Certification Letters for LEED® Projects.

La certificación LEED es una certificación para el edificio y no para el producto. Por lo tanto los criterios LEED siempre se refieren al sistema edificio y no a cada uno de los materiales utilizados en el proyecto. El umbral indicado en los créditos se refiere por lo tanto al parámetro al cual el edificio se deberá ajustar para que le sea atribuida la correspondiente puntuación. En el sitio web Florim.com, en la sección de las certificaciones de cada colección, están disponibles las Certification Letters for LEED® Projects.

Сертификация LEED – это сертификация зданий, а не продукта. Таким образом, критерии LEED распространяются на систему здания в целом, а не на отдельные строительные материалы, используемые в реализации проекта. Следовательно, указанное в системе оценки пороговое значение относится к параметру, которому должно соответствовать здание для получения определенного количества баллов. На сайте Florim.com, среди сертификатов, выданных для каждой отдельной коллекции, можно найти сертификационные письма на проекты LEED®.



ENVIRONMENTAL PRODUCT DECLARATION

L'EPD è una Dichiarazione Ambientale di Prodotto certificata e verificata in modo indipendente, che esprime in modo trasparente e oggettivo le prestazioni ambientali di un prodotto lungo il suo ciclo di vita, in accordo con lo Standard internazionale ISO14025. L'EPD è basata su specifiche regole che ne definiscono le metodologie di calcolo: le Product Category Rules (PCR), e non prevede soglie prestazioni.

The EPD is a certified and independently verified Environmental Product Declaration that expresses in a transparent and objective manner the environmental performance of a product throughout its life cycle, in accordance with the International Standard ISO14025. The EPD is based on specific rules that define the calculation methodologies: the Product Category Rules (PCR), and does not provide for performance thresholds.

La DEP est une Déclaration Environnementale de Produit certifiée et vérifiée de façon indépendante, décrivant de manière transparente et objective les performances environnementales d'un produit tout au long de son cycle de vie, conformément à la norme internationale ISO 14025. La DEP s'appuie sur des règles spécifiques qui définissent ses méthodes de calcul : les Product Category Rules (PCR), et ne prévoit pas de seuils de performance.

EPD ist eine zertifizierte und unabhängig kontrollierte Produkt-Umwelterklärung, die, übereinstimmend mit der internationalen Norm ISO14025, auf transparente und objektive Weise die Umweltleistungen eines Produkts während seines Lebenszyklus bekundet. EPD basiert auf spezifischen Regeln, die die Berechnungsmethode festlegen: die Product Category Rules (PCR), die keine Leistungsschwellen vorsehen.

La DAP es una declaración ambiental de producto, certificada y verificada de manera independiente, que informa acerca del desempeño ambiental de un producto a lo largo de su ciclo de vida de forma transparente y objetiva, de conformidad con la norma internacional ISO 14025. La DAP se basa en reglas específicas que definen sus métodos de cálculo, denominadas Reglas de categoría de producto (RCP), y no prevé umbrales de desempeño.

EPD - это экологическая декларация продукции, сертифицированная и проверенная независимой организацией, которая понятно и объективно документирует воздействие продукции на окружающую среду в течение ее жизненного цикла, в соответствии с международным стандартом ISO 14025. Декларация EPD не предусматривает предельные характеристики и основана на специальных правилах, определяющих методы расчета, которые известны под названием правила по категориям продукции (Product Category Rules, PCR).

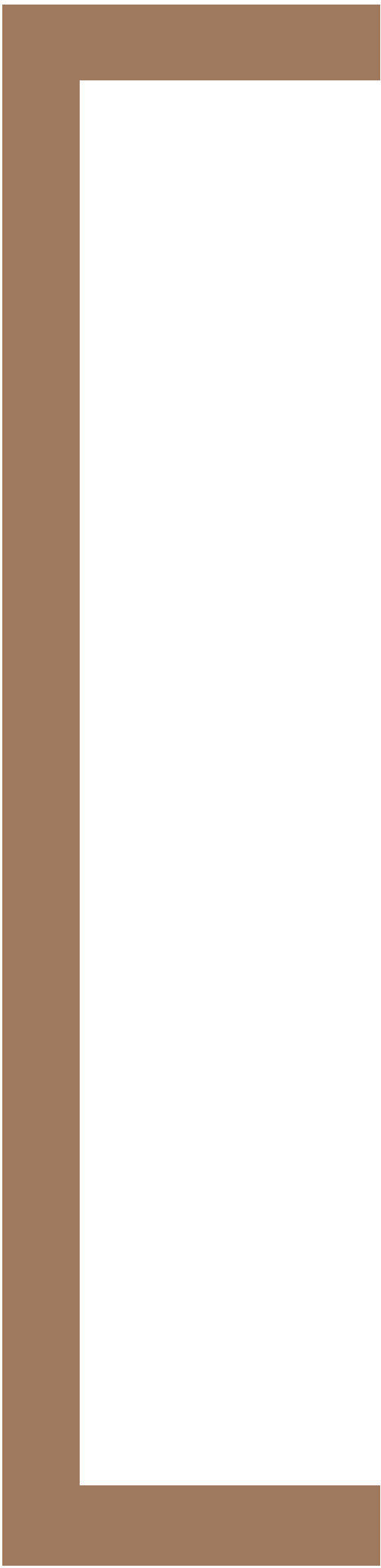

CONDIZIONI GENERALI DI VENDITA

GENERAL CONDITIONS OF SALE
CONDITIONS GÉNÉRALES DE VENTE
ALLGEMEINE GESCHÄFTSBEDINGUNGEN
CONDICIONES GENERALES DE VENTA
ОБЩИЕ УСЛОВИЯ ПРОДАЖИ

Quanto contenuto nel catalogo è indicativo e non esaustivo riguardo alle grafiche, decori e ai colori riportati.

Contents of this catalog is indicative and not exhaustive with regard to graphics, decors and colors shown.

Le contenu du catalogue est indicatif et non exhaustive en ce qui concerne graphiques, décors et couleurs indiquées.

Die Beschreibungen im Katalog sind indikativ und nicht allumfassend in Bezug auf Grafiken, Dekore und Farben.

El contenido de este catálogo es indicativo y no exhaustivo con respecto a gráficas, decoros y colores ilustrados.

Информация, содержащаяся в каталоге - ориентировочна а не исчерпывающая по поводу процитированных график, декоративных элементов и цветов.



Florim Ceramiche S.p.A. SB

Via Canaletto, 24 /41042 Fiorano Modenese (MO) / T. +39 0536 840111 / F. +39 0536 844750 / florim.com