

the 29th edition

INTERNATIONAL EXHIBITION MUESTRA INTERNACIONAL



noken

El
séptimo
cielo

On the occasion of the 29th Porcelanosa International Exhibition, we've given our Noken showroom a whole new look, based on the 'Seventh Heaven' theme.

Seventh heaven, a state of wellbeing reached through the benefits of water and the power of the wellness.

Join us in the journey through the three states of water to this state of total ecstasy.

Con motivo de la XXIX Mostra Internacional Porcelanosa, el showroom de Noken se renueva por completo en base al leitmotiv "Séptimo Cielo".

Llegar al séptimo cielo, un estado de bienestar, a través de los beneficios del agua y el poder del Wellness.

Acompáñanos a través de los tres estados del agua a este estado de éxtasis total.



Liquid Líquido



Steam Vapor



Solid Sólido

Index

Brassware / Grifería

Swan _____	2
Lignage _____	8
Round _____	12
Round/Square _____	16

Wellness / Wellness

NK Energy _____	20
Seasons _____	26
Lounge _____	32
Touch&Feel _____	38

Basins / Lavabos

Slender _____	42
----------------------	-----------

Installation systems / Sistemas de instalación

Contracts Line _____	46
-----------------------------	-----------

Towel warmers / Secatoallas

Terra _____	50
--------------------	-----------

Bathroom furniture / Muebles de baño

Oxo _____	54
Forma _____	62
Lounge _____	70
Architect _____	78
NK Concept _____	84

Swan

Brassware / Grifería



Timeless beauty

SWAN

ERRE

SWAN

Is an animal associated with elegance and beauty.

Some mythologies claim that it is a divine animal because its soul never dies. It is a "timeless" animal.

Its appearance and feathers are pure lightness.

SWAN

El cisne es un animal asociado a la elegancia y la belleza.

Hay mitologías que afirman que es un animal divino porque su alma jamás muere. Es un animal "atemporal".

Su aspecto y plumaje es pura ligereza.

Its simple **geometric shapes** pursue a long-lasting design.

Sus **formas geométricas** simples buscan un diseño que perdure en el tiempo.

Its studied **ergonomics** seek functionality in use.

Its **ecological nature** has been conceived from the design phase to obtain environmentally friendly taps, and with that in mind, we work with technologies that allow us to combine design and ecology, achieving a unique product.

Su estudiada **ergonomía** busca la funcionalidad en el uso.



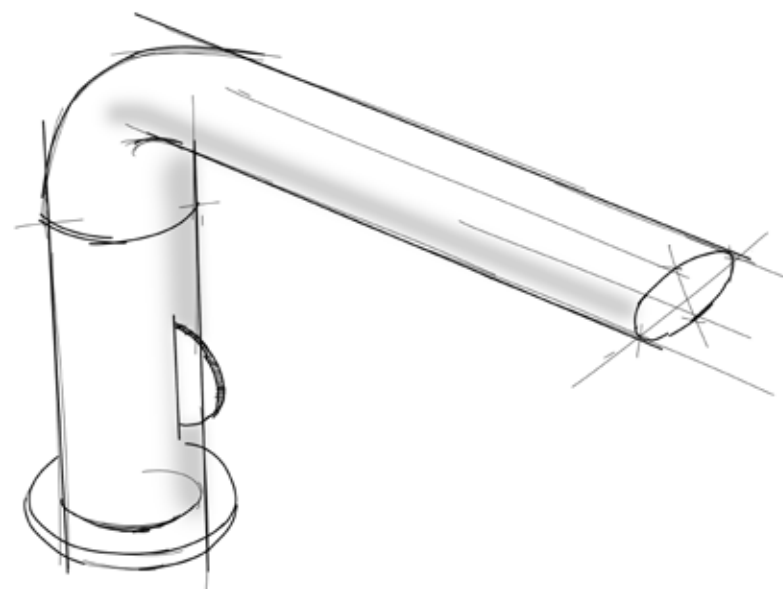

Su **carácter ecológico** nace desde la fase de diseño con el objetivo de ser una grifería respetuosa con el medio ambiente, y para ello trabajamos con tecnologías que nos permitan combinar diseño y ecología, para conseguir un producto único.

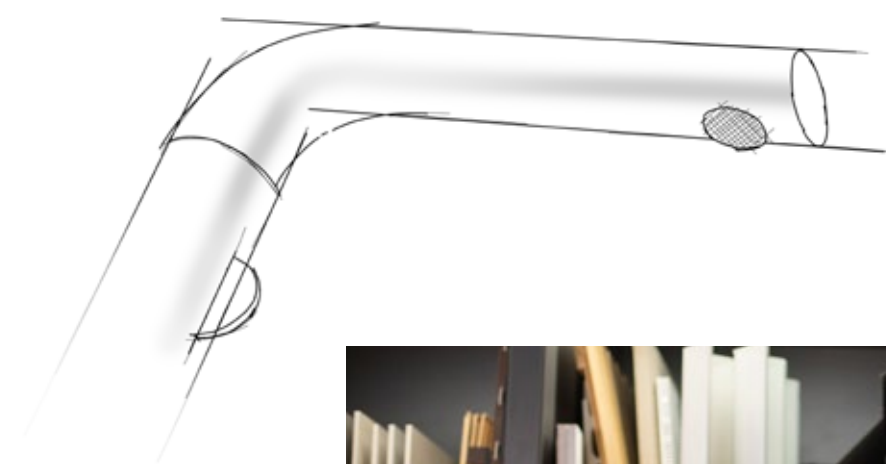
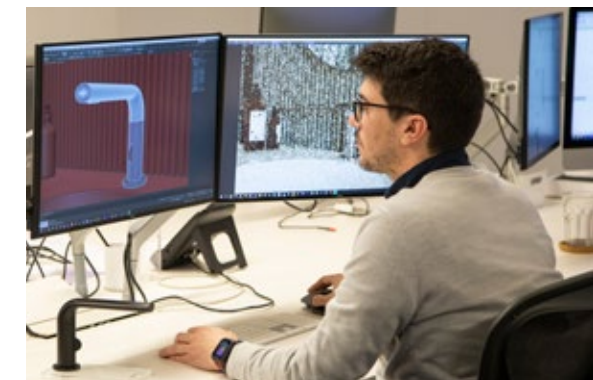

United by their values, essence and common goals, Noken Porcelanosa Bathrooms and the architectural firm ERRE are collaborating to create taps much needed in our bathrooms.

Unidos por sus valores, esencia y objetivos comunes, Noken Porcelanosa Bathrooms y ERRE arquitectura colaboran para crear una grifería necesaria en nuestros baños.



-  Chrome
-  Cromo
-  Matt black
-  Negro mate



M. Ángeles Ros (Partner Architect) and Javier Estevan (Project Director for Residential and Singular Projects)
M. Ángeles Ros (Socio Arquitecto) y Javier Estevan (Director de equipo proyectos residenciales y singulares)



ERRE design team.
Equipo de diseño ERRE arquitectura.



M. Angeles Ros (Partner Architect), Jose Martí (Partner Architect) and Amparo Roig (Partner Architect).
 M.Ángeles Ros (Socio Arquitecto), Jose Martí (Socio Arquitecto) y Amparo Roig (Socio Arquitecto).



Roig Arena (Valencia)

ERRE is an architectural firm based in Valencia, Spain. It is made up by a great team of professionals specialising in residential, educational, sports and office projects for more than 20 years.

ERRE is committed to an architecture based on knowledge, innovation and sustainability. Each project represents a new challenge in understanding and meeting the needs of its clients by providing functional solutions to enhance the life of the user enjoying it.

They integrate technology, industrialisation and creativity to achieve projects that go beyond the assignment, contributing to cities and healthy environments designed for people.

ERRE es un estudio de arquitectura con sede en Valencia, España. Formado por un gran equipo de profesionales especializado en proyectos residenciales, educativos, deportivos y oficinas desde hace más de 20 años.

En ERRE apuestan por una arquitectura basada en el conocimiento, la innovación y la sostenibilidad. Cada proyecto supone un nuevo reto con el que entender y satisfacer las necesidades de sus clientes aportando soluciones funcionales con las que conseguir mejorar la vida del usuario que lo disfruta.

Integran tecnología, industrialización y creatividad para alcanzar proyectos que van más allá del propio encargo, generando ciudad y entornos saludables pensados para las personas.



Clínica Alejandría (Valencia) - David Zarzoso

Lignage

Brassware / Grifería



CARRARA



Natural marble
Mármol natural

LIGNAGE

DESIGNED BY *Xavier Esteve*



NEW FINISH, NEW STYLES:
SIMPLE GOLD

NUEVO ACABADO,
NUEVOS ESTILOS:
EL DORADO SENCILLO



The marble handle takes us back to the twenties, contrasting the luxuriousness of marble with the simplicity of the tap's form. An art deco jewel.



La maneta de mármol nos transporta a los años veinte donde el lujo del mármol se contrasta con la simplicidad de las formas de la grifería. Una joya art déco.



Brushed gold will elevate an industrial style subtly, and elegantly. This is why we have incorporated this new finish into our Lignage taps, signature pieces designed by Ramón Esteve.

El oro cepillado eleva el estilo industrial en sutileza y elegancia, y por ello incorporamos este nuevo acabado en la grifería Lignage, una pieza de autor diseñada por Ramón Esteve.

Finish Studio

-  Chrome
Cromo
-  Gold
Oro
-  Brushed copper
Cobre cepillado
-  Brushed gold
Oro cepillado



Round

Brassware / Grifería





The Round collection, designed with a subtle and delicate aesthetic, is product of the highest quality and latest market trends. All of this in addition to the **ECO** awareness fervently supported by Noken Porcelanosa Bathrooms, creating pieces that focus on comfort as well as on efficiency and water saving.

La colección Round diseñada con una estética sutil y delicada, bebe de la máxima calidad y las últimas tendencias del mercado. Todo ello unido a la conciencia **ECO** que tanto defiende Noken Porcelanosa Bathrooms, concibiendo piezas que incentivan el confort pero pensando al mismo tiempo en la eficiencia y el ahorro de agua.

Care in the design of shapes and details.

Cuidado en el diseño de las formas y detalles.

Finish Studio

A new component joins these taps to further enhance its refined and practical design. Handles in stone finishes add a touch to our warm and perfect bathroom. Metallic finishes in gold and copper have also been designed for the more distinguished and elegant bathrooms. They are also the perfect combination with the Slender Finish Studio handcrafted washbasins.

Un nuevo componente se suma a esta grifería para realzar, más aún, su diseño refinado y práctico. Manetas en acabados piedra, dan un toque a nuestro baño cálido y perfecto. Unidos a estas, se suman los acabados metalizados en oro y cobre, para los baños más distinguidos y elegantes. Son además la combinación perfecta con los lavabos artesanales Slender Finish Studio.

-  Carrara marble
Carrara marble
-  Marfil stone
Marfil stone
-  Caliza concrete
Caliza concrete
-  Marquina stone
Marquina stone
-  Dark concrete
Dark concrete
-  Copper
Cobre
-  Gold
Oro



Round & Square

Brassware / Grifería



Finish Studio

The Round and Square series: geometric forms and timeless finishes. The new taps enshrine the 'less is more' philosophy, keeping only the essential components on show, without losing their sustainable ethos.

Formas geométricas y acabados atemporales para las series Round y Square. Las nuevas griferías persiguen la filosofía de 'menos es más' para mostrar solo lo esencial sin perder su alma sostenible.

Chrome
Cromo



Matt black
Negro mate



Titanium
Titanio



Brushed titanium
Titanio cepillado



Copper
Cobre



Brushed copper
Cobre cepillado



Gold
Oro



Brushed gold
Oro cepillado



Thanks to their finishes and materials, these two pieces share uniqueness and elegance.

Unidas por sus acabados y materiales, estas dos piezas comparten personalidad y elegancia.

The various finishes make them perfectly suited to all spaces, giving these a distinctive touch with colour. Part of the WaterForest range with ECO technology, they boast a water consumption limit of up to 5 litres/minute.

Sus diferentes acabados les permiten encajar a la perfección en todos los espacios, dando toques distinguidos y de color. Englobados dentro de la gama WaterForest con tecnología ECO respetuosa con el medio ambiente que limita el consumo de agua hasta 5 litros/minuto.



Noken Energy

Wellness / Wellness



Get an appointment with yourself to enjoy
a hydrotherapy treatment with the new Noken Energy sprays.

Pide cita contigo mismo para disfrutar de un tratamiento de
hidroterapia con los nuevos rociadores Noken Energy.



Noken Energy is a new type of jet that surrounds you in a soft and pleasant rain that refreshes and revitalises. Each nozzle has five micro- holes (instead of one) that divide the stream into micro droplets. This creates a new shower sensation that is much more relaxing and silent.

Noken Energy es un nuevo tipo de chorro que te envuelve en una suave y agradable lluvia que refresca y revitaliza. Cada tetina tiene cinco finos orificios (en vez de uno) que dividen el chorro en micro gotas. Esto crea una nueva sensación de ducha mucho más relajante y silenciosa.



NOKEN ENERGY



Relaxing. Many more micro-drop jets that make the water fall as small and light drops, achieving a much more relaxing and pleasant shower.

Relajante. Muchos más chorros de microgotas que hacen que el agua caiga como pequeñas y ligeras gotas consiguiendo una ducha mucho más relajante y placentera.



More silent. water flows quietly from the nozzles and falls gently on you, producing less noise than a standard shower.

Más silencioso. El agua sale silenciosa de las tetinas y cae suavemente sobre ti produciendo menos sonido que una ducha estándar.



Less splashing. water falls so lightly on your skin that it reduces splashing. This helps you keep the bathroom clean.

Menos salpicaduras. El agua cae tan ligeramente sobre tu piel que disminuye la cantidad de salpicaduras. Esto te ayuda a mantener limpio el baño.



Easy to clean. Silicone nozzles can be easily cleaned and removing any limescale that may accumulate on them is easy.

Fácil de limpiar. Las tetinas de silicona se pueden limpiar fácilmente eliminando la posible cal que se acumule en ellas.

ROUND / SQUARE



Safety valve. The integrated valve incorporated in the ball joint prevents any damage resulting from high pressure peaks.

Válvula de seguridad. Gracias a la válvula incorporada en la rótula evitamos posible roturas por picos altos de presión.



AISI 304. The stainless steel construction improves corrosion resistance and durability.

AISI 304. Fabricados en acero inoxidable conseguimos una mayor resistencia a la corrosión y durabilidad.



ECO-FLOW. The flow limiter saves water.

ECO-FLOW. Gracias al limitador de caudal conseguimos ahorro de agua.

In any form, these sprays will create an atmosphere of relaxation with their droplet treatment. A silent, relaxing rainfall shower that will caress every part of your body so you can enjoy a spa experience at home.

En cualquiera de sus formas, los rociadores Round y Square con el sistema Noken Energy crearán una atmósfera de relajación con su tratamiento de microgotas. Una lluvia relajante y silenciosa que acariciará cada parte de tu cuerpo para que disfrutes de una experiencia spa en casa.

SQUARE / ROUND

20

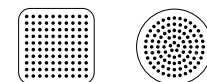

30

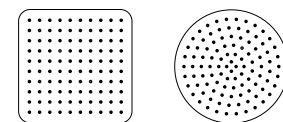

40

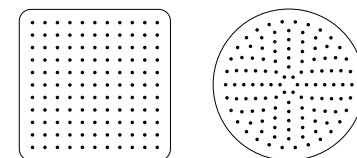

- 1 Rain / Lluvia
- 2 Massage / Masaje
- 3 Laminar spray / Chorro central

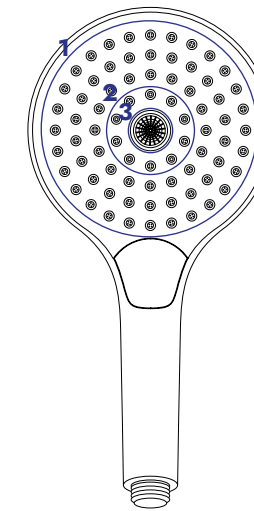

The new handle features all the benefits of the Noken Energy system in its rain function; that is, in addition to the massage and jet functions that complete the shower experience. The handle also includes a nozzle cleaning system.

La nueva maneta nos ofrece todas las ventajas del sistema Noken Energy en su función lluvia. Además de las funciones de masaje y chorro para completar nuestra experiencia en la ducha. La maneta incluye también un sistema de limpieza de tetinas.



Button for cleaning lime in the nozzles.
Botón para la limpieza de la cal en las tetinas.

Seasons

Wellness / Wellness



WELLNESS NOKEN

CHROMO
THERAPY

HYDRO
THERAPY

AROMA
THERAPY

Finish Studio

And if we add the vitality that the special finishes contribute to the shower-spa? The Seasons showerheads are now included with **Finish Studio** in the new finishes and formats. We have added to the collection round formats with diameters of 35 and 65 centimetres.

¿Y si añadimos la vitalidad que nos aportan los acabados especiales a la ducha-spa? Los rociadores Seasons se unen a **Finish Studio** con sus nuevos acabados y nuevos formatos. Añadimos a la colección los formatos redondos de diámetro 35 y 65 centímetros.

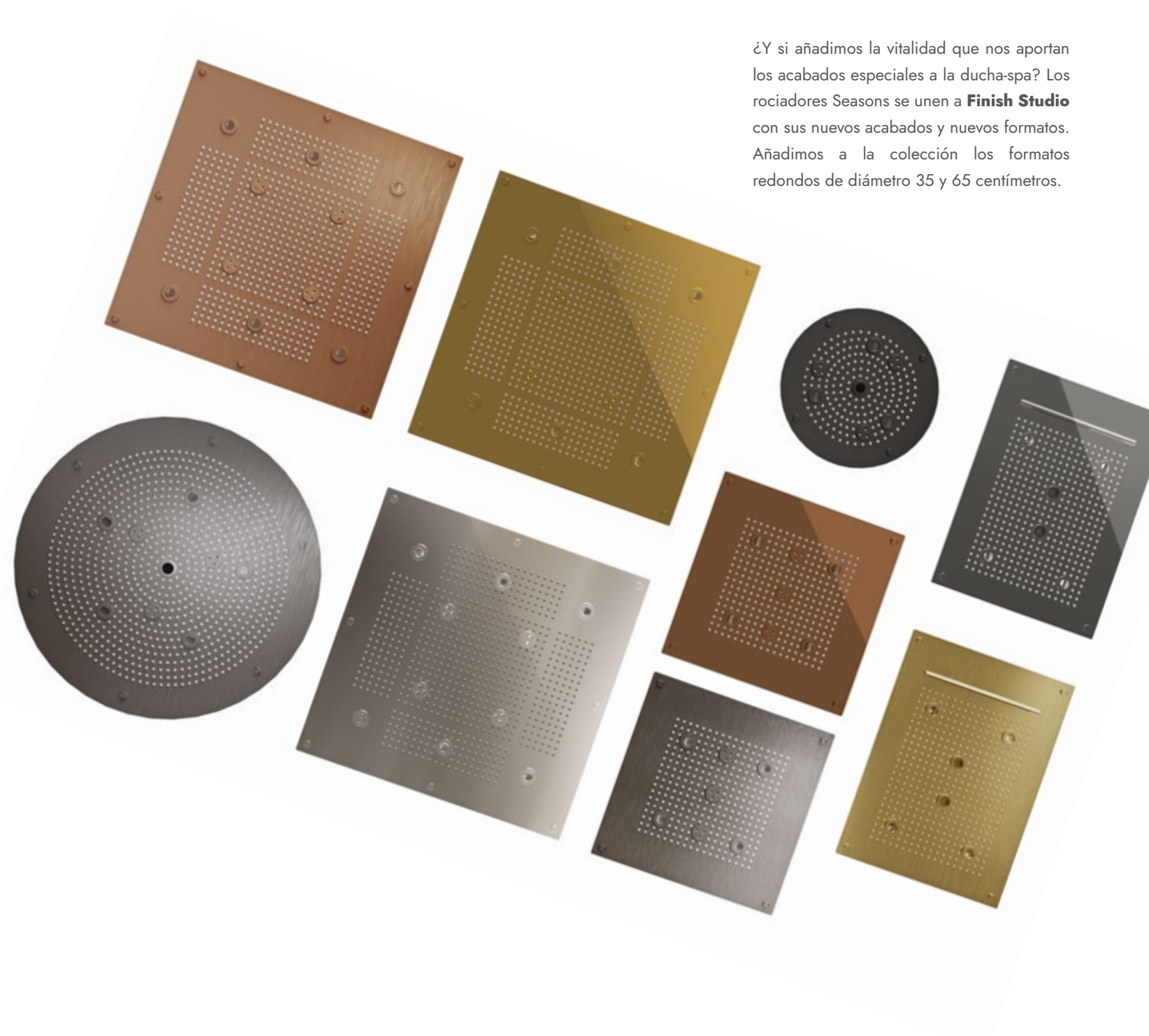



 Inox mirror
Inox espejo

 Inox mirror
Inox espejo

 Black
Negro

 Gold
Oro

 Copper
Cobre

 Titanium
Titanio

 Brushed gold
Oro cepillado

 Brushed copper
Cobre cepillado

 Brushed titanium
Titanio cepillado

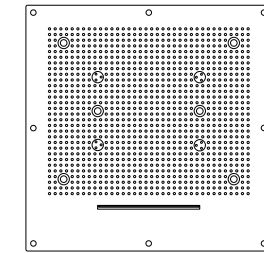

65x65

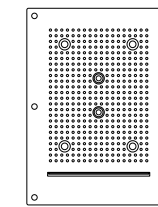

52x38

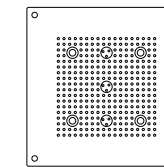

42x42

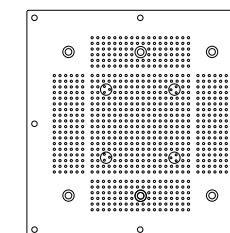

60x60

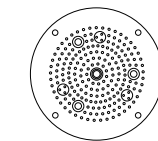

NEW

35ø

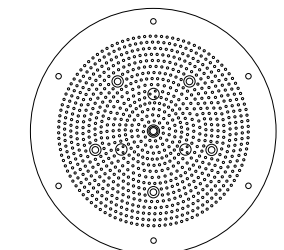

NEW

65ø





Chromotherapy is not only a beautiful play of light and colours. There are several studies certifying the full functionality of this practice, and helps establishing emotional balance for dealing with everyday problems. From a range of cold colours, so related to relaxation and tranquility, to the vital energy given by warm colours, chromotherapy, together with the effect of the different outlets, can lead to highly significant benefits for body and mind.

La cromoterapia no es sólo un bonito juego de luces y colores. Existen diversos estudios que certifican esta práctica como totalmente funcional, y que puede ayudar a establecer un equilibrio emocional que ayude a lidiar con los problemas del día a día. Desde una gama de colores fríos que tan asociados son al relax y a la tranquilidad hasta los colores cálidos que tanta energía vital otorgan, esta práctica, junto con el efecto de los diferentes tipos de salida de agua, puede desembocar en unos beneficios extremadamente significativos para el cuerpo y la mente.



With aromatherapy, a variety of perfumes and aromas evoke scenarios and ambient settings which bring equilibrium to our mental, physical and energy centres, resulting in a sense of serenity.

Con la aromaterapia, una variedad de perfumes y aromas evocan escenarios y ambientes que traen equilibrio a nuestros centros mentales, físicos y energéticos, resultando en una sensación de serenidad.

Inspired by the different natural phenomena, Seasons sprays take us on a journey with their multiple benefits: rainfall, waterfall, jets and mister.

Inspirados en cada uno de los fenómenos de la naturaleza, los rociadores Seasons nos hacen viajar con sus múltiples beneficios: lluvia, cascada, chorros y nebulizador.



Lounge

Wellness / Wellness

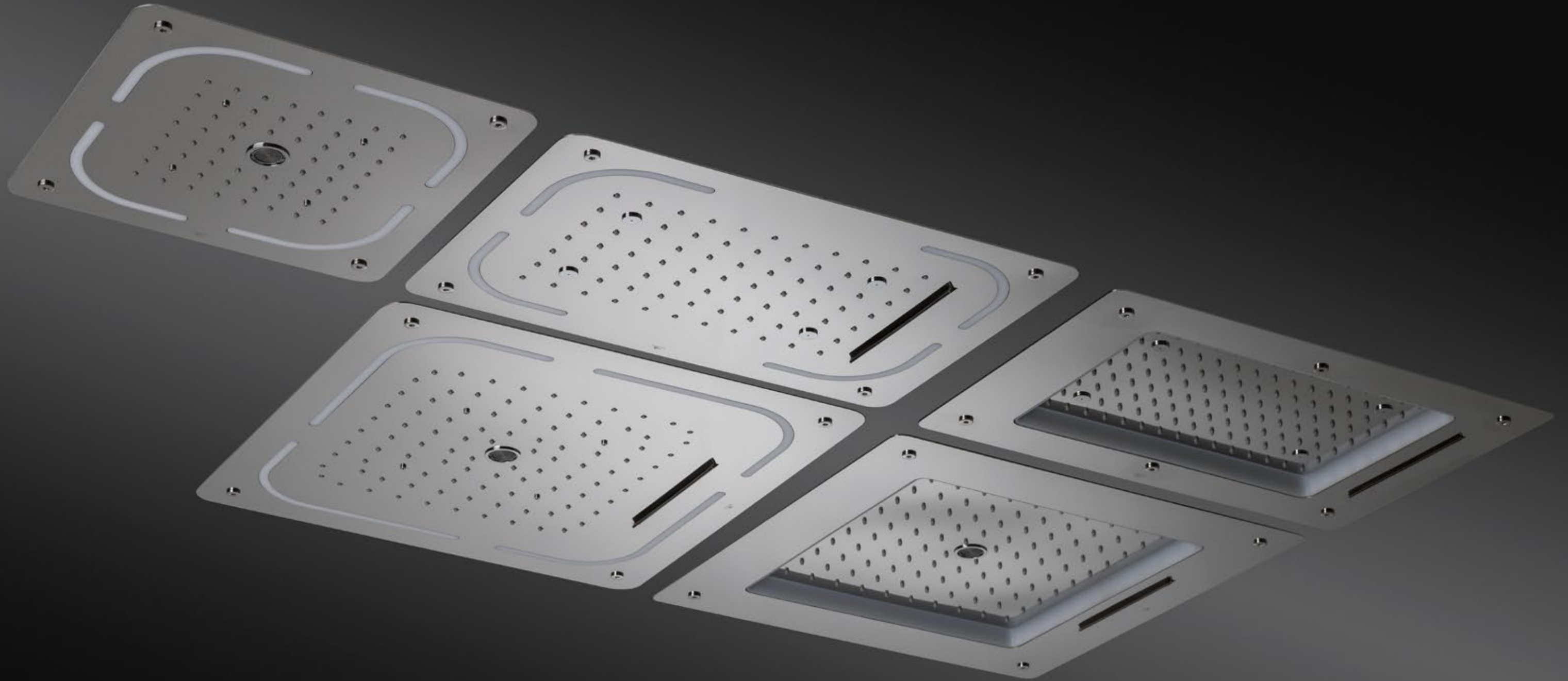

WELLNESS NOKEN

CHROMO
THERAPY

HYDRO
THERAPY

AROMA
THERAPY

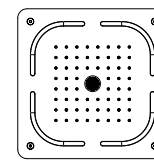
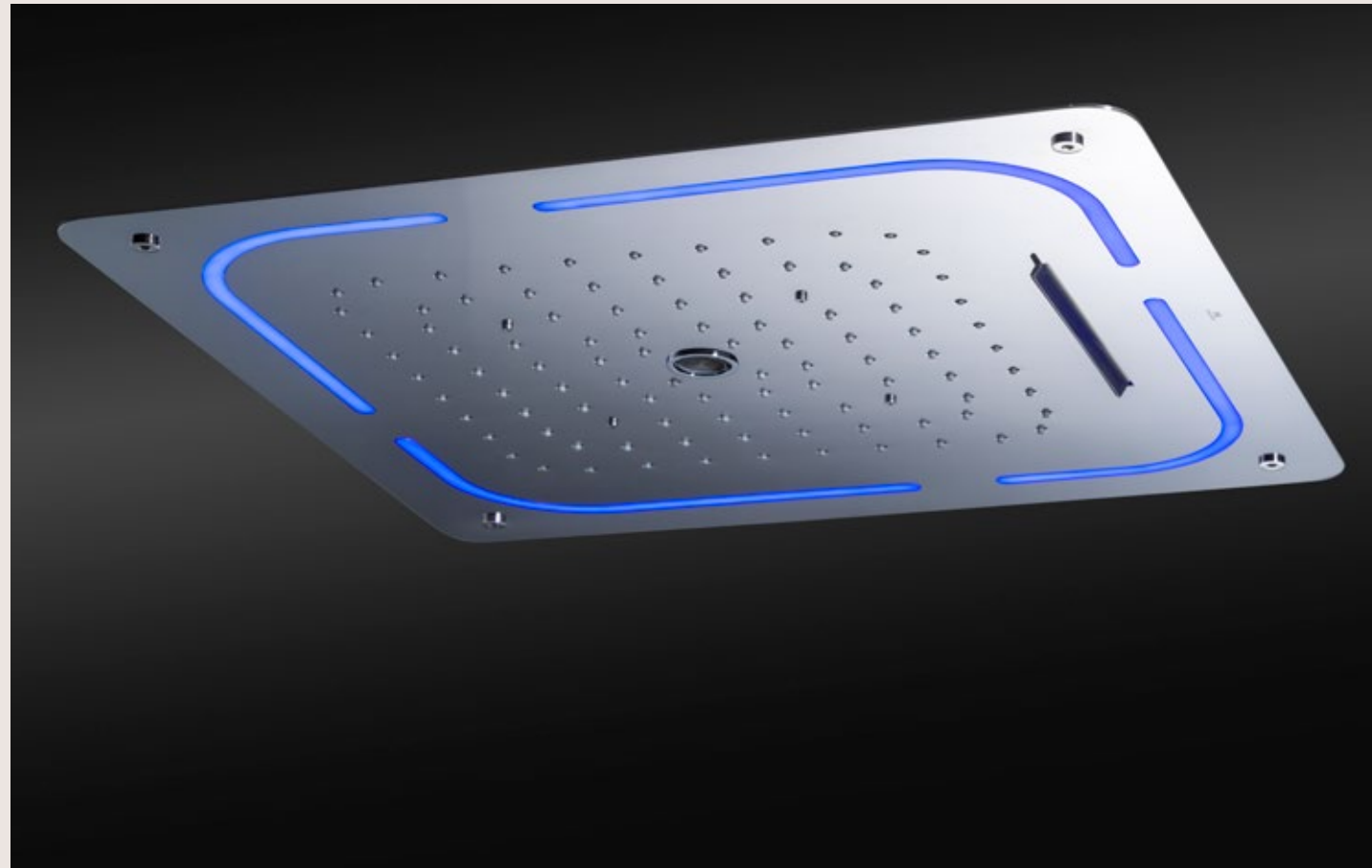

40x40

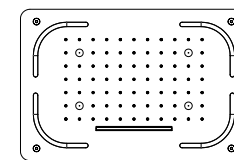

40x60

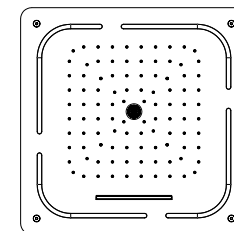

60x60

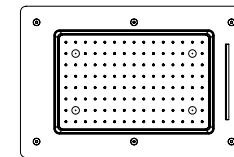

40x60

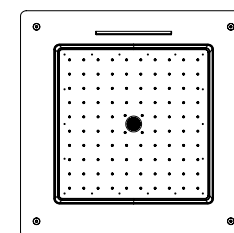

60x60



The Lounge series has been updated with a new range of showerheads.

La serie Lounge se actualiza con una nueva gama de rociadores.

Two new designs with different functions and sizes to meet the **Wellness** needs of our home. These showerheads provide a personalised shower experience, with their different flow functions, such as rain, waterfall and jet; and chromotherapy and aromatherapy programmes.

Dos novedosos diseños con distintas funciones y tamaños para satisfacer las necesidades **Wellness** en nuestro hogar. Estos rociadores permiten una experiencia de ducha a medida, a través de diferentes funciones de agua como lluvia, cascada y chorro; además de la cromoterapia y aromaterapia.

The aromatherapy kit is still offered in the three fragrances featured by the collection: Energy, Relax and Floreale.



El kit de aromaterapia continúa con las tres fragancias propias de la colección: Energizante (Energy), relajante (Relax) y floral (Floreale).

The rain function has been added to the **Noken Energy** system, achieving a much more relaxing shower.

La función lluvia añade el sistema **Noken Energy** consiguiendo una ducha mucho más relajante.



NOKEN ENERGY



Relaxing. Many more micro-drop jets that make the water fall as small and light drops, achieving a much more relaxing and pleasant shower.

Relajante. Muchos más chorros de microgotas que hacen que el agua caiga como pequeñas y ligeras gotas consiguiendo una ducha mucho más relajante y placentera.



More silent. water flows quietly from the nozzles and falls gently on you, producing less noise than a standard shower.

Más silencioso. El agua sale silenciosa de las tetinas y cae suavemente sobre ti produciendo menos sonido que una ducha estándar.



Less splashing. water falls so lightly on your skin that it reduces splashing. This helps you keep the bathroom clean.

Menos salpicaduras. El agua cae tan ligeramente sobre tu piel que disminuye la cantidad de salpicaduras. Esto te ayuda a mantener limpio el baño.



Easy to clean. Silicone nozzles can be easily cleaned and removing any limescale that may accumulate on them is easy.

Fácil de limpiar. Las tetinas de silicona se pueden limpiar fácilmente eliminando la posible cal que se acumule en ellas.

SHOWER HEAD



AISI 304. The stainless steel construction improves corrosion resistance and durability.

AISI 304. Fabricados en acero inoxidable conseguimos una mayor resistencia a la corrosión y durabilidad.



ECO-FLOW. The flow limiter saves water.

ECO-FLOW. Gracias al limitador de caudal conseguimos ahorro de agua.



Touch & Feel

Wellness / Wellness



Touch&Feel brings you a unique showering experience with various sensations: massage effect, rainfall, and an additional waterfall setting on new columns in chrome and matt black.

Touch&Feel nos invita a experimentar sensaciones únicas en la ducha: efecto masaje, lluvia y ahora también cascada con las nuevas columnas en cromo y negro mate. Además con la posibilidad de accionar lluvia y cascada al mismo tiempo.



Chrome
Cromo



Black
Negro





-  Cascade
Cascada
-  Rain
Lluvia
-  Rain + cascade
Lluvia + cascada
-  Handshower
Teleducha



The touch & feel shower hose has been designed for maximum comfort and functionality and offers 3 relaxing functions.

La teleducha touch & feel diseñada para un máximo confort y funcionalidad nos ofrece 3 relajantes funciones.



One of the advantages of these columns is Noken Safe Stop, which stops the water temperature from exceeding 38°C, protecting the user from accidental burns, especially for children and the elderly. This technology will also cut off the hot water supply if the cold water flow is interrupted, avoiding the risk of burns.

Plus, these models also come with Noken Thermostrust. This technology ensures the thermostatic component stays cold, avoiding potential burns. It means you can enjoy your everyday snippets of wellness and relaxation with absolute peace of mind.

Una de las ventajas de estas columnas es el sistema Noken Safe Stop, que con su bloqueo de agua a 38°C, protege al usuario evitando quemaduras accidentales, especialmente para niños y personas mayores. Adicionalmente en caso de interrupción de suministro de agua fría la columna corta el agua caliente para evitar el escaldamiento.

Por otro lado, estos modelos incluyen Noken Thermostrust. Esta tecnología garantiza que la temperatura del cuerpo termostático se mantendrá fría evitando así posibles quemazones. De ese modo se puede disfrutar al cien por cien cada día de pequeños momentos de bienestar y tranquilidad.

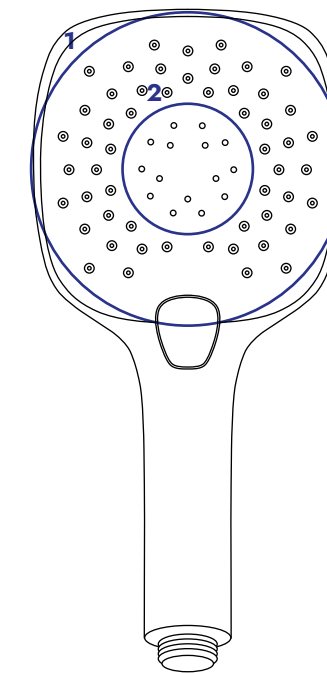

- 1**  Rain
Lluvia
- 2**  Massage
Masaje
- 1+2**  Rain + massage
Lluvia + masaje

Slender

Basins / Lavabos

Finish Studio

Using an artisanal process where the sensory experience is essential, the Finish Studio service can be applied to washbasins from the Slender range, now in a square format, maintaining its characteristic thin edge.

Mediante un proceso artesanal donde el peso de la experiencia de la sensibilidad humana son esenciales, el servicio Finish Studio se aplica en los lavabos de la serie Slender, ahora en su formato cuadrado, manteniendo su característico borde fino.



Carrara marble
Carrara marble



Marfil stone
Marfil stone



Caliza concrete
Caliza concrete



Marquina stone
Marquina stone



Dark concrete
Dark concrete

Unique pieces that require a high level of technical know-how and sensitivity from the artisan developing them.

Piezas únicas que requieren un alto conocimiento técnico y una sensibilidad por parte del artesano que las desarrolla.



Touches of colour and own personality.

This is how we can define the new colours that are delicately applied to and handcrafted in Slender washbasins. Its colours, as elegant as they are joyful, include Pastel Beige and Fusion Grey -providing a subtle touch-, Flamingo Pink, Evening or Arctic Blue and Green Crocodile, for the bolder of users. Cioccolato Brown offers a warmer touch and Jet Black is for those who opt for something neutral. They are a winning choice when it comes to creating a unique and special bathroom.

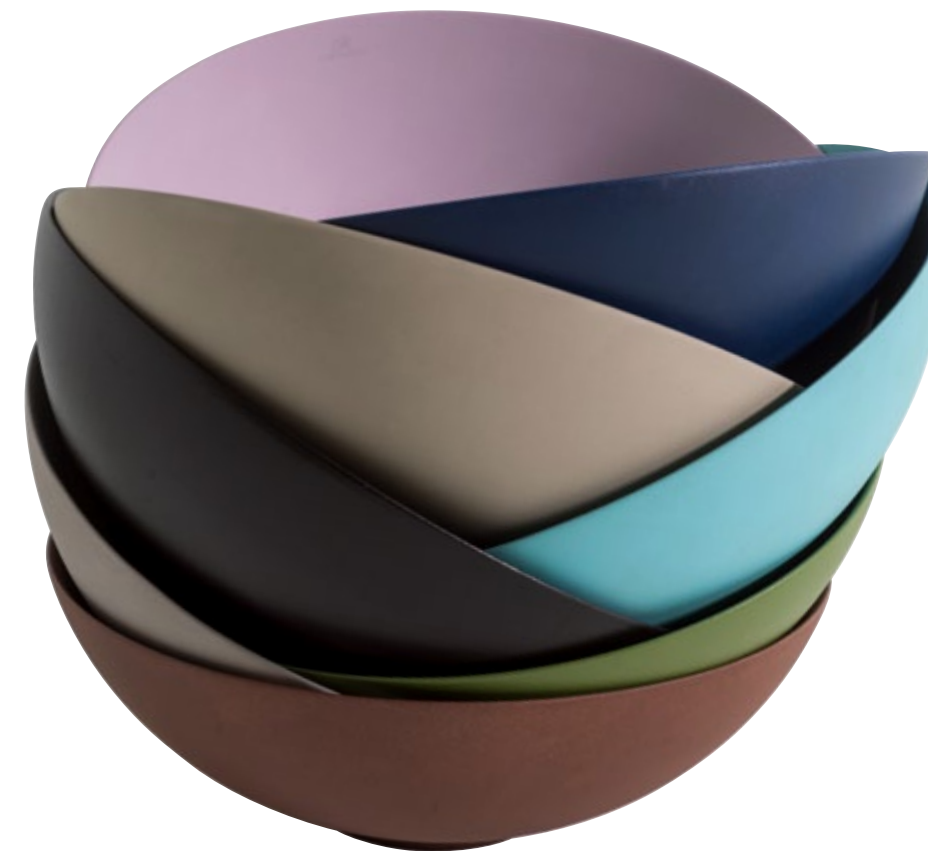

- Pastel Beige
Beige pastel
- Twilight blue
Azul atardecer
- Arctic blue
Azul ártico
- Fusion grey
Gris fusión
- Cioccolato brown
Marrón cioccolato
- Jet black
Negro azabache
- Flamingo pink
Rosa flamenco
- Crocodile green
Verde cocodrilo

Toques de color y personalidad propia.

Así son los nuevos colores aplicados de forma delicada y artesanalmente en los lavabos Slender. Sus colores son tan distinguidos como alegres, empezando por un Beige Pastel y Gris Fusión, añadiendo un toque sutil, pasando por colores como el Rosa Flamenco, Azul Ártico o Atardecer y el Verde Cocodrilo para los más atrevidos. Dejando el Marrón Cioccolato para dar toques más cálidos y el Negro Azabache para los que apuestan por lo neutro. Son una apuesta segura para crear un baño único y especial.

Contracts Line

Installation systems / Sistemas de instalación

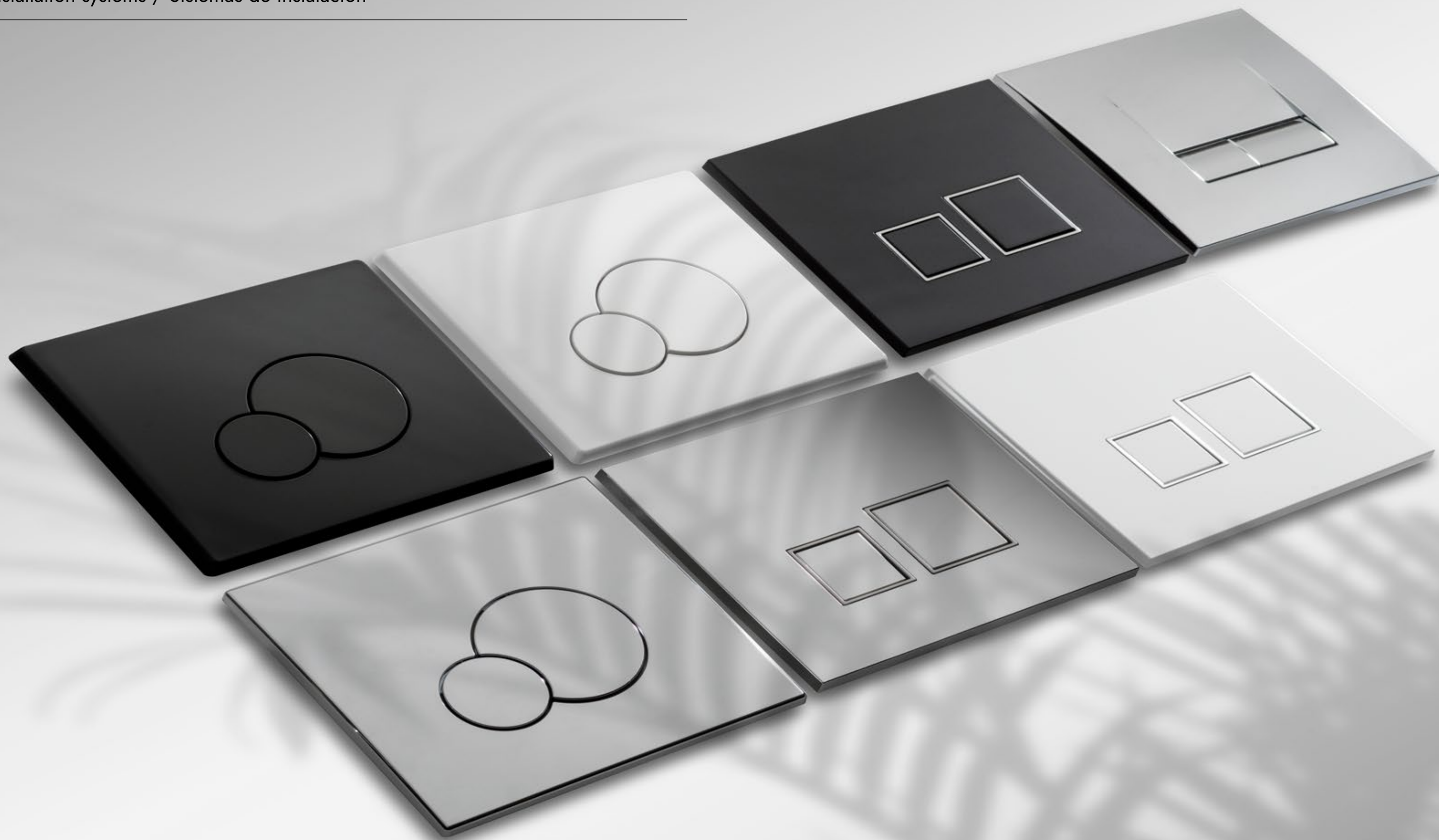

For this new series of installation systems, we wanted to pull together all the essential functions of a wall-mounted WC frame. The result is the ultimate frame for contract projects.

Con esta nueva serie de sistemas de instalación hemos querido reunir todas las funciones esenciales para crear, en suma, un bastidor ideal para proyectos contract.

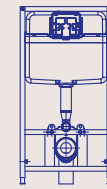

100325910

ECO
100325878

Concealed cistern with frame for wall hung pan. Installation in light wall. Includes the fixings kit and connection pipes for the WC.

Bastidor con cisterna empotrada para inodoro suspendido. Instalación en pared ligera. Incluye kits de fijación y tubos de conexión con el WC.

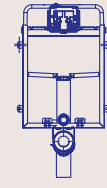

100325879

ECO
100325895

Concealed cistern with frame for wall hung pan. Installation in solid wall. Includes the fixings kit and connection pipes for the WC.

Cisterna empotrada para inodoro suspendido. Instalación en pared sólida. Incluye kit de fijación a muro y tubos de conexión con el WC.

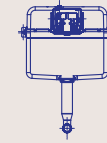

100325920

ECO
100325897

Concealed cistern without frame for floor standing WC pan. Includes the fixings kit and connection pipes for the WC.

Cisterna empotrada para inodoro independiente. Incluye kit de fijación y tubos de conexión con el WC.

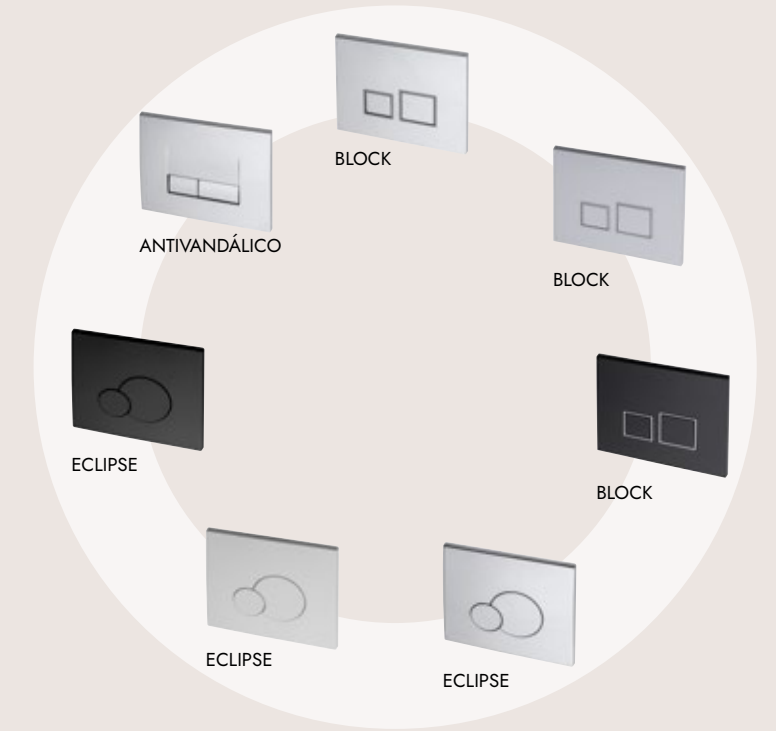

For installation on plasterboard or solid walls.
Para instalación en pared ligera y pared sólida.

400 KG

Frame designed to withstand at least 400 kg.
Bastidor diseñado para soportar al menos 400kg.



Noken Mute System. Silent cistern.
Noken Mute System. Cisterna silenciosa.



Adjustable height.
Altura regulable.



4,5/3L.

Noken Eco-Flush. Save up to 61% of water with the dual-flush system. 4.5/3 and 6/3 litres.
Noken Eco Flush. Ahorra hasta un 61% de agua con el sistema de doble descarga. 4,5/3 y 6/3 litros.

Terra

Towel warmers / Secatoallas





Terra, honouring its name, is a heated towel rail made from recycled marble dust and water-based binders, and is, therefore, a product that joins our **WaterForest** concept. The fibre board used in these products is made under cold temperatures, reducing energy consumption.

Terra, hace honor a su nombre, siendo un secatoallas fabricado con polvo de mármol reciclado y aglutinantes a base de agua, siendo, de este modo, uno de los productos que se une a nuestro concepto **WaterForest**. El aglomerado de estos productos se hace además en frío reduciendo el consumo de energía.

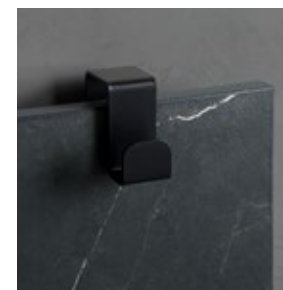

This heated towel rail has a thermal mass that helps control the correct distribution of heat, allowing a quick accumulation to subsequently release it in a gradual manner, creating a warm and satisfactory environment.

Este secatoallas cuenta con una masa térmica que ayuda a controlar la correcta distribución del calor, permitiendo la acumulación en su interior de forma rápida para después liberarlo suavemente, creando un ambiente cálido y satisfactorio.



Finish Studio

Handcrafted decorations, each of them is special and unique. It is entirely painted by hand and features a stone finish, giving the more elegant and simple bathrooms a touch of sophistication.

Decorados de forma artesanal, cada uno de ellos es especial y único. Está pintado íntegramente a mano y con acabado efecto piedra, dando ese toque de sofisticación a los baños más elegantes y sencillos.

-  Carrara marble
Carrara marble
-  Marquina stone
Marquina stone

Oxo

Bathroom furniture / Muebles de baño



The Oxo collection is growing and adding new elements that provide a touch of modernity with their new modules in straight and rectangular lines.

La colección Oxo crece y añade nuevos elementos que dan un plus de modernidad con sus novedades modulares de líneas rectas y rectangulares.



The new Oxo washbasin reaches our catalogue to become one of the stars of 2023, a year in which the futuristic trend and the minimalism of its straight lines continue to be relevant.

El nuevo lavabo Oxo llega a nuestro catálogo para convertirse en uno de los protagonistas este 2023, donde la tendencia futurista y el minimalismo de sus líneas rectas, siguen siendo tendencia.



We have opted for a full personalisation of the bathroom with a totally independent module, allowing the customer to combine different shapes and adding a warm touch to the space, mainly thanks to the natural oak from which it is made, which also provides strength and durability.

Apostamos por la total personalización del baño con un módulo totalmente independiente, dejando al cliente combinar diferentes formas y agregando un toque cálido al espacio, gracias en parte, al roble natural del cual está creado y aportando a la vez durabilidad y resistencia.

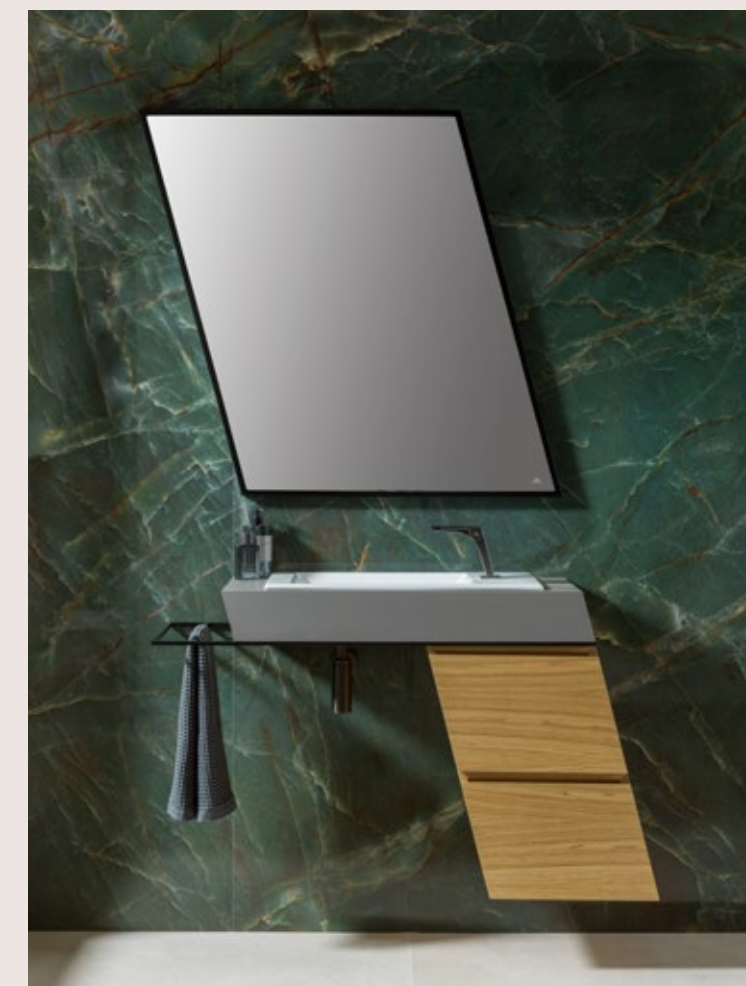
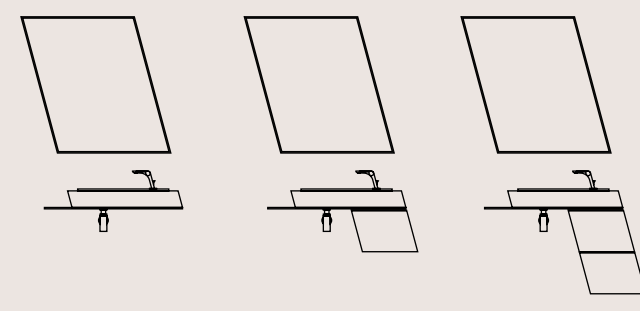

The combination of a black lacquered towel rail and the worktop surface featuring **Project Tech** technology, makes this set as minimalist as it is functional.

La combinación de toallero lacado en color negro, junto con la superficie de la encimera con tecnología **Project Tech**, hace de este conjunto una pieza tan minimalista como funcional.





Ecology, innovation and comfort are the three requirements that underpin our thermostatic shower columns. The **Noken Eco-Flow** technology has been added to personalise the user experience, while contributing to water saving with its flow limiter at 12l/min.

Ecología, innovación y confort son los tres requisitos sobre los que se fundamentan nuestras columnas de ducha termostáticas. **Noken Eco-Flow** se añade y personaliza la experiencia de uso, contribuyendo con su tecnología, al ahorro de agua con su limitador de caudal a 12l/min.



Thanks to its different functions, such as the showerhead with rain effect, an interior output (hidden under the shelf) and the shower hose, the bathroom becomes a place in which to travel to dreamy places, simulating the phenomena of nature.

Con sus diferentes funciones como el rociador con efecto lluvia, una salida interior (oculta debajo del estante) y la teleducha, hacen del baño un lugar donde poder conectar con lugares soñados, simulando los fenómenos de la naturaleza.

Black
Negro

Brushed titanium
Titanio cepillado



Aerodynamic, futuristic and rectangular shapes come together in the new Oxo bathtub. A new avant-garde addition that stands out thanks to its perfectly studied ergonomics and rectangular lines, giving the bathroom a modern touch, without sacrificing the necessary comfort.

Las formas aerodinámicas, futuristas y rectangulares toman forma con la nueva bañera Oxo. Una nueva incorporación vanguardista que no pasa desapercibida gracias a su ergonomía perfectamente estudiada y a sus líneas rectangulares, dando al baño ese toque moderno, sin perder el confort necesario.



Forma

Bathroom furniture / Muebles de baño



archiproducts
DESIGN AWARDS
2022

WINNER



Comfort and simplicity are important properties for Noken when it comes to making sure that the customer feels comfortable in the bathroom. The new Forma mirror includes a support for a cosmetic mirror, making it more functional and practical.

La comodidad y la facilidad para Noken son propiedades importantes para que el cliente esté cómodo en su estancia en el baño. El nuevo espejo Forma incluye un soporte para un espejo de aumento, haciéndolo más funcional y práctico.

Project Tech countertop features

Características de la encimera Project Tech

<p>Low light reflectivity Reflectancia mínima</p> 	<p>Anti bacterial Antibacterias</p> 
<p>Resistance dry heat Resistencia al calor seco</p> 	<p>Anti fingerprint Antihuella</p> 
<p>Resistance to impact Resistencia al impacto</p> 	<p>Easy to clean Fácil limpieza</p> 
<p>Resistance to scratch Resistencia al rayado</p> 	<p>Hydro repellent Hidrófugo</p> 
<p>Rub resistance Resistencia a la fricción regular</p> 	<p>Light fastness Estabilidad a la luz</p> 
<p>Soft touch Suave al tacto</p> 	<p>High resistance to acid solvents Alta resistencia a productos químicos</p> 
<p>Thermal healing Reparabilidad térmica de microarañazos</p> 	<p>High temperature Estabilidad a elevada variación térmica</p> 

Available colours

Colores disponibles

	Almond Almond
	Merlot Merlot
	Forest Forest

The Forma bathroom unit, with its added storage space and wall mirror, bring the calm ambience we need in a space dedicated to wellbeing and self-care.

El mueble de baño Forma, con su plus de almacenaje y su espejo a pared, crean una atmósfera de calma tan necesaria en un lugar creado para el autocuidado y el bienestar.



This new countertop solution provides more storage inside the unit, so you have space for all your everyday essentials.

Esta nueva opción con lavabo de apoyo nos permite contar con más almacenaje en el interior del mueble para guardar los elementos básicos del día a día.



It adds personality to the bathroom by combining the handcrafted Slender washbasins with Round taps and their new **Finish Studio** handles.

Aporta personalidad en el baño combinando los artesanales lavabos Slender con la grifería Round y sus nuevas manetas **Finish Studio**.





Lounge

Bathroom furniture / Muebles de baño



A more practical and aesthetic design than ever before has landed in our catalogue to become one of the stars for 2023, with the trend for the value of functionality and warm minimalism.

Un diseño más práctico y más estético que nunca, llega a nuestro catálogo para convertirse en uno de los protagonistas este 2023, donde el valor de la funcionalidad y el minimalismo cálido, son tendencia.

The combination of natural maple wood with the **Project Tech** surface makes this bathroom vanity as comfortable as it is resistant and antibacterial.

La combinación de la madera natural de arce con la superficie de **Project Tech** hace de este mueble una pieza tan confortable como resistente y antibacteriana.





Elegance embodied in taps that combine design and ecology. Making these such dissimilar terms a necessary fusion in our bathrooms. A thermostatic shower column with an **AISI 304 stainless steel structure**, together with a tempered glass shelf, create an excellent atmosphere when accompanied by the rain effect, which transports us to the Earth's innermost nature.

La elegancia hecha grifería combinando diseño y ecología. Haciendo de estos términos tan dispares una fusión necesaria en nuestros baños. Una columna de ducha con función termostática y **estructura de acero inoxidable AISI 304**, junto con una repisa de vidrio templado, crean una atmósfera excelente acompañada del efecto lluvia, que nos transporta a la naturaleza más profunda de la Tierra.

The Lounge collection has been updated and dyes our bathrooms in matt black.

La colección Lounge se actualiza y tiñe en negro mate nuestros baños.



The taps with straight lines and special finish in colour add a touch of sophistication, character and elegance to our most intimate environments. They are trending hard and are here to stay.

La grifería de líneas rectas, con su especial acabado en color, da un toque de sofisticación, carácter y elegancia a nuestros ambientes más íntimos, creando una tendencia que pisa con fuerza y dispuesta a quedarse.



Both the toilet and bidet are an important part of the bathroom due to their recurrent use. This is why the Lounge collection is offering in the bathroom the option of a floor standing toilet and bidet in matt black featuring the **Noken Clean Rimless** technology, a highly efficient cleaning system with an innovative design that allows water to circulate around the toilet.

Tanto el inodoro como el bidé, son importantes para el baño debido a su uso recurrente.

Es por eso, que la colección Lounge, ofrece a nuestros sanitarios la opción de bidé e inodoro a suelo en negro mate con el plus de la tecnología de **Noken Clean Rimless**. Un sistema de limpieza para inodoros de alta eficiencia que innova en su diseño y propone una nueva forma para la circulación del agua.

Free-standing bathtubs are the queens of bathroom fixtures and currently more on trend than ever.

Finish Studio is applied to the Lounge Concrete oval-shaped bathtub, with a white interior and front in colour. The microcement texture on the outer side of the bathtub brings us closer to a more industrial style. These new skins and textures allow us to choose any style and personalise our bathroom.

Las bañeras exentas son las reinas del equipamiento de baño y ahora, son más tendencia que nunca.

Finish Studio se aplica a la bañera Lounge Concrete de forma oval, dejando el interior en color blanco y aplicando color en el faldón. La textura microcemento, del exterior de la bañera, nos acerca al estilo más industrial. Estas nuevas pieles y texturas, nos ayudan a poder escoger cualquier estilo y personalizar cada vez nuestro baño.



Arquitect

Bathroom furniture / Muebles de baño



A collection of soft, versatile and highly functional lines.

Una colección de líneas suaves, versátil y altamente funcional.

Constantly reinventing itself, this bathroom series dons its finery to surprise the more exclusive of bathrooms. Elegant and practical pieces that perfectly connect with each other and allow creating a complete bathroom with a high dose of modernity.

Constantemente en continua reinención, esta serie de baño se viste de gala para sorprender a los baños más exclusivos. Piezas elegantes y prácticas que conectan perfectamente entre sí y que permiten crear un baño completo y con altas dosis de modernidad.





The new 140-cm unit stands out for its support surface, which has been appropriately treated with nanotechnology and now features innovative and totally revolutionary characteristics. In perfect combination with the 42-cm Arquitect washbasin, we obtain the perfect balance between functionality and design.

El nuevo mueble de 140 cm destaca por su superficie de apoyo, correctamente tratada mediante nanotecnología, otorgando unos atributos innovadores y de total revolución. En combinación perfecta con el lavabo Arquitect de 42 cm, nos dan el equilibrio perfecto entre funcionalidad y diseño.

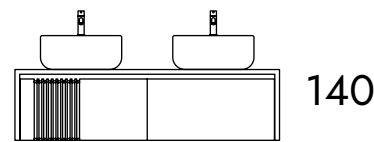

140



White
Blanco

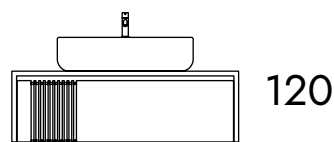

120



Grey
Gris

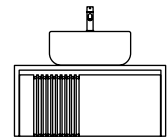

80



Black
Negro

The rounded and modern lines of both the Arquitect toilet and bidet combine perfectly with any bathroom, thanks to their discreet aesthetic, based on a simplicity of shapes and the pursuit of maximum spaciousness and visual cleanliness. In colour and wall-mounted, they adapt to any bathroom layout, space or style, allowing you to make the most of the capacity and size of your bathroom.

Las líneas redondeadas y modernas, tanto del inodoro como del bidé Arquitect, combinan a la perfección con cualquier baño, gracias a su estética discreta, basada en la sencillez de las formas y la búsqueda de la máxima limpieza visual y amplitud. Siendo de color blanco y suspendidos, se adaptan a cualquier distribución de baño, espacio y estilo, permitiendo, además, aprovechar al máximo la capacidad del baño.



NOKEN CLEAN RIMLESS



EASY CLEANING
FÁCIL LIMPIEZA



EFFICIENT FLUSH
DESCARGA EFICIENTE



NO SPLASHING
SIN SALPICADURAS



MORE SILENT
MÁS SILENCIOSO

NK Concept



Bathroom furniture / Muebles de baño





The NK Concept unit adds extra versatility by incorporating straight handles in chrome finish for those looking for clean and linear surfaces. It also includes round handles in matt black finish for customers who prefer more organic and fluid shapes. Both are perfectly integrated with the taps in the environment.

El mueble Nk Concept, añade un extra de versatilidad con la incorporación de los tiradores en formas rectas y acabado en cromo, para los que buscan superficies limpias y lineales. A la vez, incluyen los tiradores redondos en acabado negro mate, para los clientes que buscan formas más orgánicas y fluidas. Ambos se integran a la perfección con la grifería en el ambiente.

-  Grey oak
Roble gris
-  White
Blanco



Designed for maximum comfort and functionality.

Diseñado para el máximo confort y funcionalidad.

In line with our values, the Alma bathtub, with a minimalist design and perfectly studied ergonomics, features a specific backrest that better rests the lumbar area, providing further comfort and a relaxing bath.

Siguiendo con nuestros valores, la bañera Alma, con un diseño minimal y una ergonomía estudiada a la perfección, está diseñada con un respaldo específico, buscando un mejor descanso de la zona lumbar, para mayor confort del usuario y disfrutar de un baño relajante.



Noken's passion for offering innovative products that are also environmentally friendly is perfectly embodied in the NK Concept taps. A complete series of washbasin, bidet, high spout and wall basin taps, featuring a current design and the most advanced ECO technology to create this range of environmentally friendly products.



La pasión de Noken por ofrecer productos innovadores a la vez que respetuosos con el medioambiente, se materializa a la perfección en la grifería de NK Concept. Una completa serie de griferías de lavabo, bidé, caño alto y lavabo a muro, caracterizadas por un diseño actual y el uso de la tecnología ECO más avanzada para la creación de esta gama de productos cuidadosos con el entorno.



New accessories have been added to our catalogue. NK Concept, makes daily life easier thanks to its functionality and strategic location. From towel racks and hangers to object holders and a multitude of carefully designed elements that make the bathroom a captivating space.

Nuevos accesorios se incorporan a nuestro catálogo. Nk Concept, facilita la vida diaria gracias a su funcionalidad y ubicación estratégica. Desde toalleros y colgadores a portaobjetos y un sinnúmero de elementos con diseño cuidado, que hacen del baño un espacio para el deleite.



-  Chrome
Cromo
-  Matt black
Negro mate

The NK Concept bathroom series, consisting of white washbasins, toilets and bidets, among others, and with the option of a double sink, perfectly integrates into the most minimalist and modern bathrooms.

La serie NK Concept de baño, compuesta, entre otros, por lavabos, inodoros y bidés en colores blanco y con la opción del lavabo doble, se integran perfectamente a los baños más minimalistas y modernos.



noken

PORCELANOSA BATHROOMS

NOKEN DESIGN, S.A.U. CV-20 km. 2
12540 - Vila-real - Castellón - Spain

Tel: +34 964 50 64 50
e-mail: noken@noken.com
www.noken.com



NOKEN DESIGN, S.A.U. The contents of this catalogue are protected by virtue of the Spanish Intellectual Property Act, Royal Legislative Decree 1/1996. The partial or total reproduction of this catalogue, without the express authorisation of NOKEN DESIGN, S.A.U. is punishable under the Spanish Criminal Code. Reserves the right to cancel and/or change models or accessories without prior notice or replacement. The settings shown in this catalogue are design proposals for advertising purposes. In real situations in which the tiles are laid, we recommend to use as a guide for the installation, the technical specifications available on the Noken GENERAL RATE.

NOKEN DESIGN, S.A.U. El contenido de este catálogo está protegido por la Ley de Propiedad Intelectual, Real Decreto Legislativo 1/1996. Cualquier reproducción del mismo, en parte o en su totalidad, sin autorización expresa de NOKEN DESIGN, S.A.U. puede ser sancionada conforme el Código Penal. Se reserva el derecho legal de anular y/o aportar posibles modificaciones a sus productos y accesorios sin previo aviso ni sustitución. Los ambientes que se muestran en este catálogo son sugerencias decorativas de carácter publicitario, debiéndose utilizar como guía para la instalación, las fichas técnicas que se encuentran en la TARIFA GENERAL editada por Noken.

Graphic Design _ Marketing department by Noken

Art Direction _ Marketing department by Noken

Photography _ Marketing department by Noken

Publisher _ Noken Design, S.A.U.

February _ 2023



BY APPOINTMENT TO
H.R.H. THE PRINCE OF WALES
MANUFACTURER AND DISTRIBUTOR
OF CERAMIC TILES AND BUILDING PRODUCTS.
PORCELANOSA GROUP LIMITED

PORCELANOSA Grupo